



# Multicrafts Corporation

Kotli Behram, Khadim Ali Road  
P.O. Box 949, Sialkot 51310 Pakistan  
Tel: +92 52 426 4892  
Fax: +92 52 426 4692  
@: info@multicrafts.com.pk  
<http://www.multicrafts.com.pk>



**Dental Instruments**

**Multicrafts Corporation**

MULTICRAFTS

CORPORATION



# Multicrafts

## Corporation

**P.O. Box 949, Sialkot 51310 Pakistan**

Kotli Behram, Khadim Ali Road Tel: +92 4264892 Fax: +92 52 4264692

@: info@multicrafts.com.pk <http://www.multicrafts.com.pk>



## Dental



**1402/17**  
15,5 cm

**1402/33**  
15,5 cm

**1402/23**  
15 cm

Rundgriff massiv  
Round handle solid  
Manche rond massive  
Mango redando sólido  
Manico tondo solida



**1410/1**  
15 cm

Achtkantgriff massiv / gerieft  
Octagonal handle solid / serrated  
Manche octogonal massive / striée  
Mango octogonal sólido / estriado  
Manico ottagonale solida / zigrinate



**1410/2**  
15 cm



**1410/30**  
15 cm



**1410/32**  
14,5 cm



**1410/33**  
15 cm



**1410/34**  
15 cm



**1410/43**  
15 cm



**1410/44**  
15 cm



**1415/33**  
15 cm



**1420/33**  
15 cm

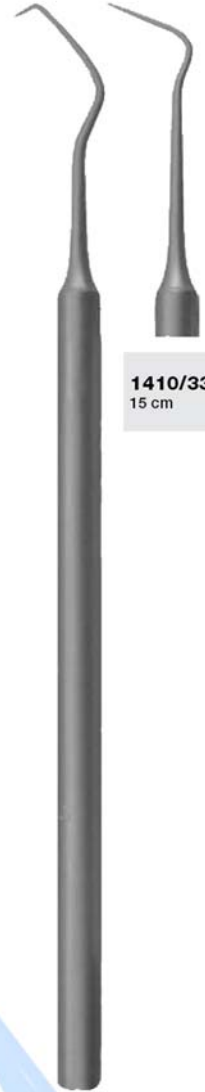

**1410/33 G**  
15 cm

**1410/17 G**  
15 cm

Rundgriff massiv  
Round handle solid  
Manche rond massive  
Mango redando sólido  
Manico tondo solida



**1410/32 SE**  
3,5 cm

Sonden auswechselbar  
Explorers interchangeable  
Sondes échangeables  
Sondas cambiables  
Sonde sostituire



**1410/33 SE**  
4 cm

Einsatz für Mundspiegelgriffe S. 11  
Insert for mouth mirror handle S. 11  
Insert pour manches à miroirs S. 11  
Pieza de inserción para mangos a espejos S. 11  
Inserto per manici specchietti S. 11



**1410/33 P**

16,5 cm

Hohlgriff  
Hollow Handle  
Poignée creuse  
Mango hueco  
Manico cavo



**1410/33 R**

15 cm

Rundgriff massiv  
Round handle solid  
Manche rond massive  
Mango redando sólido  
Manico tondo solida



**1435/5**

17 cm

Achtkantgriff / massiv / glatt  
Octagonal handle / solid / smooth  
Manche octogonale / massive / lisse  
Mango octogonal / sólido / lisa  
Manico ottagonale / solida / liscie



**1435/7**

16,5 cm

Achtkantgriff / massiv / gerieft  
Octagonal handle / solid / serrated  
Manche octogonale / massive / striée  
Mango octogonal / sólido / estriado  
Manico ottagonale / solida / zigrinate



**1440/5**

16,5 cm

Achtkantgriff / massiv / gerieft  
Octagonal handle / solid / serrated  
Manche octogonale / massive / striée  
Mango octogonal / sólido / estriado  
Manico ottagonale / solida / zigrinate



**1455/1**

Lange  
16,5 cm

Rundgriff / massiv  
Round handle / solid  
Manche rond massive  
Mango redando sólido  
Manico tondo solida



**1440/5 A**

16,5 cm



**1440/5 AR**

16,5 cm

Rundgriff / massiv  
Round handle / solid  
Manche rond massive  
Mango redando sólido  
Manico tondo solida

# Dental



# MULTICRAFTS Corporation

## Dental

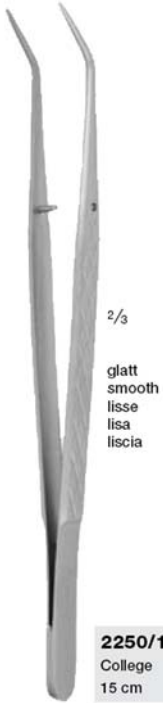

2/3  
glatt  
smooth  
lisse  
lisa  
liscia

**2250/1**  
College  
15 cm

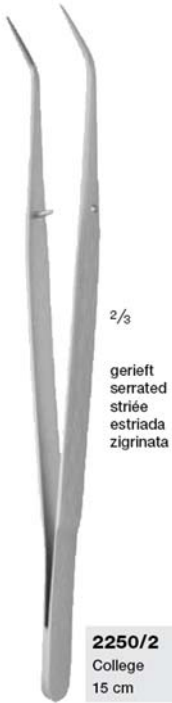

2/3  
gerieft  
serrated  
striée  
estriada  
zigrinata

**2250/2**  
College  
15 cm



2/3  
gerieft  
serrated  
striée  
estriada  
zigrinata

**2255/2**  
College  
15 cm



2/3  
gerieft  
serrated  
striée  
estriada  
zigrinata

**2272/2**  
College modif.  
15 cm

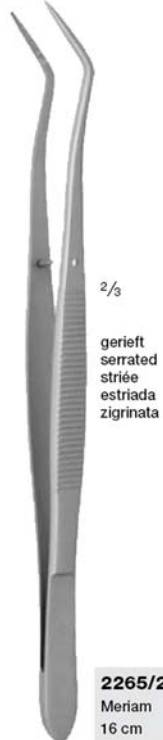

2/3  
gerieft  
serrated  
striée  
estriada  
zigrinata

**2265/2**  
Meriam  
16 cm



2/3  
diamantierte Spitzen  
diamonded tips  
pointes diamantées  
puntas diamantadas  
punte diamantate

**2265 D**  
Meriam  
16 cm



2/3  
gerieft  
serrated  
striée  
estriada  
zigrinata

**2275/2**  
Flagg  
16 cm



2/3  
gerieft  
serrated  
striée  
estriada  
zigrinata

**2295/2**  
14,5 cm



2/3  
gerieft  
serrated  
striée  
estriada  
zigrinata

**2285/2**  
Perry  
13 cm



**2380**  
12,5 cm

hohl verchromt  
hollow chromium  
plated creux chromé  
hueco cromado  
cavo cromato



**2382**  
12 cm

massiv  
solid  
massive  
sólido  
solida



**2384**  
14 cm

Hohlgriff  
Hollow Handle  
Poignée creuse  
Mango hueco  
Manico cavo



**2390**  
13 cm

Hohlgriff  
Hollow Handle  
Poignée creuse  
Mango hueco  
Manico cavo



**2395**  
13,5 cm

Kunststoffgriff grün  
Plastic handle green  
Manche à plastique vert  
Mango plastico verde  
Manico plastica verde

**2395 B**  
13,5 cm

Kunststoffgriff blau  
Plastic handle blue  
Manche à plastique bleu  
Mango plastico amaratado  
Manico plastica blu

**2395/1**  
13,5 cm

Kunststoffgriff schwarz  
Plastic handle black  
Manche à plastique noir  
Mango plastico negro  
Manico plastica nero



**2399**  
13,5 cm

Hohlgriff  
Hollow Handle  
Poignée creuse  
Mango hueco  
Manico cavo

**2399 A**  
Cone-Socket  
13 cm

Hohlgriff  
Hollow Handle  
Poignée creuse  
Mango hueco  
Manico cavo

## Dental



**2340/4** \*3)  
ø 22 mm

**2342/4** \*1)  
ø 22 mm



**2350/4** \*3)  
ø 22 mm

**2350/5** \*3)  
ø 24 mm

**2352/4** \*1)  
ø 22 mm

**2352/5** \*1)  
ø 24 mm

**2360/4** \*2,3)  
ø 22 mm

**2360/5** \*2,3)  
ø 24 mm

**2362/4** \*1,2)  
ø 22 mm

**2362/5** \*1,2)  
ø 24 mm



**2370/4** \*3)  
ø 22 mm

**2370/5** \*3)  
ø 24 mm

**2372/4** \*1)  
ø 22 mm

**2372/5** \*1)  
ø 24 mm



**2374/4** \*1,4)  
ø 22 mm  
Rhodium

**2374/5** \*1,4)  
ø 24 mm  
Rhodium



**2377/4** \*1,4)  
ø 22 mm  
Rhodium



**2378/4** \*1,4)  
ø 22 mm  
HR-Front

**2378/5** \*1,4)  
ø 24 mm  
HR-Front

\*1) plan / plane / plan / plano / piano  
\*2) hauchfrei / not tarnishing / antibuée / no empanan / privo di profumo  
\*3) vergrößernd / magnifying / agrandissant / de aumento / concavo  
\*4) absolut verzerrungsfreies Spiegelbild / absolutely distortion-free mirror image  
image réfléchi sans aucune distorsion / imagen reflejada totalmente libre de distorsión  
immagine riflessa assolutamente priva die distorsioni





<b>EXC 1 Z</b> # 17 16 cm	<b>EXC 1 SZ</b> 16 cm	<b>EXC 11 Z</b> # 11 16 cm
---------------------------------	--------------------------	----------------------------------

Neuer LIGHTWEIGHT Griff  
 New LIGHTWEIGHT handle  
 Neuf manche LIGHTWEIGHT  
 Nuevo mango LIGHTWEIGHT  
 Nuovo manico LIGHTWEIGHT

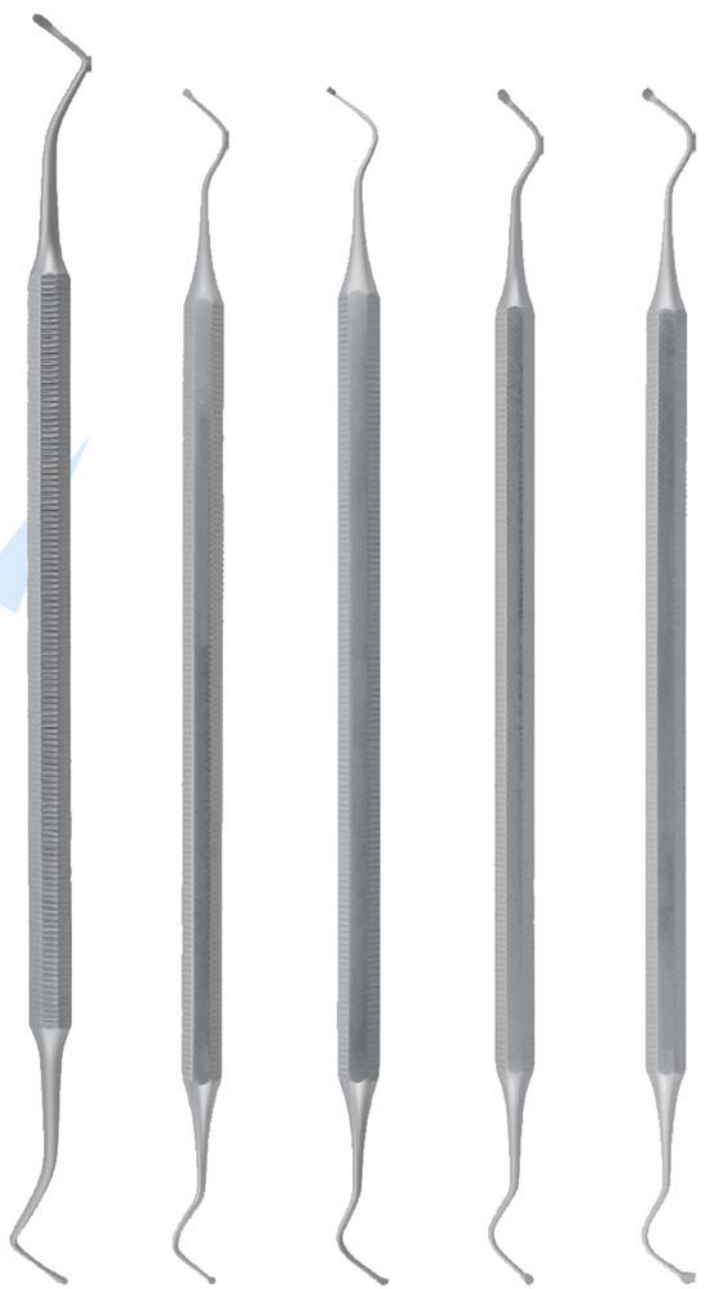

<b>1290/17</b> White 17 cm	<b>1295-45-46</b> #45-46 16 cm	<b>1295-51-52</b> #51-52 16 cm	<b>1295-63-64</b> #63-64 16 cm	<b>1295-81-82</b> #81-82 16 cm
----------------------------------	--------------------------------------	--------------------------------------	--------------------------------------	--------------------------------------

Achtkantgriff / massiv / gerieft  
 Octagonal handle / solid / serrated  
 Manche octogonale / massive / striée  
 Mango octagonal / sólido / estriado  
 Manico ottagonale / solida / zigrinate

## Dental



## Dental

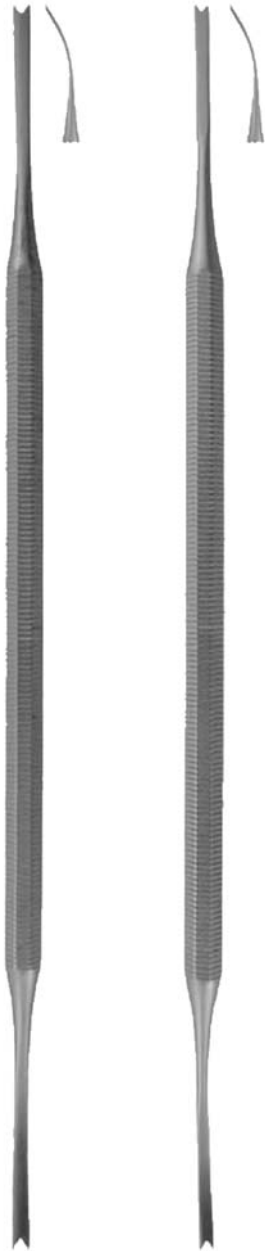

**1020/1**  
Luniatschek  
18 cm

Tamponstopfer  
Gauze Packer  
Porte Tampon  
Tamponadore  
Reggitampone

Achtkantgriff / massiv / gerieft  
Octagonal handle / solid / serrated  
Manche octagonal / massive / striée  
Mango octagonal / sólido / estriado  
Manico ottagonale / solida / zigrinate

**1020/2**  
Luniatschek  
18 cm

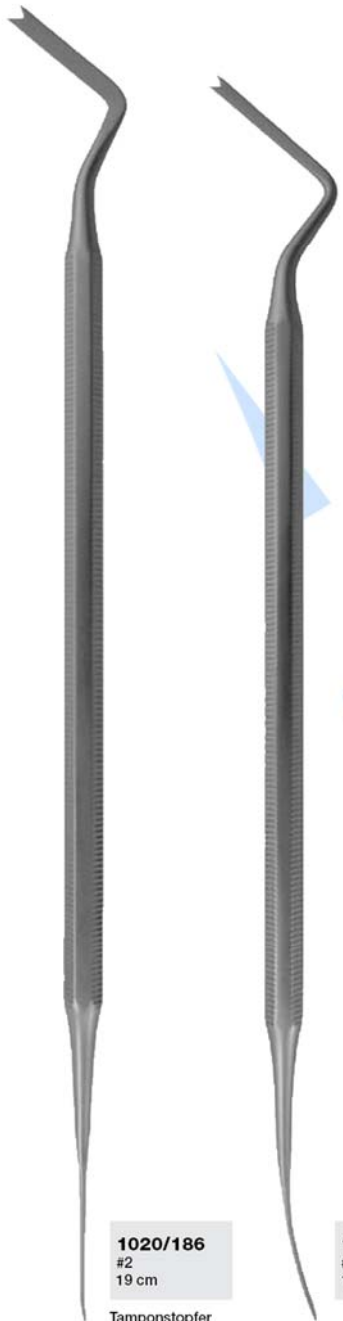

**1020/186**  
#2  
19 cm

Tamponstopfer  
Gauze Packer  
Porte Tampon  
Tamponadore  
Reggitampone

Achtkantgriff / massiv / gerieft  
Octagonal handle / solid / serrated  
Manche octagonal / massive / striée  
Mango octagonal / sólido / estriado  
Manico ottagonale / solida / zigrinate

**1020/204**  
#2521  
18 cm

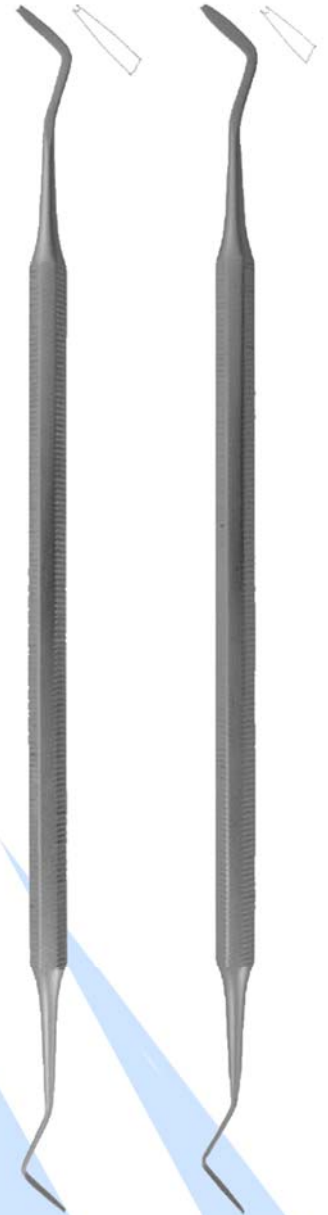

**1020/6**  
17,5 cm

Fadenleger  
Thread Packer  
Porte-fil  
Introductor de hilo  
Strumenti per fili die retrazione

Achtkantgriff / massiv / gerieft  
Octagonal handle / solid / serrated  
Manche octagonal / massive / striée  
Mango octagonal / sólido / estriado  
Manico ottagonale / solida / zigrinate

**1020/7**  
17,5 cm

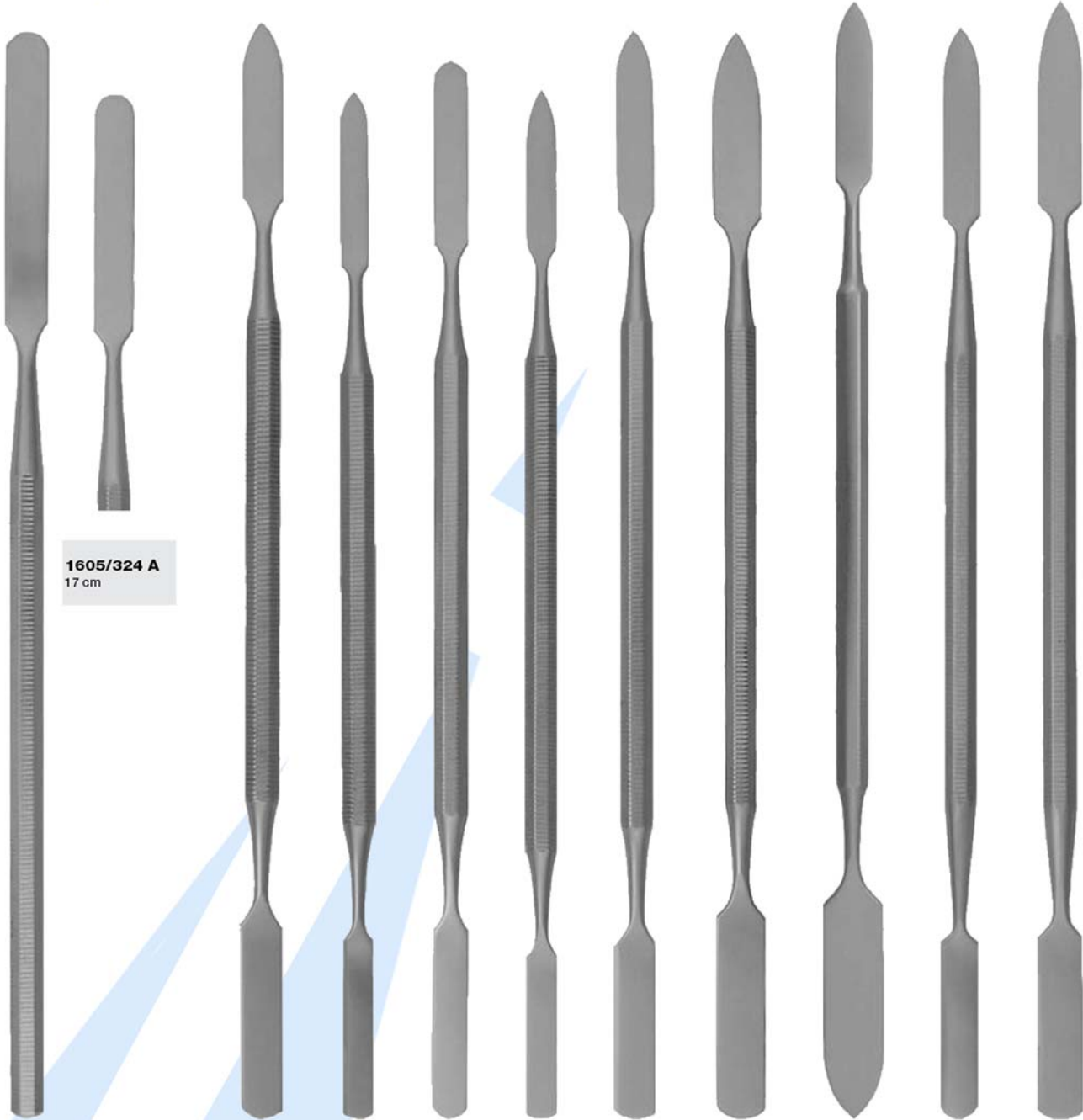

**1605/324 A**  
17 cm

**1605/324**  
18 cm

**1650/1**  
18 cm

**1650/2**  
17 cm

**1650/3**  
17,5 cm

**1655/1**  
17 cm

**1655/2**  
18 cm

**1655/3**  
18 cm

**1655/4**  
18,5 cm

**1660/2**  
18 cm

**1660/4**  
18,5 cm

Achtkantgriff / massiv / gerieft  
 Octagonal handle / solid / serrated  
 Manche octogonale / massive / striée  
 Mango octagonal / sólido / estriado  
 Manico ottagonale / solida / zigrinate

## Dental

Dental



**1276/1**

10,5 cm

Rundgriff / massiv  
Round handle / solid  
Manche rond / massive  
Mango redondo / sólido  
Manico tondo / solida



**1700/1**

**1700/1 TI\* 1 )**  
ø0,8/ø1,2 mm  
17 cm

Kugelstopfer  
Ball-type condenser  
Oburateur à bille  
Condensador tipo bola  
Otturatore a sfera



**1700/2**

**1700/2 TI\* 1 )**  
ø1,2/ø1,8 mm  
17 cm

Achtkantgriff / massiv / gerieft  
Octagonal handle / solid / serrated  
Manche octagonal / massive / striée  
Mango octagonal / sólido / estriado  
Manico ottagonale / solida / zigrinate



**1700/3**

**1700/3 TI\* 1 )**  
ø1,8/ø2,4 mm  
17 cm

\* 1 )  
titanbeschichtet / nicht haftend  
titanium-coated / non-adhesive  
recouvert de titane / non -adhésif  
con revestimiento de titanio / no adhesivo  
con rivestimento in titanio / non adesivo



**1700/4**

ø2,4/ø3,2 mm  
17 cm



**2010/26-29**

White  
17 cm

Polierinstrument  
Polisher  
Polissoir  
Instrumento para pulir  
Lucidatore



**2010/29-31**

White  
17 cm

Achtkantgriff / massiv / gerieft  
Octagonal handle / solid / serrated  
Manche octagonal / massive / striée  
Mango octagonal / sólido / estriado  
Manico ottagonale / solida / zigrinate

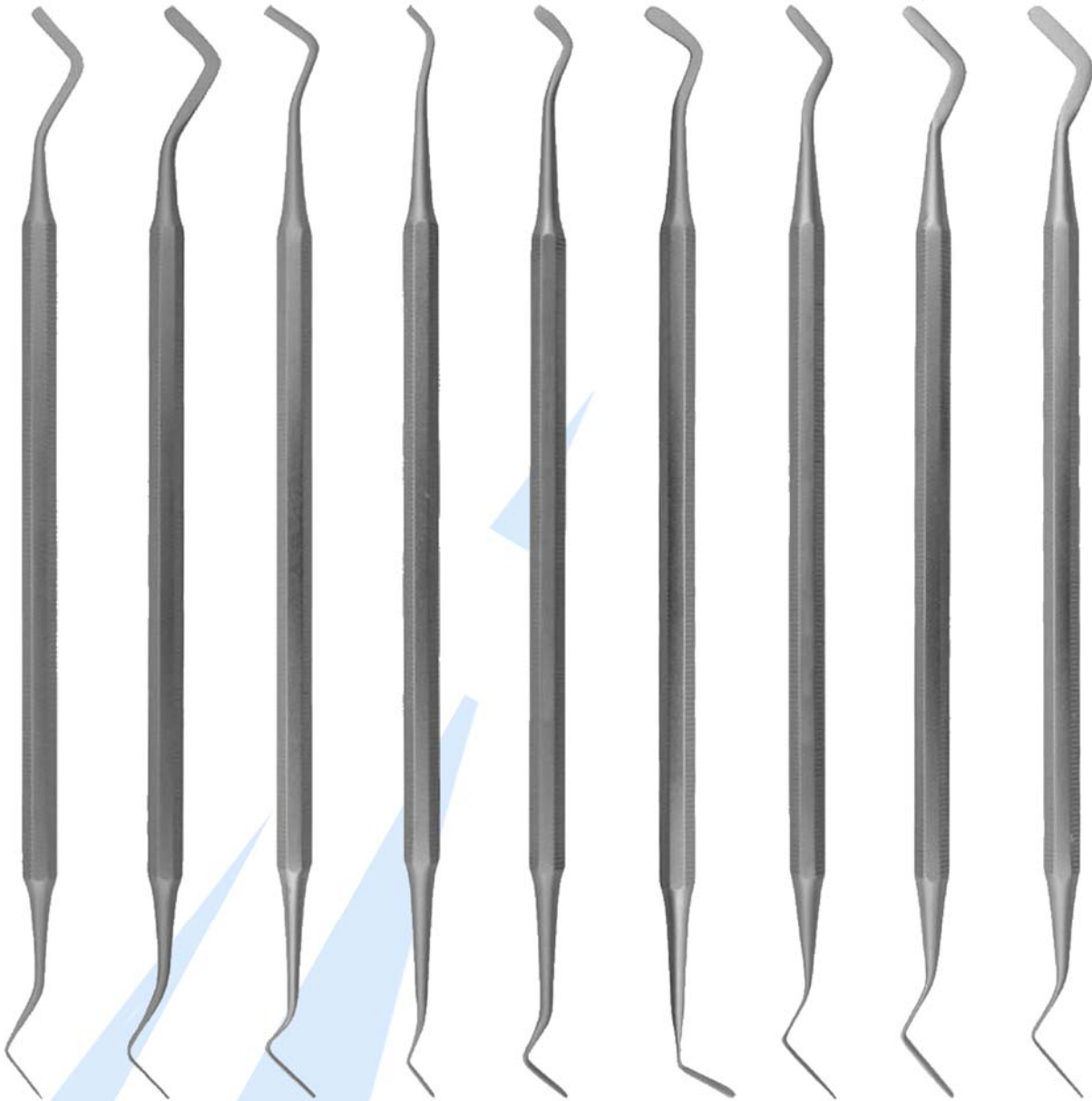

<b>1700/13</b>	<b>1700/14</b>	<b>49 F</b>	<b>1900/0</b> <b>1900/0 TI*1)</b>	<b>1900/1</b>	<b>1900/6</b>	<b>1960/1</b> <b>1960/1 TI*1)</b> Heidemann	<b>1960/2</b> <b>1960/2 TI*1)</b> Heidemann	<b>1960/3</b> Heidemann
1,5/1,5 mm 17 cm	2,0/2,0 mm 17 cm	2,5/1,8 mm 17,5 cm	1,4/2,0 mm 17 cm	2,0/2,0 mm 17 cm	2,6/3,2 mm 17 cm	2,1/2,1 mm 17 cm	2,7/2,7 mm 17 cm	3,1/3,1 mm 17 cm

Spatel  
Spatula  
Spatule  
Espátula  
Spatole

Achtkantgriff / massiv / gerieft  
Octagonal handle / solid / serrated  
Manche octogonale / massive / striée  
Mango octagonal / sólido / estriado  
Manico ottagonale / solida / zigrinata

\* 1)  
titanbeschichtet / nicht haftend  
titanium-coated / non-adhesive  
recouvert de titane / non-adhésif  
con revestimiento de titanio / no adhesivo  
con rivestimento in titano / non adesivo



## Dental



**1960/1 G**  
2,1/2,1 mm  
Heidemann  
17,5 cm

Spatel  
Spatula  
Spatule  
Espátula  
Spatole



**1960/2 G**  
2,7/2,7 mm  
Heidemann  
17,5 cm

Rundgriff / massiv  
Round handle / solid  
Manche rond / massive  
Mango redando / sólido  
Manico tondo / solida



**1960/11 R**  
1,4/1,4 mm  
Heidemann  
17,5 cm

Spatel  
Spatula  
Spatule  
Espátula  
Spatole

Rundgriff / massiv / gerieft  
Round handle / solid / serrated  
Manche rond / massive / striée  
Mango redando / sólido / estriado  
Manico tondo / solida / zigrinate



**1960/1 R**  
**1960/1 R TI\*1)**  
2,1/2,1 mm  
Heidemann  
17,5 cm



**1960/8 R**  
2,5/2,5 mm  
Heidemann  
17,5 cm



**1790/21**  
**1790/21 TI\*1)**  
2,4/2,8 mm  
17 cm

Achtkantgriff / massiv / gerieft  
Octagonal handle / solid / serrated  
Manche octogonal / massive / striée  
Mango octogonal / sólido / estriado  
Manico ottagonale / solida / zigrinate



**1790/21 B**  
3,0/3,4 mm  
Westcott  
17 cm

\*1)  
titanbeschichtet / nicht haftend  
titanium-coated / non-adhesive  
recouvert de titane / non-adhésif  
con revestimiento de titanio / no adhesivo  
con rivestimento in titanio / non adesivo



**1700/35**  
**1700/35 TI\* 1)**  
0,9/1,2 mm  
17 cm



**1700/36**  
**1700/36 TI\* 1)**  
1,2/1,6 mm  
17 cm

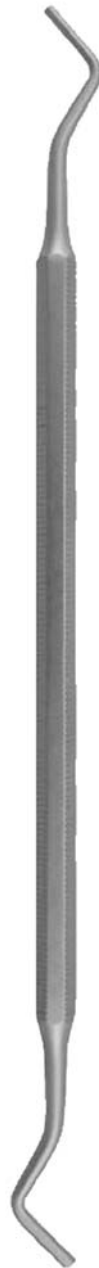

**1700/37**  
1,6/2,1 mm  
17 cm



**1750/1-2**  
2,0/2,5 mm  
17 cm

\* 1)  
titanbeschichtet / nicht haftend  
titanium-coated / non-adhesive  
recouvert de titane / non-adhésif  
con revestimiento de titanio / no adhesivo  
con rivestimento in titanio / non adesivo

Achtkantgriff / massiv / gerieft  
Octagonal handle / solid / serrated  
Manche octagonal / massive / striée  
Mango octagonal / sólido / estriado  
Manico ottagonale / solida / zigrinate

# Dental



## Dental



**2421**  
13 cm

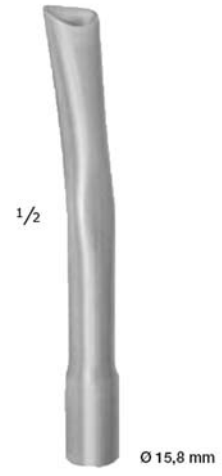

**2421/3**  
13 cm



**2422**  
19 cm



**2423**  
18,5 cm



**2425**  
14 cm

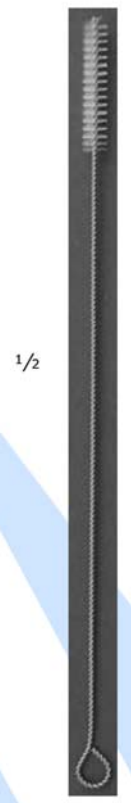

**2424 B**  
16 cm





**2400/4**  
Ivory  
20 cm



**2477**  
Tofflemire  
6 cm



**2477/1**  
Tofflemire  
6 cm



**2477/2**  
Tofflemire  
6 cm



**2477/3**  
Tofflemire  
6 cm



**2582**  
Miller  
15,5 cm



**2583**  
Miller  
15,5 cm

## Dental



**Dental**



**2550/1**  
Ainsworth  
16,5 cm

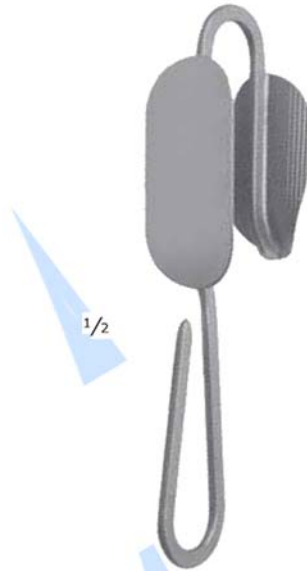

1/2

**110**  
15 cm  
Scheufele



1/2

**120**  
17 cm  
Scheufele

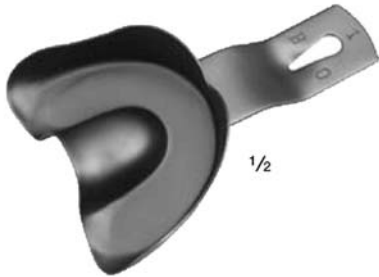

1/2

5101 = Fig. 1  
5102 = Fig. 2  
5103 = Fig. 3  
5104 = Fig. 4

**Form BO (SUP/B)**  
für bezahnte Oberkiefer, ungelocht  
for toothed upper jaws, unperforated  
Maxillaires dentés, non perforés  
para mandíbulas superiores dentadas, no perforadas  
per mascella superiore dentata, non perforata

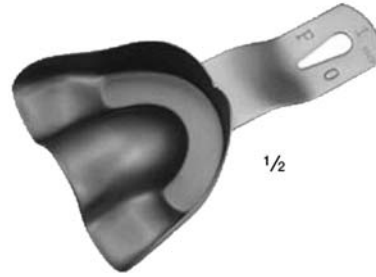

1/2

5121 = Fig. 1  
5122 = Fig. 2

**Form PO (SUP/P)**  
für partiell bezahnte Oberkiefer, ungelocht  
for partially toothed upper jaws, unperforated  
Maxillaires partiellement dentés, non perforés  
para mandíbulas superiores parcialmente dentadas, no perforadas  
per mascella superiore parzialmente dentata, non perforata

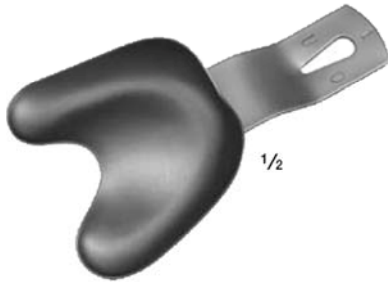

1/2

5131 = Fig. 1  
5132 = Fig. 2

**Form UO (SUP/U)**  
für unbezahnte Oberkiefer, ungelocht  
for edentulous upper jaws, unperforated  
Maxillaires édentés, non perforés  
para mandíbulas desdentadas superiores, no perforadas  
per mascella superiore edentula, non perforata

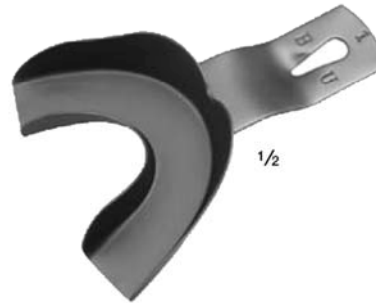

1/2

5151 = Fig. 1  
5152 = Fig. 2  
5153 = Fig. 3  
5154 = Fig. 4

**Form BU (INF/B)**  
für bezahnte Unterkiefer, ungelocht  
for toothed lower jaws, unperforated  
Mandibules dentés, non perforés  
para mandíbulas inferiores dentadas, no perforadas  
per mascella inferiore dentata, non perforata

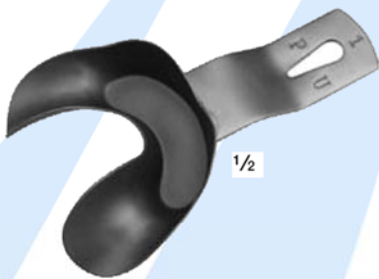

1/2

5161 = Fig. 1  
5162 = Fig. 2

**Form PU (INF/P)**  
für partiell bezahnte Unterkiefer, ungelocht  
for partially toothed lower jaws, unperforated  
Mandibules partiellement dentés, non perforés  
para mandíbulas inferiores parcialmente dentadas, no perforadas  
per mascella inferiore parzialmente dentata, non perforata

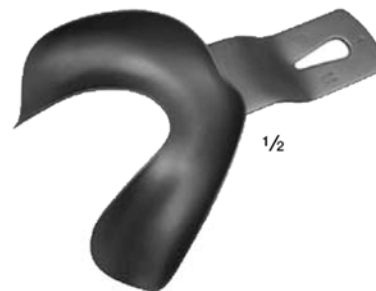

1/2

5171 = Fig. 1  
5172 = Fig. 2

**Form UO (INF/U)**  
für unbezahnte Unterkiefer, ungelocht  
for edentulous lower jaws, unperforated  
Mandibules édentés, non perforés  
para mandíbulas inferiores desdentadas, no perforadas  
per mascella inferiore edentula, non perforata

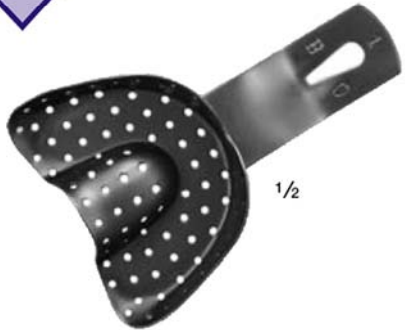

1/2

5201 = Fig. 1  
5202 = Fig. 2  
5203 = Fig. 3  
5204 = Fig. 4

**Form BO (SUP/B)**  
für bezahnte Oberkiefer, gelocht  
for toothed upper jaws, perforated  
Maxillaires dentés, perforés  
para mandibulas superiores detadas, perforadas  
per mascella superiore dentata, perforata

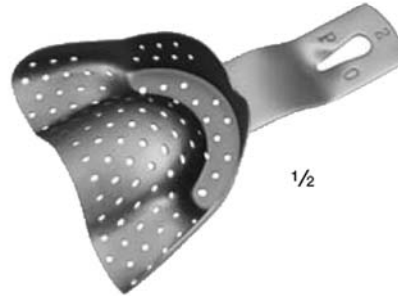

1/2

5221 = Fig. 1  
5222 = Fig. 2

**Form PO (SUP/P)**  
für partiell bezahnte Oberkiefer, gelocht  
for partially toothed upper jaws, perforated  
Maxillaires partiellement dentés, perforés  
para mandibulas superiores parcialmente dentadas, perforadas  
per mascella superiore parzialmente dentata, perforata

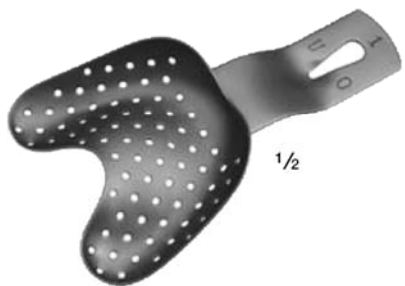

1/2

5231 = Fig. 1  
5232 = Fig. 2  
5233 = Fig. 3

**Form UO (SUP/U)**  
für unbezahnte Oberkiefer, gelocht  
for edentulous upper jaws, perforated  
Maxillaires édentés, perforés  
para mandibulas desdentadas superiores, perforadas  
per mascella superiore edentula, perforata

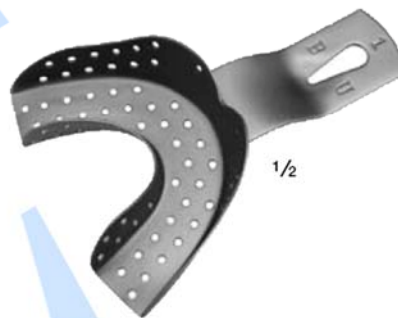

1/2

5251 = Fig. 1  
5252 = Fig. 2  
5253 = Fig. 3  
5254 = Fig. 4

**Form BU (INF/B)**  
für bezahnte Unterkiefer, gelocht  
for toothed lower jaws, perforated  
Mandibules dentés, perforés  
para mandibulas inferiores dentadas, perforadas  
per mascella inferiore dentata, perforata



1/2

5261 = Fig. 1  
5262 = Fig. 2

**Form PU (INF/P)**  
für partiell bezahnte Unterkiefer, gelocht  
for partially toothed lower jaws, perforated  
Mandibules partiellement dentés, perforés  
para mandibulas inferiores parcialmente dentadas, perforadas  
per mascella inferiore parzialmente dentata, perforata

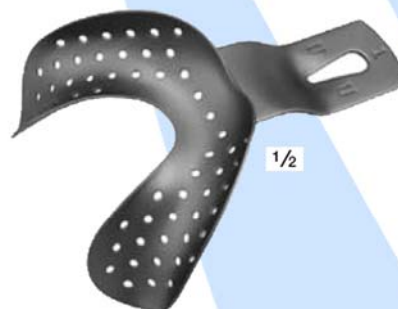

1/2

5271 = Fig. 1  
5272 = Fig. 2  
5273 = Fig. 3

**Form UO (INF/U)**  
für unbezahnte Unterkiefer, gelocht  
for edentulous lower jaws, perforated  
Mandibules édentés, perforés  
para mandibulas inferiores desdentadas, perforadas  
per mascella inferiore edentula, perforata

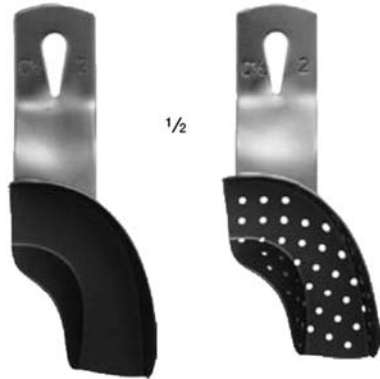

Form C $\frac{1}{2}$ R

ungelocht  
unperforated  
non perforé  
no perforadas  
non perforata

**5702** = Fig. 2

gelocht  
perforated  
perforé  
perforadas  
perforata

**5722** = Fig. 2

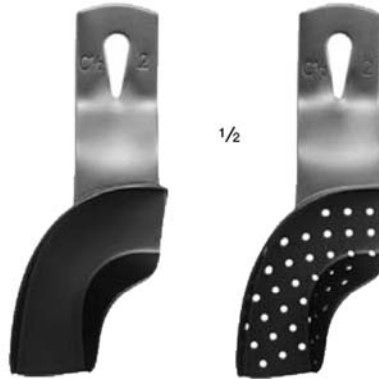

Form C $\frac{1}{2}$ L

ungelocht  
unperforated  
non perforé  
no perforadas  
non perforata

**5712** = Fig. 2

gelocht  
perforated  
perforé  
perforadas  
perforata

**5732** = Fig. 2

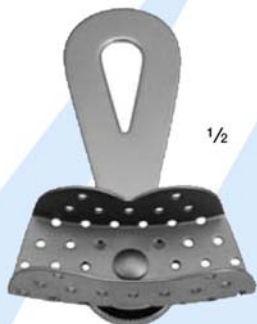

**5751**

mit drehbarem Griff und Stellschraube, gelocht  
with swivel handle and fixing screw, perforated  
avec poignée pivotante et vis de blocage, perforé  
con mango giratorio y tornillo de sujeción, perforadas  
con impugnatura girevole e vite di regolazione, perforata



**5755**

mit drehbarem Griff und Stellschraube, ungelocht  
with swivel handle and fixing screw, unperforated  
avec poignée pivotante et vis de blocage, non perforé  
con mango giratorio y tornillo de sujeción, no perforadas  
con impugnatura girevole e vite di regolazione, non perforata



Stolley  
**5760**

mit drehbarem Griff und Fixierschieber, gelocht  
with swivel handle and slide, perforated  
avec poignée pivotante et curseur de fixation, perforé  
con mango giratorio y cierre corredizo, perforadas  
con impugnatura girevole e cursore di fissaggio, perforata



## Dental



**N 22 T**  
15 cm



**WHO T**  
15 cm



**N 33**  
15 cm

Rundgriff / massiv / gerieft  
Round handle / solid / serrated  
Manche rond / massive / striée  
Mango redando / sólido / estriado  
Manico tondo / solida / zigrinate



**1220/11**  
Whiteside 1  
15,5 cm



**39 R**  
15 cm



**1200/3**  
15 cm



**1200/4**  
15 cm



**1280/2**  
Mitchell  
17 cm



**1200/3 P**  
16 cm



**1280/63 P**  
Rheinwaldhäkchen  
17 cm

Achtkantgriff / massiv / gerieft  
Octagonal handle / solid / serrated  
Manche octogonale / massive / striée  
Mango octagonal / sólido / estriado  
Manico ottagonale / solida / zigrinate

Hohlgriff  
Hollow Handle  
Poignée creuse  
Mango hueco  
Manico cavo

## Dental



## Dental



**204 S Z**  
Universal  
17,5 cm



**CI 2-3 Z**  
16 cm



**N5-U15 Z**  
16 cm



**N 67 Z**  
17 cm



**OR 1-2 Z**  
Urban #1-2  
17 cm

Zahnreiniger  
Scalers  
Instruments à Détartre  
Limpiadores de Sarro  
Ablatori di Tartaro

Neuer LIGHTWEIGHT Griff  
New LIGHTWEIGHT handle  
Neuf manche LIGHTWEIGHT  
Nuevo mango LIGHTWEIGHT  
Nuovo manico LIGHTWEIGHT

Gingivektomiemesser  
Gingivectomy knives  
Bistouris pour la gingivectomie  
Bisturios para la gingivectomia  
Bisturie per gingivectomia

Neuer LIGHTWEIGHT Griff  
New LIGHTWEIGHT handle  
Neuf manche LIGHTWEIGHT  
Nuevo mango LIGHTWEIGHT  
Nuovo manico LIGHTWEIGHT





**GR 1-2 Z**

Gracey  
#1-2  
17,5 cm

Frontzähne, universell  
Incisors universal  
Incisives, universal  
Incisivos universal  
Incisivi, universali

Neuer LIGHTWEIGHT Griff  
New LIGHTWEIGHT handle  
Neuf manche LIGHTWEIGHT  
Nuevo mango LIGHTWEIGHT  
Nuovo manico LIGHTWEIGHT



**GR 3-4 Z**

Gracey  
#3-4  
17 cm

Frontzähne, Prämolaren universell  
Incisors, premolars universal  
Incisives, prémolaires universel  
Incisivos, prémolares universal  
Incisivi, premolari universali

Neuer LIGHTWEIGHT Griff  
New LIGHTWEIGHT handle  
Neuf manche LIGHTWEIGHT  
Nuevo mango LIGHTWEIGHT  
Nuovo manico LIGHTWEIGHT



**GR 5-6 Z**

Gracey  
#5-6  
17,5 cm

Frontzähne, Prämolaren universell  
Incisors, premolars universal  
Incisives, prémolaires universel  
Incisivos, prémolares universal  
Incisivi, premolari universali

Neuer LIGHTWEIGHT Griff  
New LIGHTWEIGHT handle  
Neuf manche LIGHTWEIGHT  
Nuevo mango LIGHTWEIGHT  
Nuovo manico LIGHTWEIGHT



**GR 7-8 Z**

Gracey  
#7-8  
17,5 cm

Prämolaren, Molaren, lingual / bukkal  
Premolars, molars, lingual / buccal  
Prémolaires, molaires lingual, buccal  
Premolares, molares, lingual / bucal  
Premolari, molari, linguale / buccali

Neuer LIGHTWEIGHT Griff  
New LIGHTWEIGHT handle  
Neuf manche LIGHTWEIGHT  
Nuevo mango LIGHTWEIGHT  
Nuovo manico LIGHTWEIGHT



**Dental**



**586 WS**  
Witzel  
14,5 cm

untere Wurzeln  
lower roots  
racines inférieures  
raíces inferiores  
radici inferiori

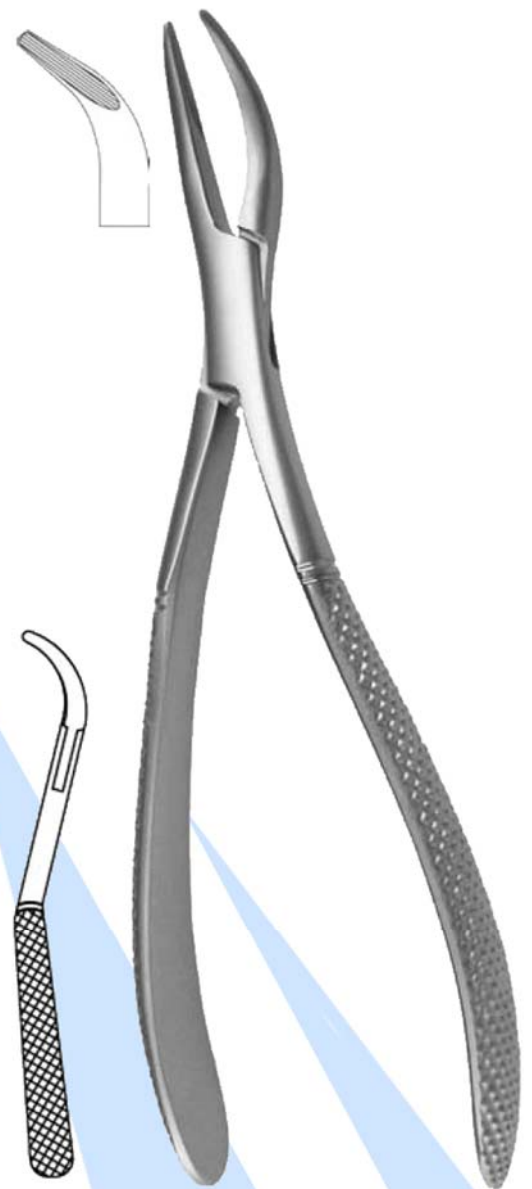

**588 WS**  
Witzel  
14,5 cm

obere Wurzeln  
upper roots  
racines supérieures  
raíces superiores  
radici superiori

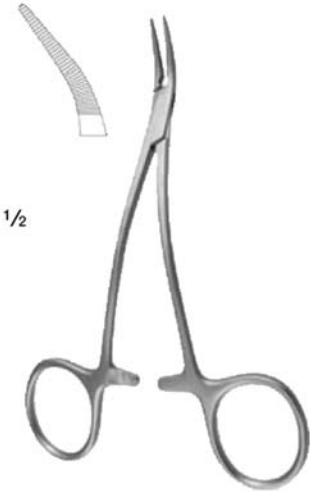

1/2

**597**  
Peet  
12 cm

Wurzelfragmente  
Root fragments  
Fragments de racines  
Fragmentos de raices  
Frammenti

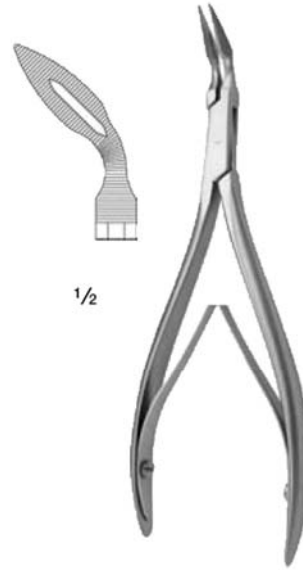

1/2

**596/1**  
Ralk  
14 cm

Wurzelfragmente  
Root fragments  
Fragments de racines  
Fragmentos de raices  
Frammenti

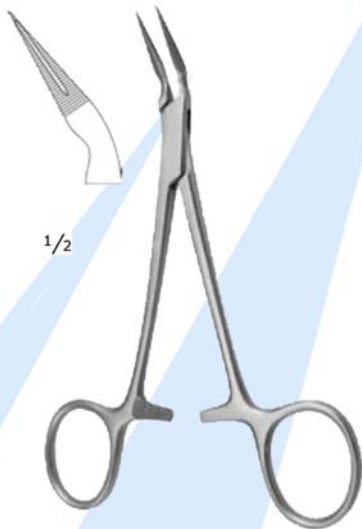

1/2

**592**  
Stieglitz  
13,5 cm

Wurzelfragmente  
Root fragments  
Fragments de racines  
Fragmentos de raices  
Frammenti

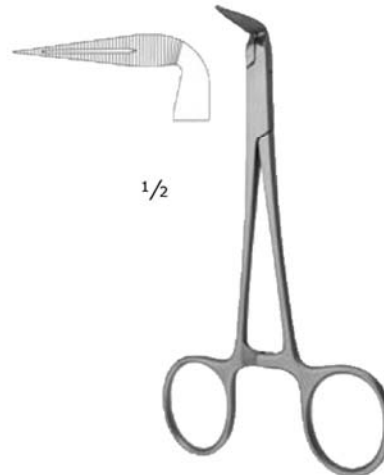

1/2

**593**  
Stieglitz  
12 cm

Wurzelfragmente  
Root fragments  
Fragments de racines  
Fragmentos de raices  
Frammenti



**MULTICRAFTS** Corporation

**Dental**



**2520/2**  
15 cm

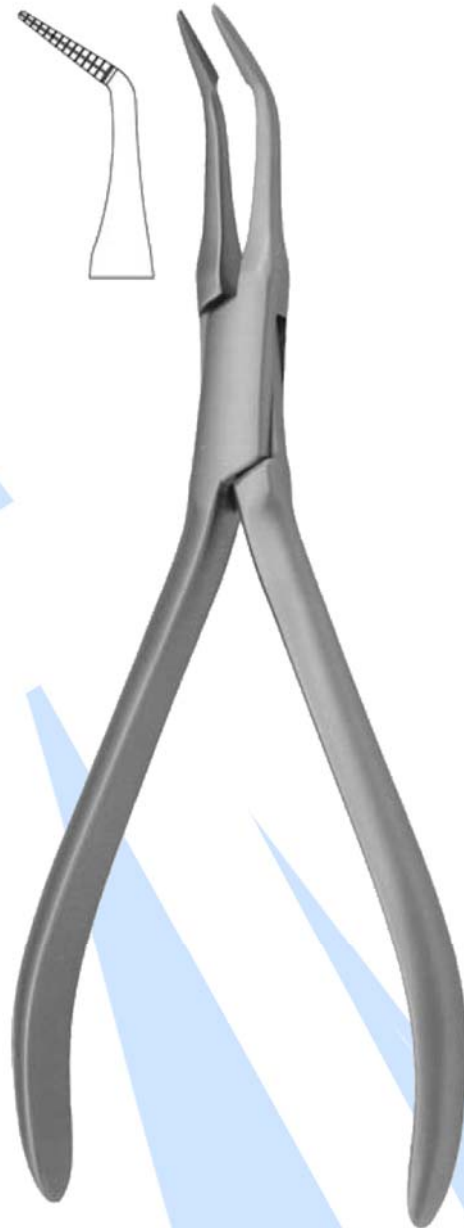

**2520/5**  
15 cm

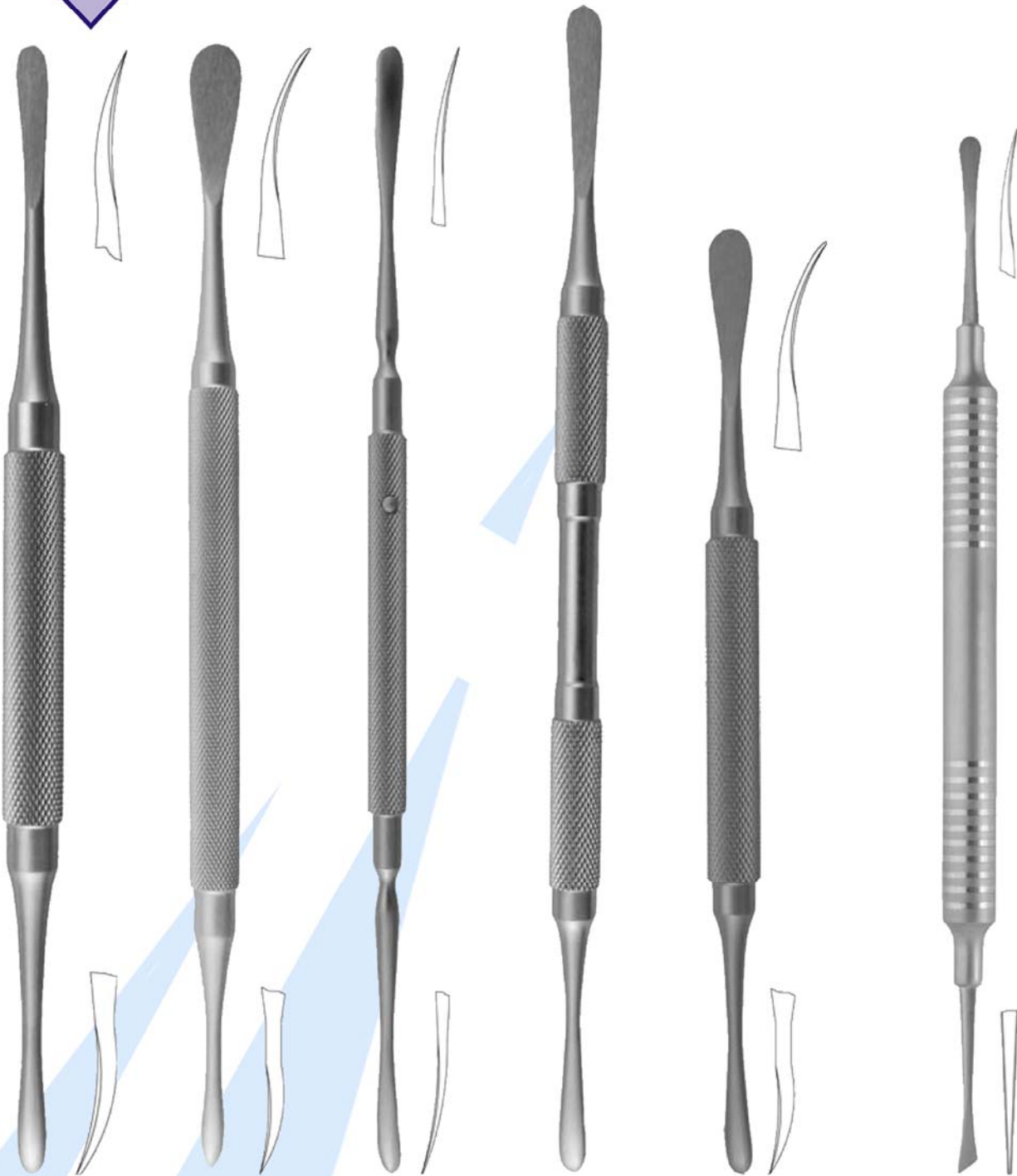

**885/3**  
Molt  
18,5 cm

**885/5**  
Molt # 9  
18,5 cm

**890/1**  
Freer  
18,5 cm

**902/41**  
19 cm

**I/6**  
Implantologie  
15,5 cm

**O 24 GZ**  
17 cm

Rundgriff / massiv / gerieft  
Round handle / solid / serrated  
Manche rond / massive / striée  
Mango redando / sólido / estriado  
Manico tondo / solida / zigrinate

Neuer LIGHTWEIGHT Griff  
New LIGHTWEIGHT handle  
Neuf manche LIGHTWEIGHT  
Nuevo mango LIGHTWEIGHT  
Nuovo manico LIGHTWEIGHT

## Dental



## Dental



**901/84**  
# 856  
18 cm



**901/85**  
# 854  
18,5 cm



**901/86**  
# 853  
18 cm



**901/89**  
Bennet # 12 S  
18 cm



**901/97**  
Albjerg  
17,5 cm



**901/98**  
Alley  
21 cm

Rundgriff / massiv  
Round handle / solid  
Manche rond / massive  
Mango redando / sólido  
Manico tondo / solida



**888/23**

18 cm



**888/3**

Cleve-Dent  
19 cm



**888/4**

18 cm



**888/94**

Molt  
19 cm



**888/3A**

# 9 H  
17,5 cm

Achtkantgriff / massiv / gerieft  
Octagonal handle / solid / serrated  
Manche octogonale / massive / striée  
Mango octagonal / sólido / estriado  
Manico ottagonale / solida / zigrinate

## Dental



Dental



PA 19  
16 cm



880/1  
Williger  
16 cm

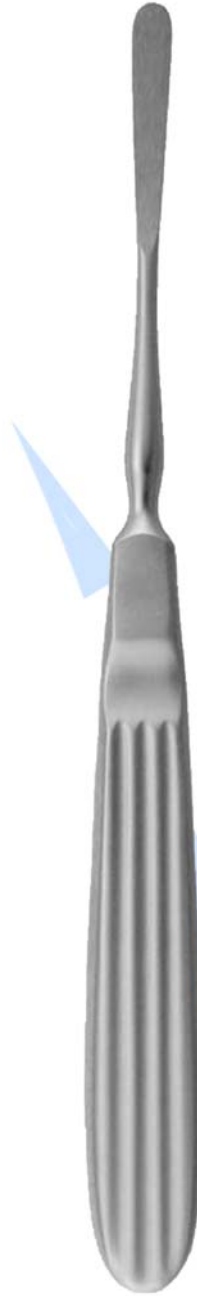

910/5  
Tessier  
18 cm

Hohlgriff  
Hollow handle  
Poignée creuse  
Mango hueco  
Manico cavo



910/7  
Tessier  
18 cm

Hohlgriff  
Hollow handle  
Poignée creuse  
Mango hueco  
Manico cavo



910/9  
Tessier  
18 cm

Hohlgriff  
Hollow handle  
Poignée creuse  
Mango hueco  
Manico cavo





# MULTICRAFTS Corporation



**901/24**  
Miller-Colburn  
# 9  
18 cm

**901/25**  
Miller-Colburn  
# 10  
19 cm

**901/26**  
Miller-Colburn  
# 11  
19 cm

**901/27**  
Miller-Colburn  
# 12  
19 cm

**901/28**  
Miller-Colburn  
# 13  
18,5 cm

**901/35**  
Molt  
18,5 cm

**901/309**  
Terry  
18,5 cm

Rundgriff / massiv  
Round handle / solid  
Manche rond / massive  
Mango redando / sólido  
Manico tondo / solida

## Dental



## Dental

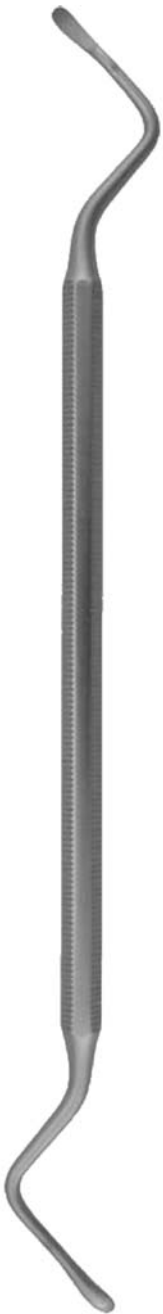

**920-11**  
Lucas  
# 1 R - 1 L  
18 cm



**920-22**  
Lucas  
# 2 R - 2 L  
18 cm



**920-33**  
Lucas  
# 3 R - 3 L  
18 cm



**920-44**  
Lucas  
# 4 R - 4 L  
18 cm



**920-85**  
Lucas  
17 cm

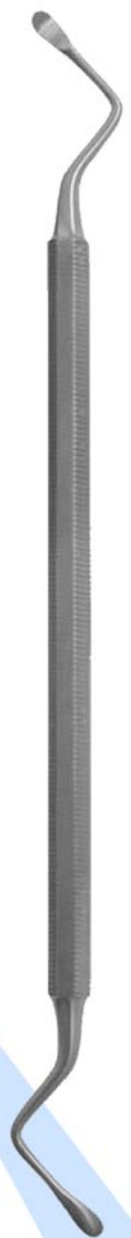

**920-86**  
Lucas  
17 cm

Achtkantgriff / massiv / gerieft  
Octagonal handle / solid / serrated  
Manche octogonale / massive / striée  
Mango octagonal / sólido / estriado  
Manico ottagonale / solida / zigrinate



# MULTICRAFTS Corporation



**925/7**  
18 cm



**925/8**  
18 cm



**925/9**  
18 cm



**928/1**  
18,5 cm



**928/2**  
19 cm



**928/3**  
19 cm

Achtkantgriff / massiv / gerieft  
Octagonal handle / solid / serrated  
Manche octagonal / massive / striée  
Mango octagonal / sólido / estriado  
Manico ottagonale / solida / zigrinate

Rundgriff / massiv / gerieft  
Round handle / solid / serrated  
Manche rond / massive / striée  
Mango redondo / sólido / estriado  
Manico tondo / solida / zigrinate

## Dental



## Dental



**926/30**  
Molt #5 L  
18 cm

Hohlgriff  
Hollow handle  
Poignée creuse  
Mango hueco  
Manico cavo



**926/31**  
Molt #5 R  
18 cm

Hohlgriff  
Hollow handle  
Poignée creuse  
Mango hueco  
Manico cavo



**926/32**  
Molt #4  
16,5 cm

Hohlgriff  
Hollow handle  
Poignée creuse  
Mango hueco  
Manico cavo



**926/33**  
Molt #2  
17 cm

Hohlgriff  
Hollow handle  
Poignée creuse  
Mango hueco  
Manico cavo



**926/34**  
Molt #1  
17 cm

Hohlgriff  
Hollow handle  
Poignée creuse  
Mango hueco  
Manico cavo



**930/0**  
Hemingway  
2,6 / 2,6 mm  
16,5 cm



**930/4**  
Hemingway  
2,8 / 2,8 mm  
16,5 cm



**930/5**  
Hemingway  
3,2 / 3,2 mm  
16,5 cm



**930/6**  
Hemingway  
3,8 / 3,8 mm  
16,5 cm

Achtkantgriff / massiv / gerieft  
Octagonal handle / solid / serrated  
Manche octagonal / massive / striée  
Mango octagonal / sólido / estriado  
Manico ottagonale / solida / zigrinate

## Dental



## Dental



**932/9 R**  
2,7 / 2,7 mm  
17 cm



**932/9 AR**  
2,7 / 2,7 mm  
17 cm



**932/10 R**  
3,2 / 3,2 mm  
17 cm



**932/10 AR**  
3,2 / 3,2 mm  
17 cm



**932/11 R**  
3,8 / 3,8 mm  
17 cm



**932/11 AR**  
3,8 / 3,8 mm  
17 cm

Rundgriff / massiv / gerieft  
Round handle / solid / serrated  
Manche rond / massive / striée  
Mango redando / sólido / estriado  
Manico tondo / solida / zigrinate



# MULTICRAFTS Corporation

# Dental



**966**  
Mueller  
8 cm

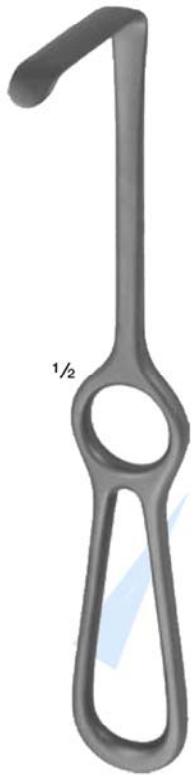

**968/1**  
56 x 11 mm  
Kocher  
20,5 cm

**968/2**  
40 x 11 mm  
Kocher  
20,5 cm

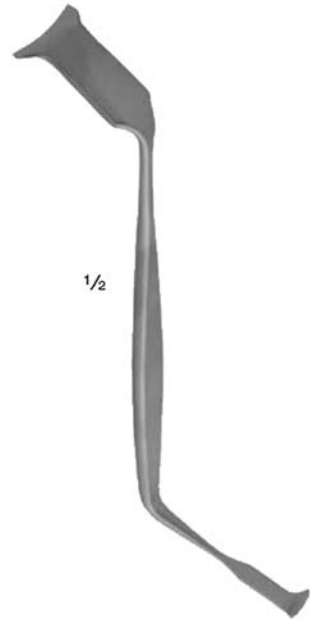

**980/5**  
16,5 cm

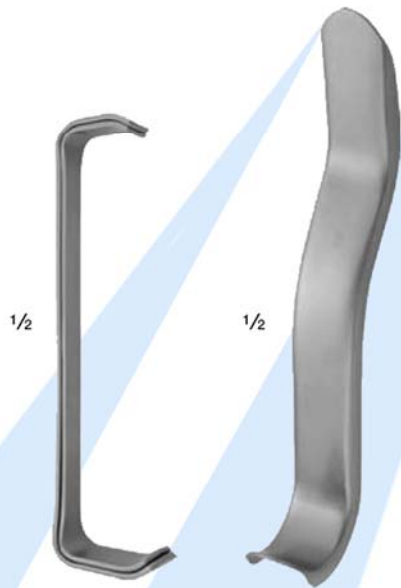

**998/13**  
Farabeuf  
12,5 cm

**998/20**  
University of Minnesota  
15,5 cm

Zungendrucker  
Tongue depressor  
Abaisse-langue  
Depresor de lengua  
Abbassalingua



**999/21**  
Wieder  
14 cm



**999/22**  
Wieder  
16 cm

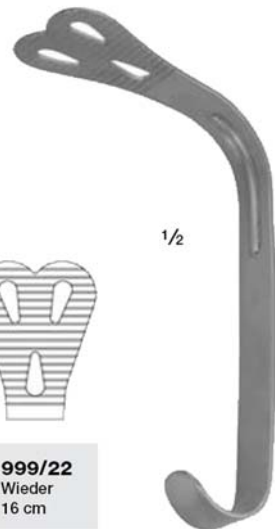



## Dental

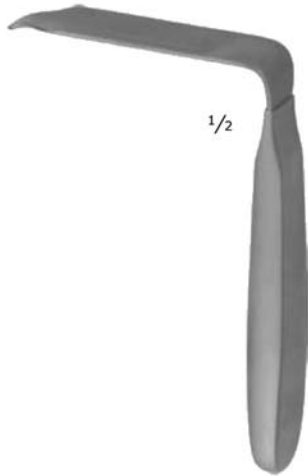

1/2

**999/1**  
Austin  
13 cm

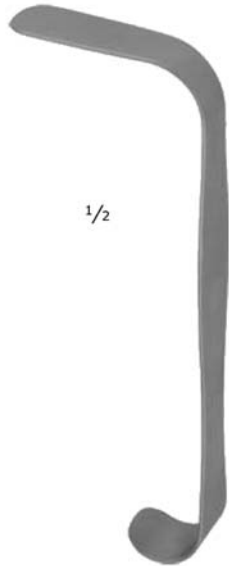

1/2

**999/4**  
Catania  
15,5 cm

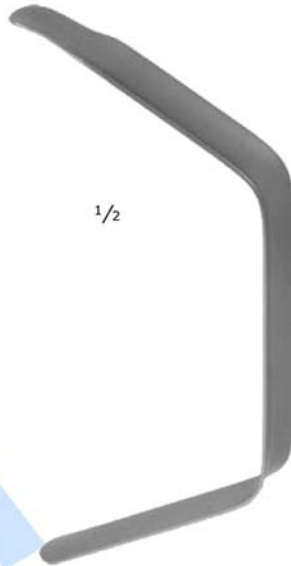

1/2

**999/5**  
Ronnau  
15,5 cm

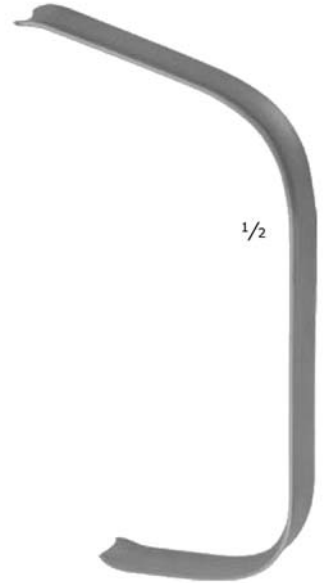

1/2

**999/6**  
16 cm



1/2

**999/3**  
Austin  
#2  
8 cm



1/2

**999/3 B**  
8,5 cm

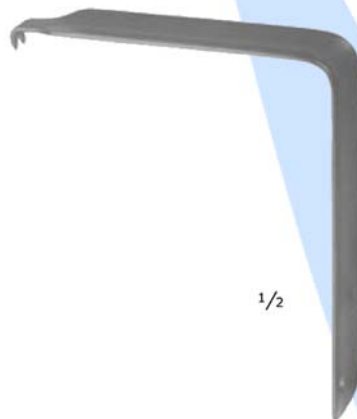

1/2

**999/97**  
Austin  
#3  
11,5 cm





Rundgriff / massiv  
 Round handle / solid  
 Manche rond / massive  
 Mango redondo / sólido  
 Manico tondo / solida

**901/78**  
 Henahan  
 # 1 - 2  
 21 cm

**901/79**  
 Henahan  
 # 1 - 3  
 21 cm

**901/80**  
 Henahan  
 # 2 - 3  
 21 cm



**926/84**  
 Henahan  
 # 1  
 17,5 cm

**926/85**  
 Henahan  
 # 2  
 18 cm

**926/86**  
 Henahan  
 # 3  
 18,5 cm

Hohlgriff  
 Hollow handle  
 Poignée creuse  
 Mango hueco  
 Manico cavo

Hohlgriff  
 Hollow handle  
 Poignée creuse  
 Mango hueco  
 Manico cavo

Hohlgriff  
 Hollow handle  
 Poignée creuse  
 Mango hueco  
 Manico cavo

## Dental

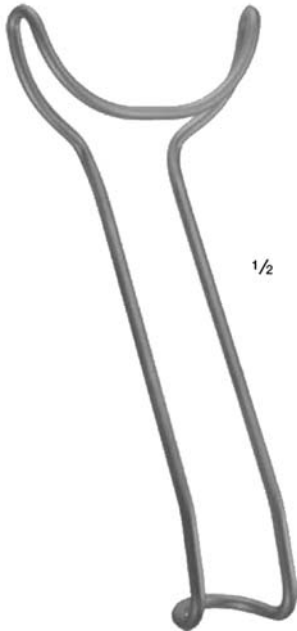

**967/1**  
18 cm

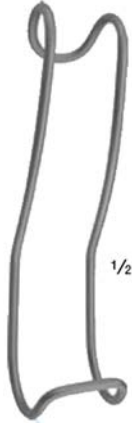

**1005/12**  
Sternberg  
12 cm

**1005/14**  
Sternberg  
14 cm

**1005/16**  
Sternberg  
16 cm



**1115/11**  
Molt  
11 cm

**1115**  
for 1115/11 &  
1115/14

1 Paar Schutzhüllen  
1 pair of protective covers  
1 paire enveloppe protectrice  
1 pareja cubierta protectora  
1 coppia custodia

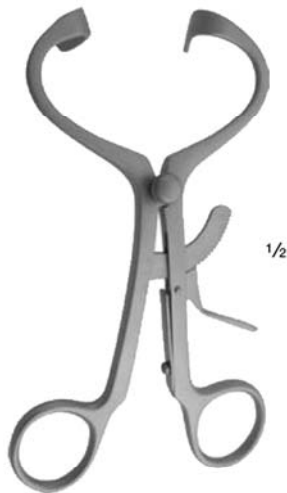

**1115/14**  
Molt  
14 cm

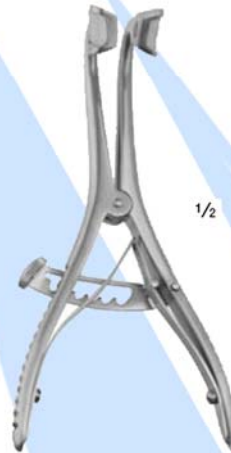

**1122**  
Denhart  
13 cm

**1122 E**  
for 1122

1 Paar Silikoneinlage  
1 pair of silicon inserts  
1 paire de protecteurs silicones  
1 pareja de silicón capas  
1 coppia di inserti del silicone



**2320/2**  
London-College  
15 cm

gerieft, mit Sperre  
serrated, with lock  
striée, avec cierre  
estriada, con cierre  
zigrinata, con fermo



**2325/1**  
London-College  
15 cm

für Silberspitzen, mit Sperre  
for silver points, with lock  
pour cones d'argent, avec cierre  
para puntas de plata, con cierre  
per punte d'argento, con fermo



**2325/2**  
London-College  
15 cm

für Silberspitzen, mit Sperre  
for silver points, with lock  
pour cones d'argent, avec cierre  
para puntas de plata, con cierre  
per punte d'argento, con fermo



**2265 D**  
Meriam  
16 cm



diamantierte Spitzen  
diamonded tips  
pointes diamantées  
puntas diamantadas  
punte diamantate

## Dental



## Dental



**2379**

13,5 cm

Hohlgriff  
Hollow handle  
Poignée creuse  
Mango hueco  
Manico cavo



**2379-3**

# 1

o 3,0 mm

4,5 cm

**2379-5**

# 2

o 5,0 mm

4,5 cm

**2379-6**

# 3

□ 3 x 6 mm

4,5 cm

Rhodium-Mikrospiegelansatz in rodio für höchste Ansprüche unterm Mikroskop  
Rhodium- micro mirror for highest requirements under the microscope  
Micro-miroir au rhodium pour des exigences extremes sous le microscope  
Microespejo de rodio para las más altas exigencias bajo el microscopio  
Microspecchio metallico per i massimi requisiti al microscopio

für Wurzelspitzenresektion, passend für jeden Spiegelgriff, metr. Gewinde  
for apicoectomy, suitable for any mirror handle, metr. thread  
pour, résection de l'apex de la racine, adapté à chaque poignée de miroir, filetage métrique  
para la apicectomia, apropiado para cualquier mango de espejo, rosca métrica  
per apicectomia, appropriato a ogni tipo di impugnatura di specchio, filettatura metrica



**MULTICRAFTS** Corporation



**611**  
14 cm



**611 F**  
14 cm



**611 S**  
14 cm

**Dental**



## Dental

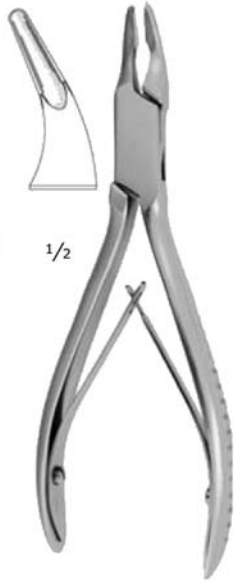

**825/1**  
Blumenthal  
15,5 cm

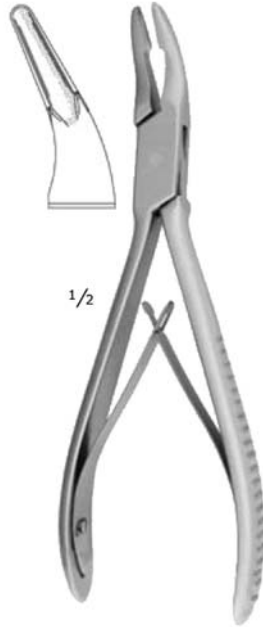

**825/8**  
Mead 1 A  
16,5 cm

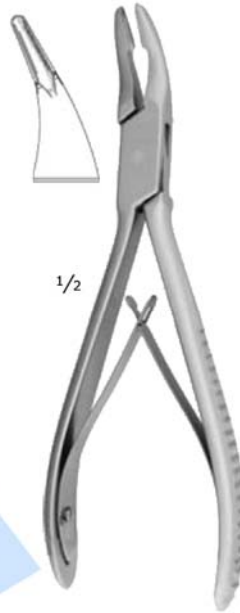

**825/8 S**  
16,5 cm

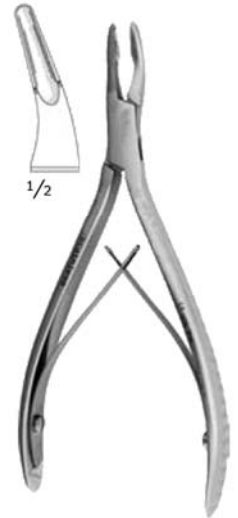

**825/10**  
Friedman  
13,5 cm

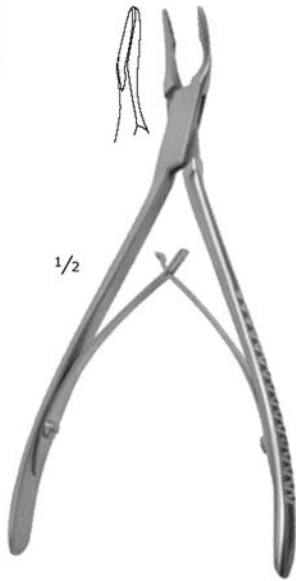

**825/10 M**  
Micro-Friedman  
15,5 cm

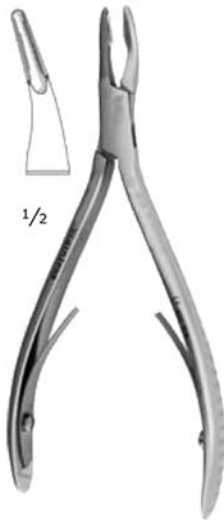

**825/10 S**  
Friedman-Vickers  
14 cm

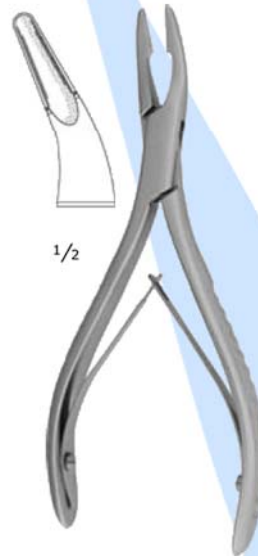

**825/11**  
Luer  
15 cm

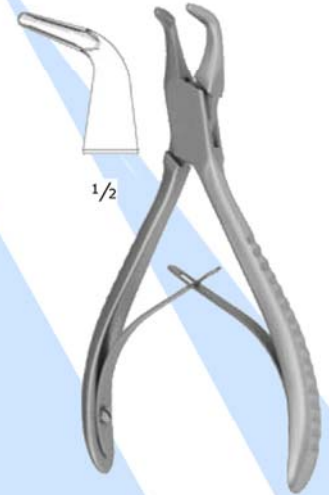

**825/20**  
13,5 cm



# MULTICRAFTS Corporation

# Dental



**830/404**  
4 mm  
17 cm



**830/405**  
4 mm  
17,5 cm

Rundgriff / massiv  
Round handle / solid  
Manche rond / massive  
Mango redando / sólido  
Manico tondo / solida



**831/399**  
Stout #1  
3 mm  
21,5 cm



**831/400**  
Stout #2  
4 mm  
21 cm



**831/401**  
Stout #3  
5 mm  
22 cm



**850/402**  
4 mm  
18 cm

Achtkantgriff / massiv / gerieft  
Octagonal handle / solid / serrated  
Manche octagonal / massive / striée  
Mango octagonal / sólido / estriado  
Manico ottagonale / solida / zigrinate



# MULTICRAFTS Corporation

## Dental



1/2

**860/2**  
140 g  
16,5 cm

bleigefüllt  
lead filled  
rempli de plomb  
releno de plomo  
interno piombo

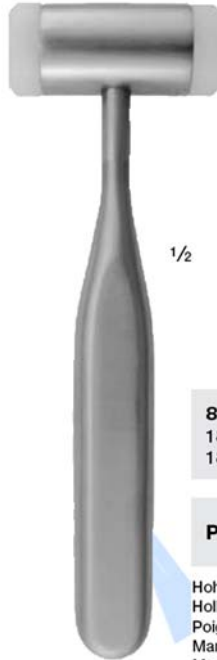

1/2

**860/5**  
180 g  
18 cm

**PE 860/5**

Hohlgriff / auswechselbare Kunststoffeinsätze Art No. PE 860 / 5  
Hollow handle / interchangeable plastic inserts Art No. PE 860 / 5  
Poignée creuse / plaques interchangeable en matériel plastique Art No. PE 860 / 5  
Mango hueco / tapas de plástico intercambiables Art No. PE 860 / 5  
Manico cavo / inserti plastica intercambiabili Art No. PE 860 / 5



1/2

**860/4**  
Mead  
19 cm  
320 g

**860/4E**

Auswechselbare Kunststoffeinsätze Art No. 860 / 4 E  
Interchangeable plastic inserts Art No. 860 / 4 E  
Plaques interchangeable en matériel plastique Art No. 860 / 4 E  
Tapas de plástico intercambiables Art No. 860 / 4 E  
Inserti plastica intercambiabili Art No. 860 / 4 E



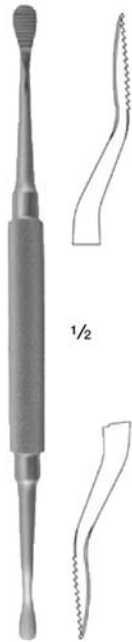

**865 / 201**  
Howard  
# 12  
18,5 cm

Rundgriff / massiv / gerieft  
Round handle / solid / serrated  
Manche rond / massive / striée  
Mango redondo / sólido / estriado  
Manico tondo / solida / zigrinate

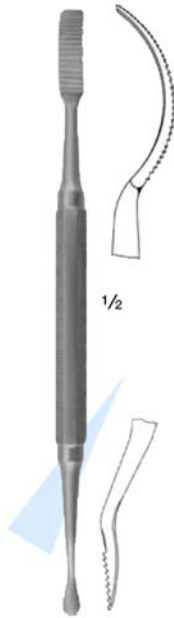

**875 / 3**  
Miller-Colburn  
#3  
17,5 cm

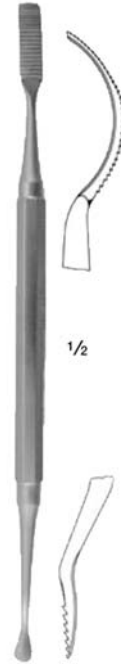

**875/29**  
Miller  
#52  
19 cm

Achtkantgriff / massiv / gerieft  
Octagonal handle / solid / serrated  
Manche octagonal / massive / striée  
Mango octagonal / sólido / estriado  
Manico ottagonale / solida / zigrinate

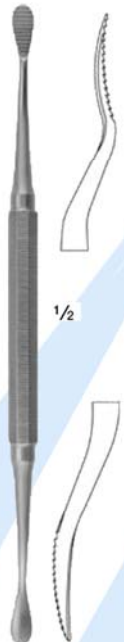

**875/1**  
18,5 cm



**875 / 12**  
Miller-Colburn #1  
17 cm

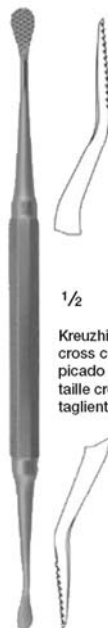

**875/2 K**  
18 cm

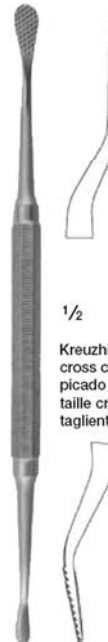

**875/8**  
Miller-Colburn #1  
18,5 cm

Achtkantgriff / massiv / gerieft  
Octagonal handle / solid / serrated  
Manche octagonal / massive / striée  
Mango octagonal / sólido / estriado  
Manico ottagonale / solida / zigrinate



# MULTICRAFTS Corporation

## Dental

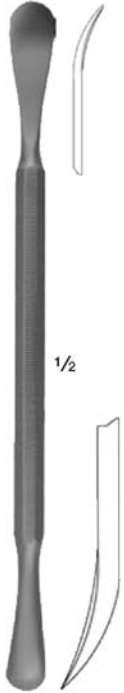

**898/23**  
Seldin  
19 cm

Achtkantgriff / massiv / gerieft  
Octagonal handle / solid / serrated  
Manche octagonal / massive / striée  
Mango octagonal / sólido / estriado  
Manico ottagonale / solida / zigrinate

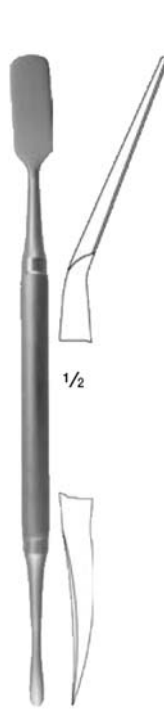

**880/6 B**  
18 cm

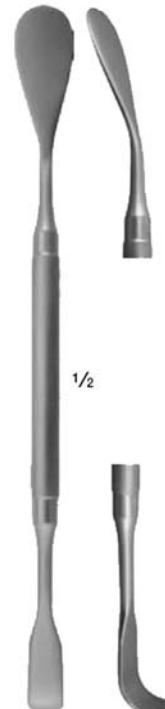

**890 / 11**  
Orbita-Haken  
19,5 cm

Rundgriff / massiv  
Round handle / solid  
Manche rond / massive  
Mango redondo / sólido  
Manico tondo / solida

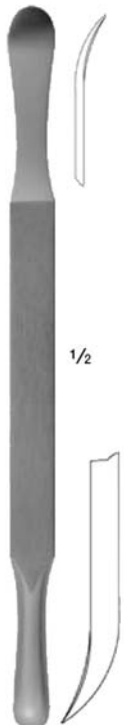

**895/23**  
Seldin  
20 cm

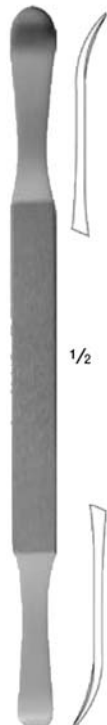

**895/23 D**  
Seldin  
20 cm

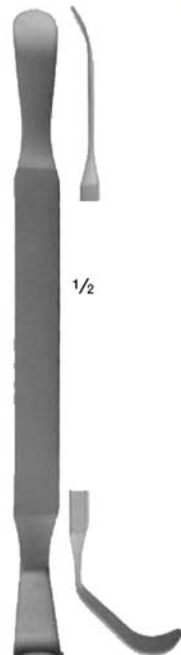

**895/26**  
18 cm

massiv  
solid  
massive  
sólido  
solida

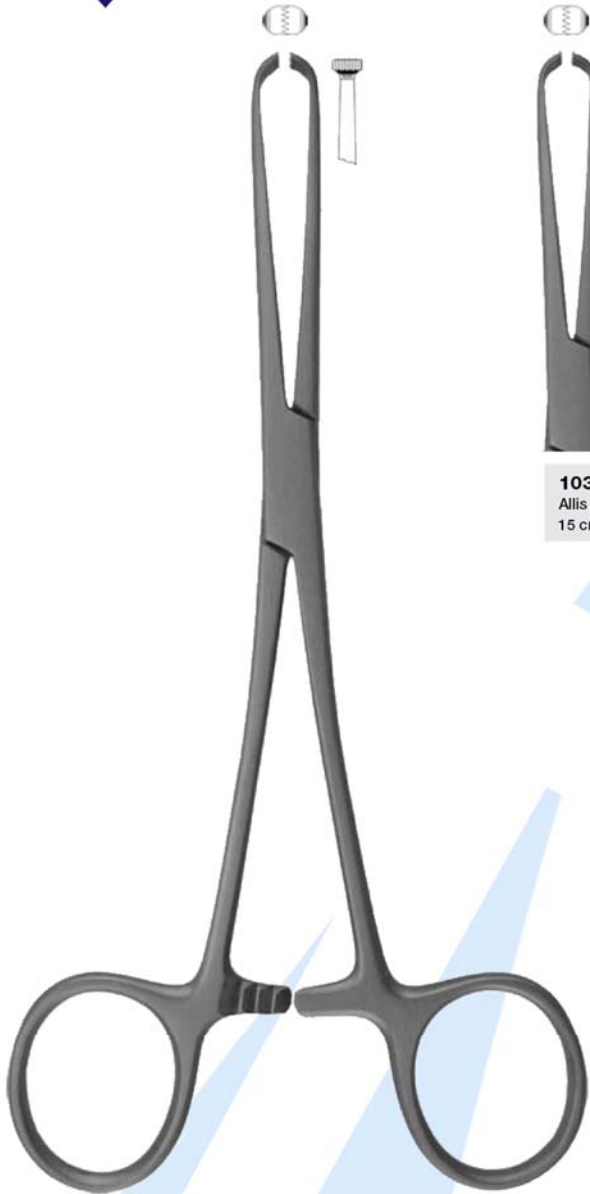

**1030/1**  
Allis  
16 cm

Zahnfleischfzszangen  
Gum seizing forceps  
Pince à gencive  
Pinze para filar la enclá  
Pinze per gengive



**1030/2**  
Allis  
15 cm



**1030/3**  
Allis  
15 cm

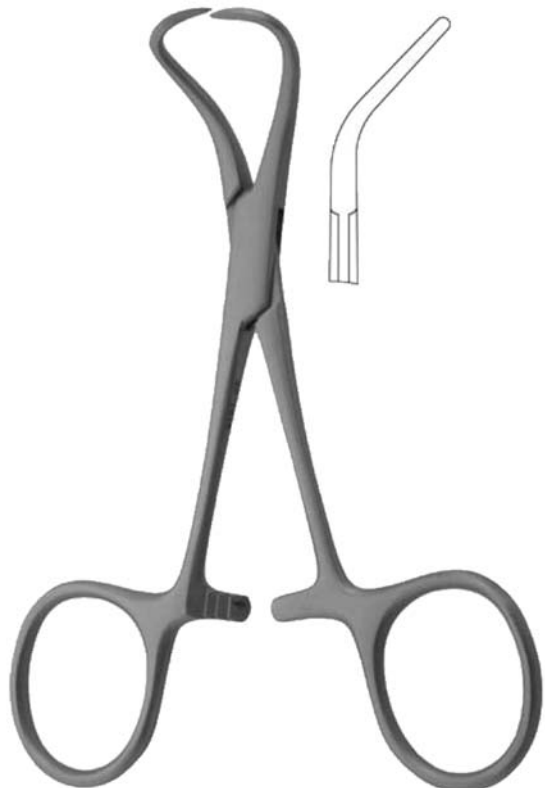

**1065**  
Backhaus  
11 cm

Tuchklemme  
Towel clip  
Pince à champs  
Pinza de campo  
Pinze per pannolino

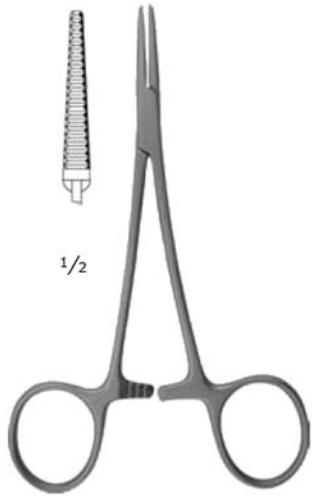

**1050/1**  
Halstead-  
Mosquito  
12,5 cm



**1050/2**  
Halstead-  
Mosquito  
12,5 cm

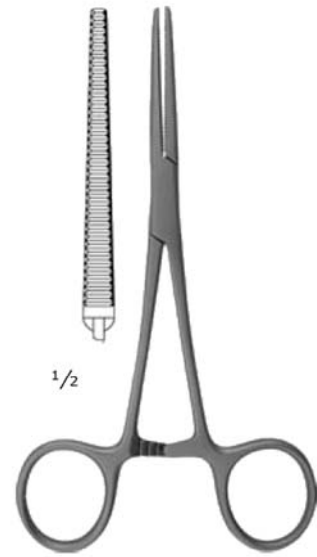

**1055/1**  
Pean  
14 cm



**1055/2**  
Pean  
14 cm

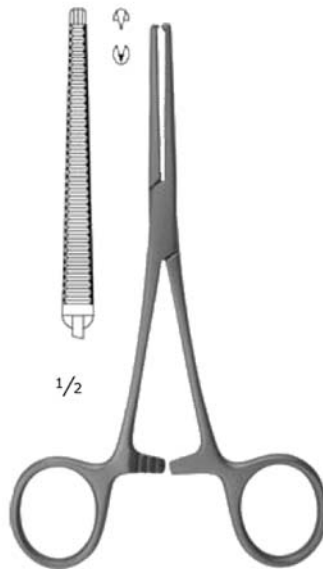

**1060/1**  
Kocher  
14 cm



**1060/2**  
Kocher  
14 cm

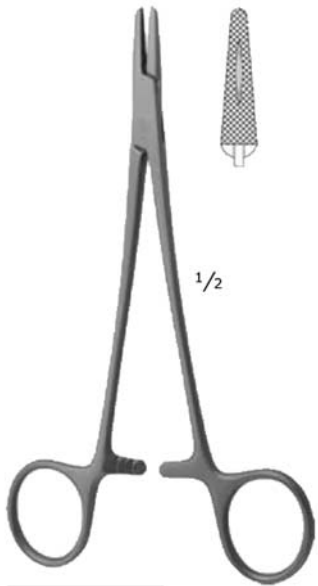

**1070/15**  
Mayo-Hegar  
15 cm

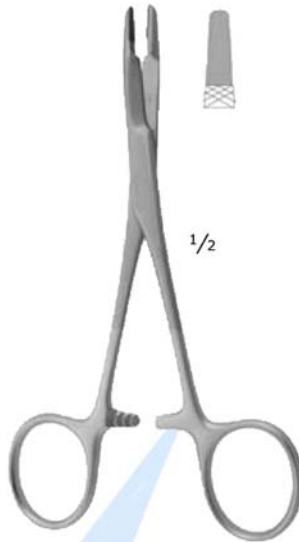

**1084/14 TC**  
Olsen-Hegar  
14 cm

TC =  
Hartmetalleinsätze  
Tungsten carbide inserts  
Pointes en tungstène  
Puntas de tungsteno  
Punte al carburo di tungsteno

**1084/17 TC**  
Olsen-Hegar  
17 cm

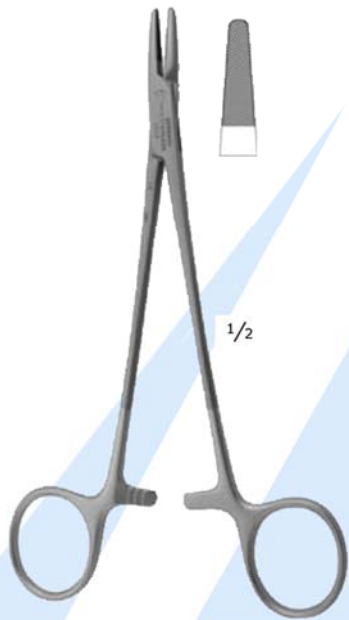

**1097 TC**  
Mayo-Hegar  
16 cm

TC =  
Hartmetalleinsätze  
Tungsten carbide inserts  
Pointes en tungstène  
Puntas de tungsteno  
Punte al carburo di tungsteno

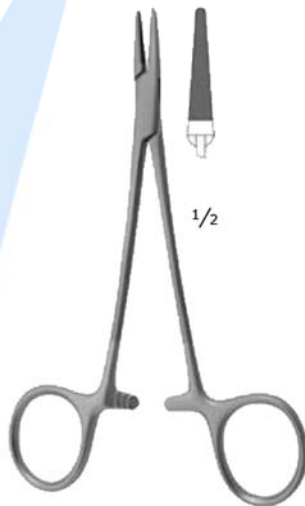

**1099/13 TC**  
Halsey  
13 cm

TC =  
Hartmetalleinsätze  
Tungsten carbide inserts  
Pointes en tungstène  
Puntas de tungsteno  
Punte al carburo di tungsteno

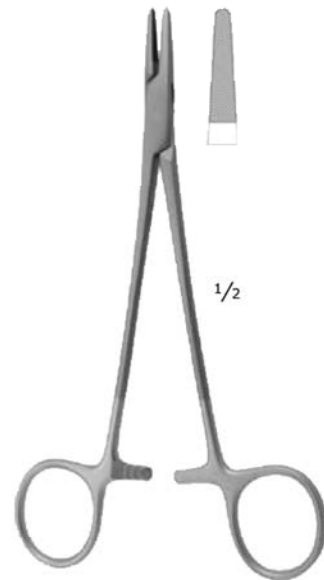

**1099/15 TC**  
Crile-Wood  
15 cm

TC =  
Hartmetalleinsätze  
Tungsten carbide inserts  
Pointes en tungstène  
Puntas de tungsteno  
Punte al carburo di tungsteno

**1099/18 TC**  
Crile-Wood  
18 cm



# MULTICRAFTS Corporation

## Dental



**1076/14**  
Mathieu  
14 cm

**1076/17**  
Mathieu  
17 cm



**1093/14 TC**  
Mathieu  
14 cm

**1093/17 TC**  
Mathieu  
17 cm

TC =  
Hartmetalleinsätze  
Tungsten carbide inserts  
Pointes en tungstène  
Puntas de tungsteno  
Punte al carburo di tungsteno

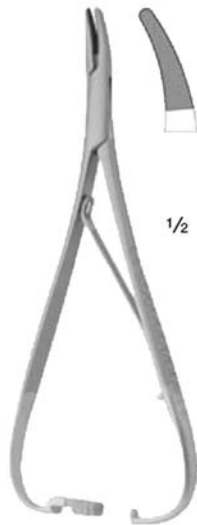

**1094/14 TC**  
Mathieu-Metzenbaum  
14 cm

**1094/17 TC**  
Mathieu-Metzenbaum  
17 cm

TC =  
Hartmetalleinsätze  
Tungsten carbide inserts  
Pointes en tungstène  
Puntas de tungsteno  
Punte al carburo di tungsteno

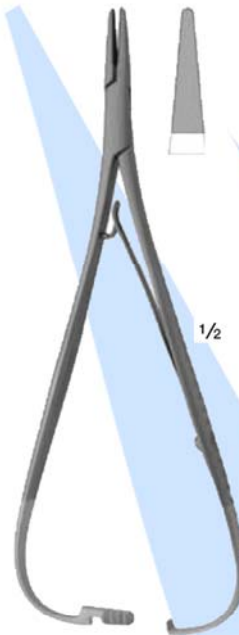

**1098 TC**  
Lichtenberg  
17 cm

**1098 1 TC**  
Lichtenberg  
17 cm

TC =  
Hartmetalleinsätze  
Tungsten carbide inserts  
Pointes en tungstène  
Puntas de tungsteno  
Punte al carburo di tungsteno

gebogen  
curved  
courbées  
curvas  
curve



**1096 TC**

Castroviejo  
14 cm

**1096/1 TC**

Castroviejo  
18 cm

TC =  
Hartmetalleinsätze  
Tungsten carbide inserts  
Pointes en tungstène  
Puntas de tungsteno  
Punte al carburo di tungsteno



**1096/2 TC**

Castroviejo  
14 cm

**1096/3 TC**

Castroviejo  
18 cm

TC =  
Hartmetalleinsätze  
Tungsten carbide inserts  
Pointes en tungstène  
Puntas de tungsteno  
Punte al carburo di tungsteno



**1096/5 TC**

Barraquer  
14 cm

**1096/6 TC**

Barraquer  
18 cm

TC =  
Hartmetalleinsätze  
Tungsten carbide inserts  
Pointes en tungstène  
Puntas de tungsteno  
Punte al carburo di tungsteno



# MULTICRAFTS Corporation

## Dental



**1145/110**  
4,1 cm



**1145/111**  
4,3 cm



**1145/112**  
3,8 cm



**1145/113**  
4,2 cm



**1145/115**  
4 cm

Skalpellklingen / steril  
Scalpel blades / sterile  
Lames de bistouris / stérile  
Hojas de bisturios / estériles  
Lame per bisturi / sterili

einzel verpackt / Packung mit 100 Stück  
single packed / package with 100 units  
enveloppe individuelle / boîte de 100 lames  
envase individual / paquete con 100 unidades  
bustina individuale / scatola di 100 lame



**1145/3**  
#3  
13 cm



**1151/1 A**  
14,5 cm



**1145/7**  
#7  
16 cm



**1151/1**  
16 cm



**1151/2**  
16 cm

abgewinkelt  
angled  
anglé  
acodadas  
angolato



**1152**  
Screwable  
15,5 cm





# MULTICRAFTS Corporation



**1145/64**  
3 cm

**1145/65**  
3,2 cm

**1145/67**  
3,2 cm

**1145/69**  
3 cm

Mikro-Skalpellklingen / steril  
Micro scalpel blades / sterile  
Micro lames de bistouris / stériles  
Micro hojas de bisturios / estériles  
Micro lame per bisturi / sterili

einzelner verpackt / Packung mit 10 Stück  
single packed / package with 10 units  
enveloppe individuelle / boîte de 10 lames  
envase individual / paquete con 10 unidades  
bustina individuale / scatola di 10 lame

beidseitig schneidend  
two cutting edges  
tranchant de deux côtés  
corte de dos lados  
rovesciabile graffiante



**1145/3 KL**  
13 cm

Halter für Mikro-Skalpellklingen  
Holder for micro blades  
Manche pour micro lames  
Mango para micro hojas  
Manico per micro lamette



**1136/1**  
15,5 cm

Zahnfleischmesser  
Gum Knives  
Couteau à gencives  
Bisturios para encias  
Coltelli per gengive



**1136/2**  
15 cm

# Dental



## Dental

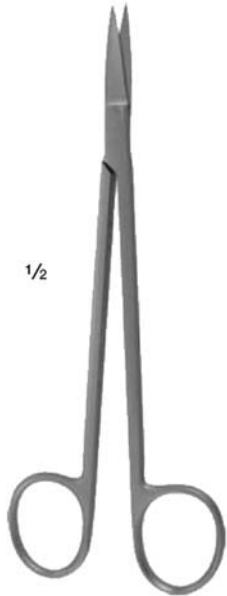

1/2

**1153/1**  
Kelly  
16 cm / 6 1/4"

gerade  
straight  
droits  
rectas  
diritte

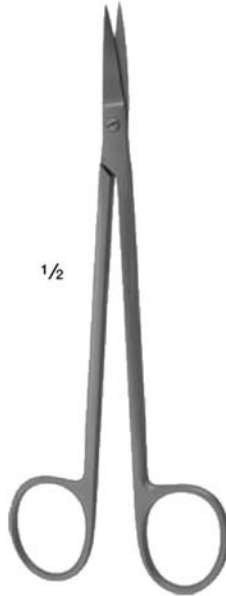

1/2

**1153/2**  
Kelly  
16 cm

gebogen  
curved  
courbés  
curvatura  
curve

**1153/20**  
Kelly „Super Cut“  
16 cm



1/2

**1155/1**  
Iris  
11 cm

gerade  
straight  
droits  
rectas  
diritte

**1155/10**  
Iris „Super Cut“  
11 cm



1/2

**1155/2**  
Iris  
11 cm

gebogen  
curved  
courbés  
curvatura  
curve

**1155/20**  
Iris „Super Cut“  
11 cm

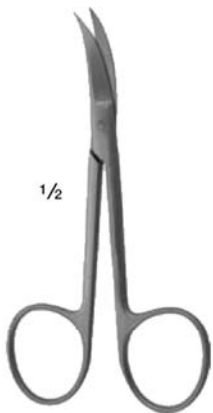

1/2

**1155/3**  
Iris  
11 cm

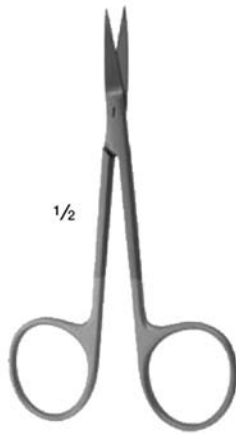

1/2

**1158/1**  
Iris „Wolfram-Carbid“  
11,5 cm / 4 1/2"

gerade  
straight  
droits  
rectas  
diritte



1/2

**1158/2**  
Iris „Wolfram-Carbid“  
11,5 cm / 4 1/2"

gebogen  
curved  
courbés  
curvatura  
curve

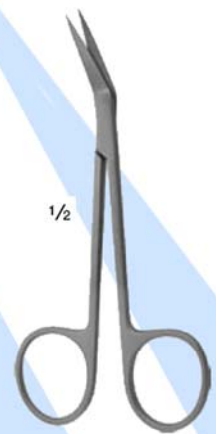

1/2

**1158/4**  
Iris „Wolfram-Carbid“  
11,5 cm / 4 1/2"



# MULTICRAFTS Corporation

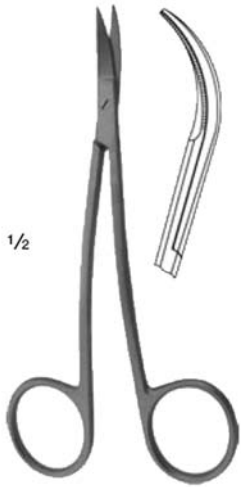

1/2

**1154/1**  
La Grange  
11,5 cm

S-gebogen  
S-curved  
S-courbés  
curvatura S  
curva a S

**1154/10**  
La Grange „Super Cut“  
11,5 cm

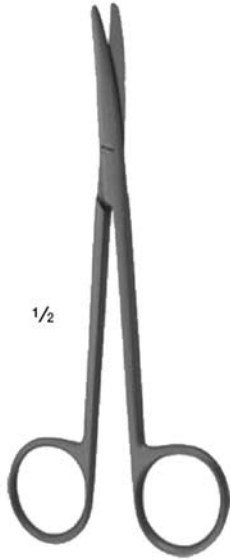

1/2

**1155/6**  
Metzenbaum  
15 cm

gebogen  
curved  
courbés  
curvatura  
curve

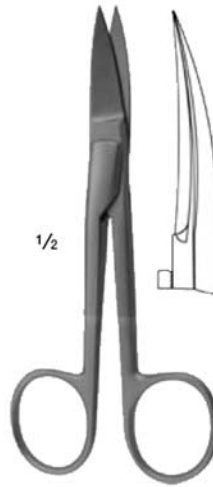

1/2

**1161 TC**  
Federschloßschere  
13 cm

gebogen  
curved  
courbés  
curvatura  
curve

TC =  
Hartmetalleinsätze  
Tungsten carbide inserts  
Pointes en tungstène  
Puntas de tungsteno  
Punte al carburo di tungsteno



1/2

**1162**  
Neumann  
12 cm

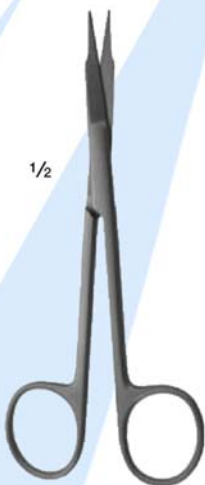

1/2

**1165/1**  
Goldman-Fox  
13 cm

gezahnt  
saw edge  
dentalés  
dentadas  
dentate

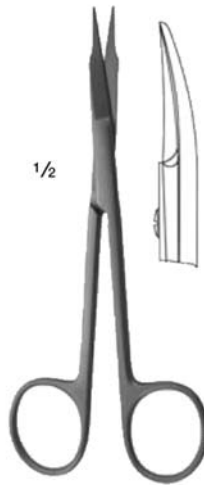

1/2

**1165/2**  
Goldman-Fox  
13 cm

gebogen  
curved  
courbés  
curvatura  
curve

gezahnt  
saw edge  
dentalés  
dentadas  
dentate

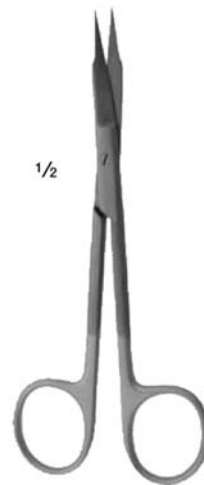

1/2

**1166/2**  
Goldman-Fox  
„Wolfram-Carbid“  
13 cm

gebogen  
curved  
courbés  
curvatura  
curve

# Dental



## Dental

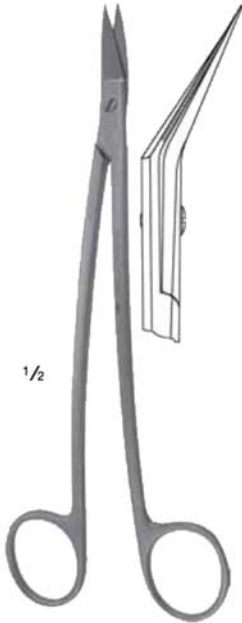

1/2

**1172**  
Dean  
17 cm

gezahnt  
saw edge  
dentelés  
dentadas  
dentate



1/2

**1173**  
Locklin  
„Wofram-Carbid“  
16 cm



1/2

**1168**  
11,5 cm

gebogen  
curved  
courbés  
curvatura  
curve



1/2

**1178**  
12 cm

stumpf-spitz  
blunt-pointed  
mousse-pointu  
romo-agudo  
smusso-appuntato



1/2

**1170**  
Micro-Scissor  
12 cm

gebogen  
curved  
courbés  
curvatura  
curve



1/2

**1170/5**  
Micro-Scissor  
15 cm

gebogen  
curved  
courbés  
curvatura  
curve

**1170 / 1**  
Micro-Scissor  
14,5 cm



**1191/1**  
9 cm

gebogen  
curved  
courbés  
curvatura  
curve

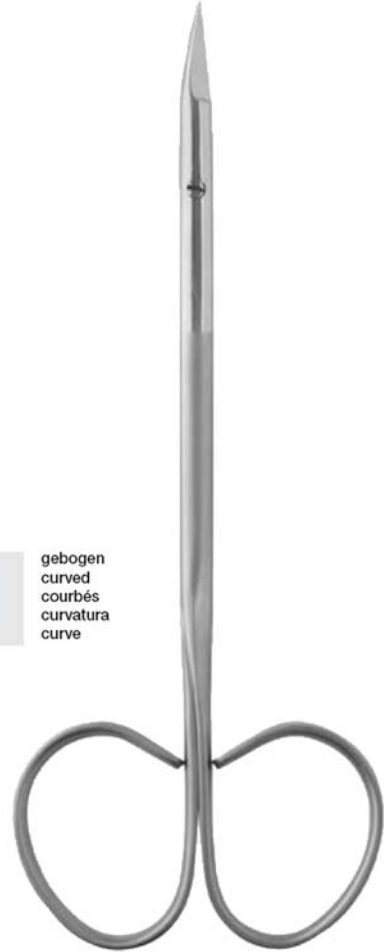

**1191/2**  
13 cm

gebogen  
curved  
courbés  
curvatura  
curve



**1190/1**  
Spencer  
9 cm

**PA 20**  
Spencer  
11 cm

**1190 / 2**  
Spencer  
13 cm



**PA 21**  
Spencer  
11 cm



**Dental**



**PA 18**  
13 cm



**2302/1**  
14,5 cm



**PA 17**  
16 cm



**PA 25**  
17 cm



**2310**

18 cm

Anatomische Pinzette  
Dressing Forceps  
Pince à dissection  
Pinza de disección  
Pinze per dissezione

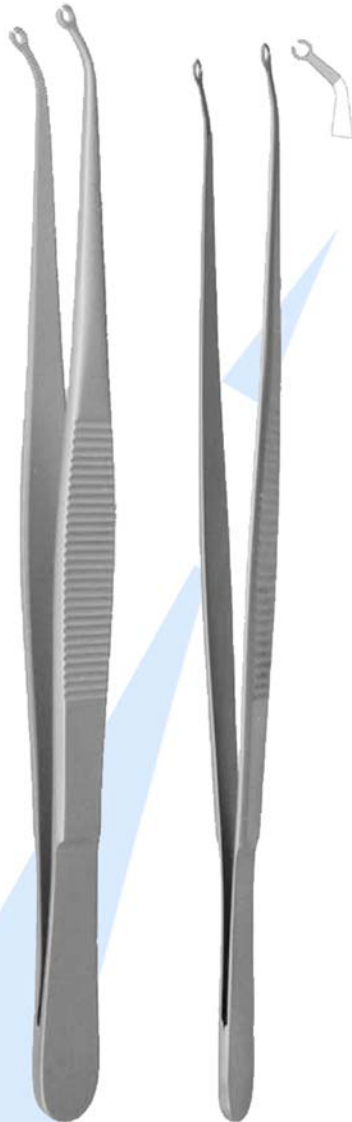

**2315/3**

16 cm

o 1,6 mm

**2315/4**

15,5 cm

o 2,2 mm

Naht- und Membranpinzette  
Suture and membrane forceps  
Pincettes à suture et à membrane  
Pinzas para suturas y membranas  
Pinzette per membrana e sutura



**2330/1**

16 cm

DeBakey 2,0 mm

Gefäßpinzetten / Atrauma  
Vascular Forceps / Atrauma  
Pincés à dissection vasculaires / Atrauma  
Pinzas de disección vascular / Atrauma  
Pinze per dissezione vascolari / Atrauma



**2330/2**

15,5 cm

DeBakey 2,0 mm

## Dental



## Dental



**2655**  
1,8 cc  
14 cm

Zylinder-Ampullen-Spritze  
Cartridge syringes  
Seringues d'ampoules  
Jeringas de ampollas  
Seringhe per tubofiale

mit Aspiration  
with aspiration device  
avec aspiration  
con aspiración  
con aspirazione

mit metrischem Gewinde  
with metric thread  
avec filetage métrique  
con rosca métrica  
con filettatura metrica



**2659**  
1,8 cc  
14 cm

Zylinder-Ampullen-Spritze  
Cartridge syringes  
Seringues d'ampoules  
Jeringas de ampollas  
Seringhe per tubofiale

mit Aspiration  
with aspiration device  
avec aspiration  
con aspiración  
con aspirazione

mit metrischem Gewinde  
with metric thread  
avec filetage métrique  
con rosca métrica  
con filettatura metrica



**2666**  
1,8 cc  
12,5 cm

Zylinder-Ampullen-Spritze  
Cartridge syringes  
Seringues d'ampoules  
Jeringas de ampollas  
Seringhe per tubofiale

ohne Aspiration  
without aspiration device  
sans aspiration  
sin aspiración  
senza aspirazione

mit metrischem Gewinde  
with metric thread  
avec filetage métrique  
con rosca métrica  
con filettatura metrica





**MULTICRAFTS** Corporation



**2665**  
10 cc  
21 cm

Ganzmetall Wasserspritze  
All metal water syringe  
Seringue à eau entièrement métallique  
Jeringas para agua, de metal  
Siringa per acqua interamente metallica

selbstfüllend  
self filling  
autoremplissant  
para relleno automático  
riempire automatico



Druckspritze  
Pressure syringe  
Seringue à pression  
Jeringa de presión

zur intra-ligamentalen Anästhesie, verwendbar mit Zylinder Ampullen 1,8 cc  
for intra-ligamental anesthesia, for use with cartridges of 1,8 cc  
pour l'anesthésie intra-ligamentaire, pour usage avec des ampoules de 1,8 cc  
para la anestesia intra-ligamentaria, para uso con ampollas de 1,8 cc

**2663**  
1,8 cc  
b= 15 cm x h = 9,5 cm

**Dental**



## Dental

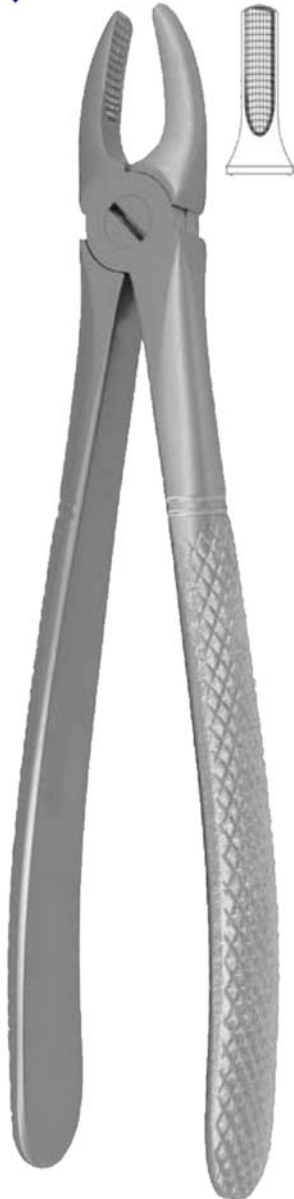

**400/1 H**  
# 1  
16 cm

**400/1 D**  
# 1  
16 cm

Schneide- und Eckzähne  
Incisors and cuspids  
Incisives et canines  
Incisivos y caninos  
Denti incisivi medi e denti canini



**400/2 H**  
# 2  
16 cm

**400/2 D**  
# 2  
16 cm



Seitliche Schneidezähne und Prämolaren  
Incisors and biscuspids  
Incisives et prémolaires  
Incisivos y premolares  
Denti incisivi laterali e denti premolari



**400/7 H**  
# 7  
16 cm

**400/7 D**  
# 7  
16 cm



Prämolaren  
Biscuspids  
Prémolaires  
Premolares  
Denti premolari



**400/17 H**  
# 17  
16 cm

**400/17 D**  
# 17  
16 cm



Molaren, rechts  
Molars, right  
Molaires, droit  
Molares, derecho  
Denti molari, destra



**400/18 H**  
# 18  
16 cm

**400/18 D**  
# 18  
16 cm



Molaren, links  
Molars, left  
Molaires, gauche  
Molares, izquierdo  
Denti molari, sinistra



**400/29 H**  
# 29  
16 cm

**400/29 D**  
# 29  
16 cm



Wurzeln  
Roots  
Racines  
Raíces  
Radici



**400/51 AH**  
# 51 A  
16 cm

**400/51 AD**  
# 51 A  
16 cm



Wurzeln  
Roots  
Racines  
Raíces  
Radici

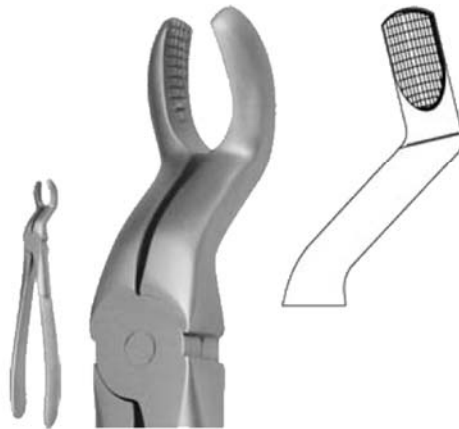

**400/67 H**  
# 67  
16 cm

**400/67 D**  
# 67  
16 cm



Dritte Molaren  
Third molars  
Troisièmes molaires  
Terceros molares  
Denti del giudizio





## Dental



**400/22 H**  
# 22  
14,5 cm

**400/22 D**  
# 22  
14,5 cm



Molaren  
Molars  
Molaires  
Molares  
Denti molari



**400/33 AH**  
# 33A  
14,5 cm

**400/33 AD**  
# 33A  
14,5 cm



Wurzeln  
Roots  
Racines  
Raíces  
Radici

**400/13 H**  
# 13  
14,5 cm

**400/13 D**  
# 13  
14,5 cm



Prämolaren  
Biscuspids  
Prémolaires  
Premolares  
Denti premolari



**400/73 D**  
# 73  
14,5 cm



Molaren  
Molars  
Molaires  
Molares  
Denti molari





**400/74 D**  
# 74  
14,5 cm



Schneidezähne und Wurzeln  
Incisors and roots  
Incisives et racines  
Incisivos y raíces  
Denti incisivi e radici



**400/74 NH**  
# 74 N  
14,5 cm

**400/74 ND**  
# 74 N  
14,5 cm



Schneidezähne und Wurzeln, schlankes Maul  
Incisors and roots, with fine beak  
Incisives et racines, avec un bec très fin  
Incisivos y raíces, con pico delgado  
Denti incisivi e radici, morso delicato



**400/79 H**  
# 79  
16 cm

**400/79 D**  
# 79  
16 cm



Dritte Molaren  
Third molars  
Troisièmes molaires  
Terceros molares  
Denti del giudizio



## Dental



**500/1**  
# 1  
17 cm

**650/1**  
# 1  
17 cm

Schneide- und Eckzähne  
Incisors and cuspids  
Incisives et canines  
Incisivos y caninos  
Denti incisivi medi e denti canini



**500/7**  
# 7  
16 cm

**650/7**  
# 7  
16 cm

Prämolaren  
Biscuspids  
Prémolaires  
Premolares  
Denti premolari



**500/17**  
# 17  
17 cm

**650/17**  
# 17  
17 cm

Molaren, rechts  
Molars, right  
Molaires, droit  
Molares, derecho  
Denti molari, destra

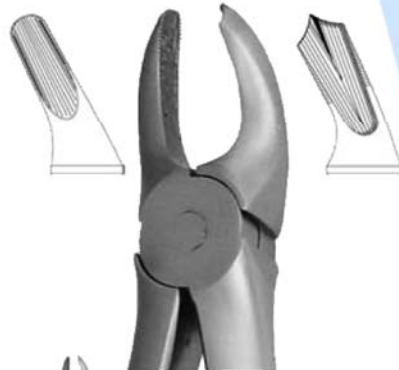

**500/18**  
# 18  
17 cm

**650/18**  
# 18  
17 cm

Molaren, links  
Molars, left  
Molaires, gauche  
Molares, izquierdo  
Denti molari, sinistra



**500/29**  
# 29  
17 cm

**650/29**  
# 29  
17 cm

Wurzeln  
Roots  
Racines  
Raíces  
Radici





**500/51 A**  
# 51A  
18,5 cm

**650/51 A**  
# 51A  
18,5 cm



Wurzeln  
Roots  
Racines  
Raíces  
Radici



**500/67 A**  
# 67A  
17 cm

**650/67 A**  
# 67A  
17 cm



Dritte Molaren  
Third molars  
Troisièmes molaires  
Terceros molares  
Denti del giudizio

**Dental**



## Dental



**500/4**  
# 4  
16 cm

**650/4**  
# 4  
16 cm

Schneide- und Eckzähne  
Incisors and cuspids  
Incisives et canines  
Incisivos y caninos  
Denti incisivi medi e denti canini

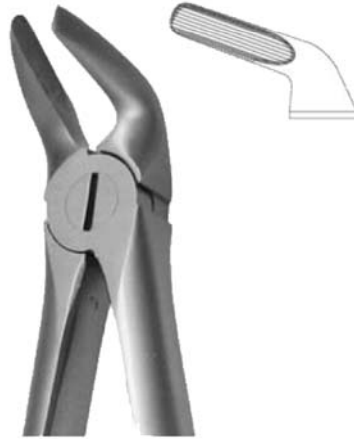

**500/8**  
# 8  
16 cm

**650/8**  
# 8  
16 cm

Prämolaren  
Biscuspids  
Prémolaires  
Premolares  
Denti premolari



**500/13**  
# 13  
15,5 cm

**650/13**  
# 13  
15,5 cm

Prämolaren  
Biscuspids  
Prémolaires  
Premolares  
Denti premolari



**500/22**  
# 22  
15,5 cm

**650/22**  
# 22  
15,5 cm

Molaren  
Molars  
Molaires  
Molares  
Denti molari



**500/33 A**  
# 33 A  
15 cm

**650/33 A**  
# 33 A  
15 cm

Wurzeln  
Roots  
Racines  
Raíces  
Radici





# MULTICRAFTS Corporation

# Dental

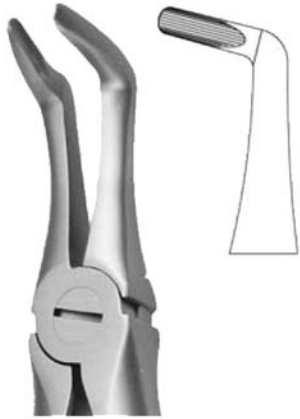

**500/45**  
# 45  
17 cm



**650/45**  
# 45  
17 cm



Wurzeln  
Roots  
Racines  
Raíces  
Radici



**500/74**  
# 74  
15 cm



**650/74**  
# 74  
15 cm



Wurzeln  
Roots  
Racines  
Raíces  
Radici



**500/74 XN**  
# 74 XN  
14,5 cm



**650/74 XN**  
# 74 XN  
14,5 cm



Schneidezähne & Wurzeln  
Incisors & Roots  
Incisivos & Racines  
Incisivos & Raíces  
Denti incisivi & Radici



**500/79**  
# 79  
17 cm



Dritte Molaren  
Third molars  
Troisième molaires  
Terceros molares  
Denti del giudizio

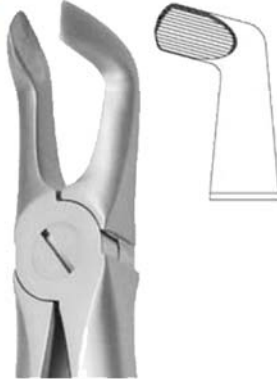

**500/79 A**  
# 79 A  
17 cm



**650/79 A**  
# 79 A  
17 cm



Dritte Molaren  
Third molars  
Troisième molaires  
Terceros molares  
Denti del giudizio



**500/87**  
# 87  
16 cm



Molaren  
Molars  
Molaires  
Molares  
Denti molari



## Dental



**1101 / P**  
# 1  
17 cm

**1101**  
# 1  
17 cm

Schneide- und Eckzähne  
Incisors and cuspids  
Incisives et canines  
Incisivos y caninos  
Denti incisivi medi e denti canini

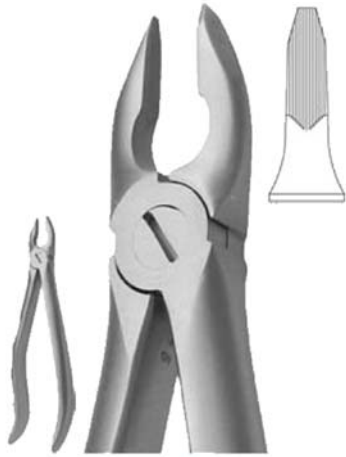

**1102 P**  
# 2  
17,5 cm

**1102**  
# 2  
17,5 cm

**1102 D**  
# 2  
17,5 cm

Schneide- und Eckzähne  
Incisors and cuspids  
Incisives et canines  
Incisivos y caninos  
Denti incisivi medi e denti canini

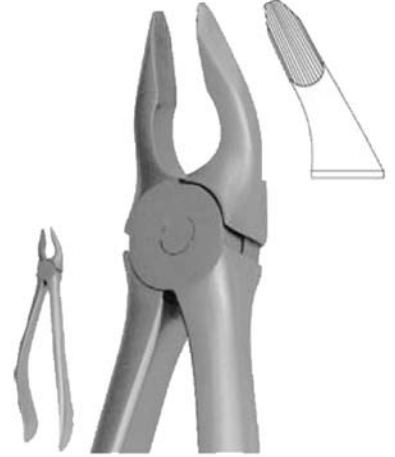

**1107 P**  
# 7  
16,5 cm

**1107**  
# 7  
16,5 cm

**1107 D**  
# 7  
16,5 cm

Prämolaren  
Biscuspids  
Prémolaires  
Premolares  
Denti premolari

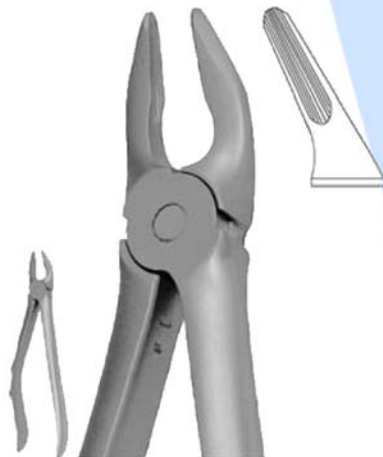

**1107 NP**  
# 7 N  
16 cm

**1107 N**  
# 7 N  
16 cm

Prämolaren  
Biscuspids  
Prémolaires  
Premolares  
Denti premolari





**1118 P**  
# 18  
17 cm

**1118**  
#18  
17 cm

Molaren, links  
Molars, left  
Molaires, gauche  
Molares, izquierdo  
Denti molari, sinistra

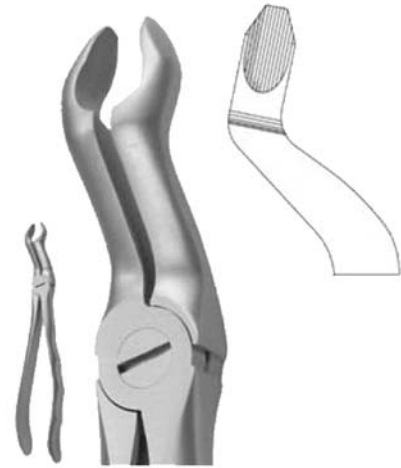

**1167 P**  
# 67  
17,5 cm

**1167**  
# 67  
17,5 cm

Dritte Molaren  
Third molars  
Troisièmes molaires  
Terceros molares  
Denti del giudizio

**1117 P**  
# 17  
17 cm

**1117**  
#17  
17 cm

Molaren, rechts  
Molars, right  
Molaires, droit  
Molares, derecho  
Denti molari, destra

# Dental



## Dental

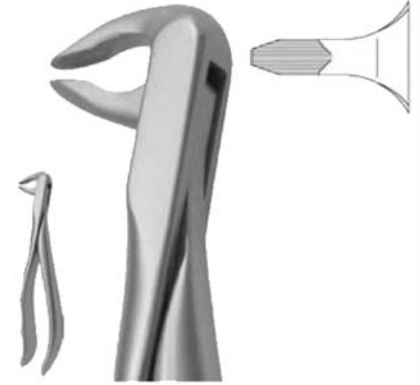
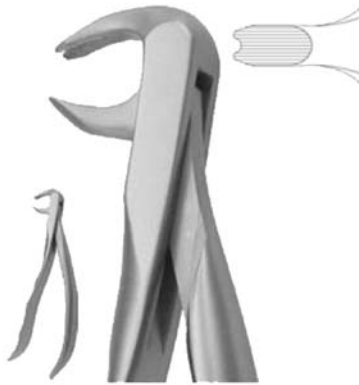

**1173 P**  
# 73  
14 cm

**1173 K**  
# 73  
14 cm

Molaren  
Molars  
Molaires  
Molares  
Denti molari

**1174 P**  
# 74  
15 cm

**1174**  
# 74  
15 cm

**1174 D**  
# 74  
15 cm



Schneide- und Eckzähne  
Incisors and cuspids  
Incisives et canines  
Incisivos y caninos  
Denti incisivi medi e denti canini

**1122 P**  
# 22  
15 cm

**1122 K**  
# 22  
15 cm

Molaren  
Molars  
Molaires  
Molares  
Denti molari

**1108 P**  
# 8  
16,5 cm

**1108**  
# 8  
16,5 cm

Prämolaren  
Biscuspids  
Prémolaires  
Premolares  
Denti premolari



**1174 NP**  
# 74 N  
14,5 cm

**1174 N**  
# 74 N  
14,5 cm

Prämolaren  
Bicuspidis  
Prémolaires  
Premolares  
Denti premolari

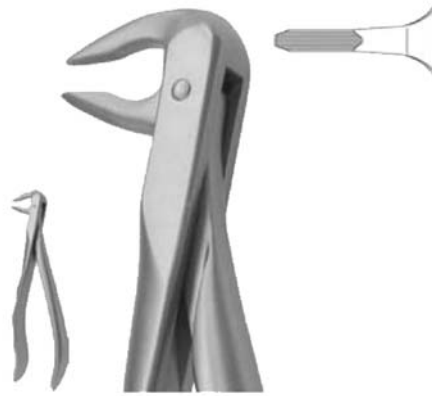

**1174 XNP**  
# 74 XN  
14,5 cm

**1174 XN**  
# 74 XN  
14,5 cm

Prämolaren  
Bicuspidis  
Prémolaires  
Premolares  
Denti premolari

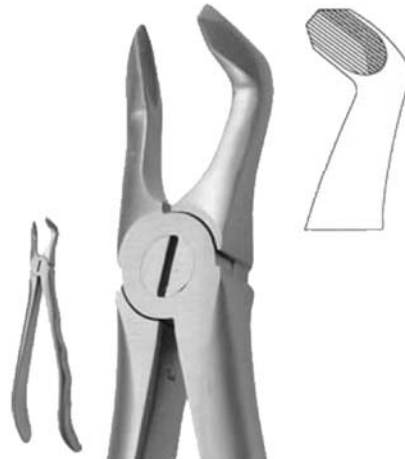

**1179 AP**  
# 79 A  
17 cm

**1179 A**  
# 79 A  
17 cm

Dritte Molaren  
Third molars  
Troisièmes molaires  
Terceros molares  
Denti del giudizio





# MULTICRAFTS Corporation

## Dental



- 1229 EP**  
# 29 E  
17 cm
- 1229 E**  
# 29 E  
17 cm
- 1229 ES**  
# 29 E  
17 cm

Wurzeln  
Roots  
Racines  
Raíces  
Radici

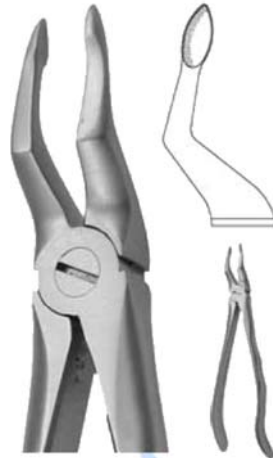

- 1251 EP**  
# 51 E  
16 cm
- 1251 E**  
# 51 E  
16 cm
- 1251 EPS**  
# 51 E  
16 cm
- 1251 ES**  
# 51 E  
16 cm

Wurzeln  
Roots  
Racines  
Raíces  
Radici

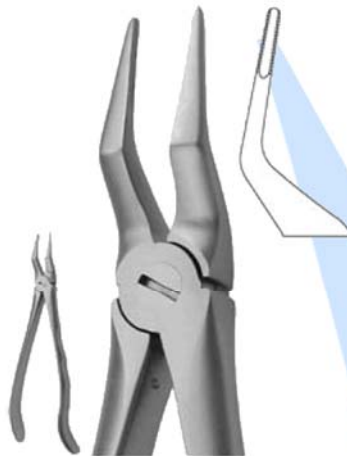

- 1251 NP**  
# 51 N  
16,5 cm
- 1251 N**  
# 51 N  
16,5 cm
- 1251 ND**  
# 51 N  
16,5 cm

Wurzeln  
Roots  
Racines  
Raíces  
Radici

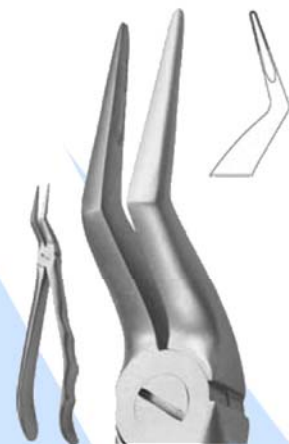

- 1296 AP**  
# 96 A  
19,5 cm

Wurzeln  
Roots  
Racines  
Raíces  
Radici





**1245 P**  
# 45  
17 cm

**1245**  
# 45  
17 cm

**1245 D**  
# 45  
17 cm

Wurzeln  
Roots  
Racines  
Raíces  
Radici

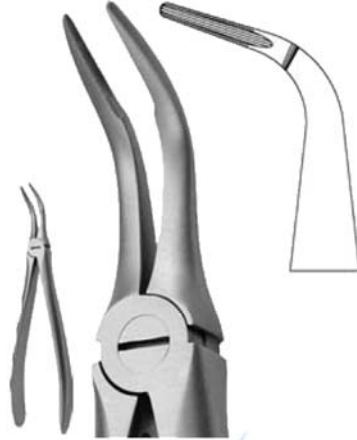

**1246 P**  
# 46  
19 cm

Wurzeln  
Roots  
Racines  
Raíces  
Radici

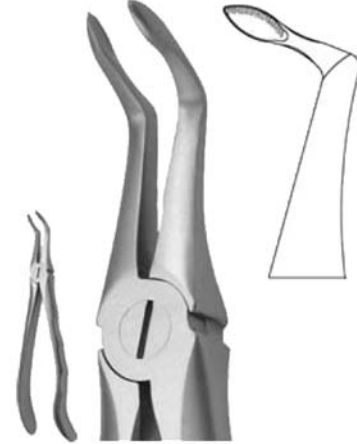

**1249 P**  
# 49  
17,5 cm

**1249**  
# 49  
17,5 cm

**1249 PS**  
# 49  
17,5 cm

**1249 S**  
# 49  
17,5 cm

Wurzeln  
Roots  
Racines  
Raíces  
Radici



**1274 EP**  
# 74 E  
14,5 cm

**1274 E**  
# 74 E  
14,5 cm

**1274 EPS**  
# 74 E  
14,5 cm

**1274 ES**  
# 74 E  
14,5 cm

Wurzeln  
Roots  
Racines  
Raíces  
Radici



**1290 AP**  
# 90 A  
15 cm

**1290 A**  
# 90 A  
15 cm

Wurzeln  
Roots  
Racines  
Raíces  
Radici





## Dental



**500 / 37**  
# 37  
14,5 cm

Schneidezähne- und Eckzähne  
Incisors and cuspids  
Incisives et canines  
Incisivos y caninos  
Denti incisivi e denti canini



**500/39 R**  
# 39 R  
14,5 cm

**650/39 R**  
# 39 R  
14,5 cm

Molaren, rechts  
Molars, right  
Molaires, droit  
Molares, derecho  
Denti molari, destra



**500/39 L**  
# 39 L  
14,5 cm

**650/39 L**  
# 39 L  
14,5 cm

Molaren, links  
Molars, left  
Molaires, gauche  
Molares, izquierdo  
Denti molari, sinistra





**560**  
Klein # 137  
10,5 cm

Schneidezähne- und Eckzähne  
Incisors and cuspids  
Incisives et canines  
Incisivos y caninos  
Denti incisivi e denti canini



**561**  
Klein # 139  
10,5 cm

Prämolaren  
Biscuspids  
Prémolaires  
Premolares  
Denti premolari



**562**  
Klein # 51 S  
12 cm

Wurzeln  
Roots  
Racines  
Raíces  
Radici



**563**  
Klein # 3  
12 cm

Molaren  
Molars  
Molaires  
Molares  
Denti molari

# Dental

# Dental



**600/101 AS**  
# 101 AS  
15,5 cm

**600/101 ASP**  
# 101 AS  
15,5 cm

Zähne, universal  
Teeth, universal  
Dentes, universal  
Dientes, universal  
Denti, universale

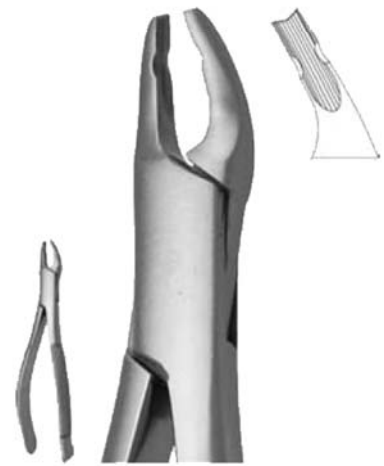

**600/150 AS**  
# 150 AS  
15,5 cm

Zähne, universal  
Teeth, universal  
Dentes, universal  
Dientes, universal  
Denti, universale



**600/150 S**  
Cryer # 150 S  
15,5 cm

Zähne und Wurzeln, universal  
Teeth and roots, universal  
Dentes et racines, universal  
Dientes y raíces, universal  
Denti e radici, universale

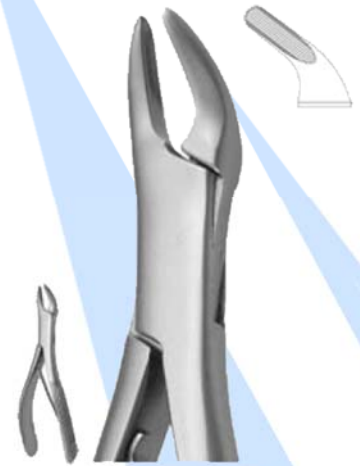

**645/150 SK**  
# 150 SK  
12,5 cm

Zähne und Wurzeln, universal  
Teeth and roots, universal  
Dentes et racines, universal  
Dientes y raíces, universal  
Denti e radici, universale





**133 AS**

12,5 cm

**133 ASP**

12,5 cm

Zähne, universal  
Teeth, universal  
Dentes, universal  
Dientes, universal  
Denti, universale



**500/13 S**  
# 13 S  
13 cm

Prämolaren  
Biscuspids  
Prémolaires  
Premolares  
Denti premolari



**500/22 S**  
# 22 S  
13 cm

**650/22 S**  
# 22 S  
13 cm

Molaren  
Molars  
Molaires  
Molares  
Denti molari



**565**  
Klein # 5  
10,5 cm

Schneidezähne  
Incisors  
Incisives  
Incisivos  
Denti incisivi



**566**  
Klein # 6  
10,5 cm

Molaren  
Molars  
Molaires  
Molares  
Denti molari



**567**  
Klein # 7  
10,5 cm

Wurzeln  
Roots  
Racines  
Raíces  
Radici





## Dental



**600/151 AS**  
# 151 AS  
15 cm

Zähne, universal  
Teeth, universal  
Dentes, universel  
Dientes, universal  
Denti, universale



**600/151 S**  
# 151 S  
14,5 cm

Zähne und Wurzeln, universal  
Teeth and roots, universal  
Dentes et racines, universel  
Dientes y raíces, universal  
Denti e radici, universale

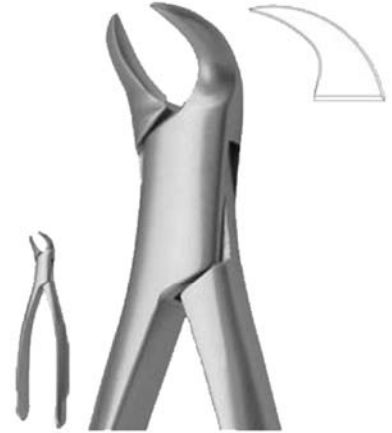

**640/23 S**  
# 23 S  
14,5 cm

Molaren  
Molars  
Molaires  
Molares  
Denti molari



**645/17 SK**  
# 17 SK  
12 cm

Molaren  
Molars  
Molaires  
Molares  
Denti molari

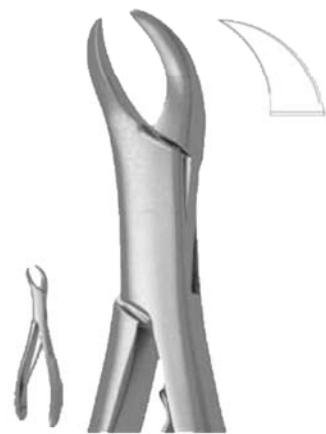

**645/23 SK**  
# 23 SK  
12 cm

Molaren  
Molars  
Molaires  
Molares  
Denti molari

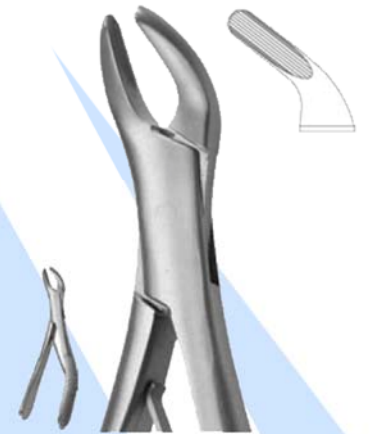

**645/151 SK**  
# 151 SK  
12 cm

**645/151 SKP**  
# 151 SKP  
12 cm

Zähne und Wurzeln, universal  
Teeth and roots, universal  
Dentes et racines, universel  
Dientes y raíces, universal  
Denti e radici, universale



**111 P**  
# special  
17 cm

Schneide- und Eckzähne  
Incisors and cuspids  
Incisives et canines  
Incisivos y caninos  
Denti incisivi medi e denti canini



**144**  
# special  
19 cm

**144 P**  
# special  
19 cm

Wurzeln  
Roots  
Racines  
Raíces  
Radici

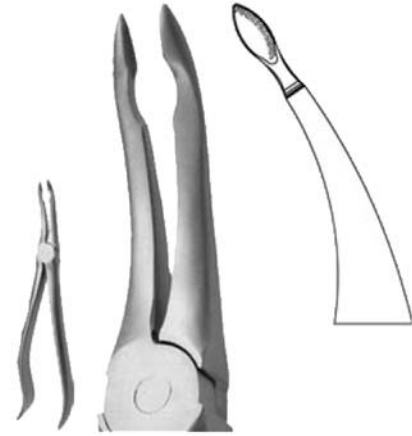

**144 E**  
# special  
18,5 cm

**144 EP**  
# special  
18,5 cm

**144 EPS**  
# special  
18,5 cm

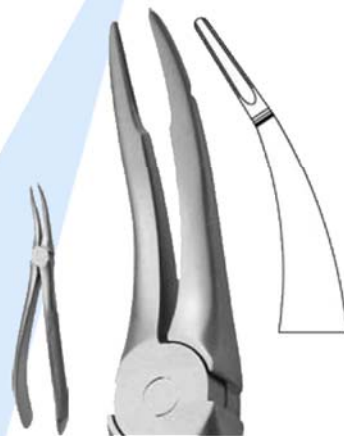

**144 S**  
# special  
18,5 cm

**144 SP**  
# special  
18,5 cm

Wurzeln  
Roots  
Racines  
Raíces  
Radici



**1219**  
# special  
16 cm

**1219 P**  
# special  
16 cm

Dritte Molaren  
Third molars  
Troisièmes molaires  
Terceros molares  
Denti del giudizio



## Dental



**22 1/2 R**  
# special  
17,5 cm

**22 1/2 RP**  
# special  
17,5 cm

Molaren und dritte Molaren  
Molars and third molars  
Molaires et troisièmes molaires  
Molares y terceros molares  
Denti molari e denti del giudizio



**22 1/2 L**  
# special  
17,5 cm

**22 1/2 LP**  
# special  
17,5 cm

Molaren und dritte Molaren  
Molars and third molars  
Molaires et troisièmes molaires  
Molares y terceros molares  
Denti molari e denti del giudizio



**79 AS**  
# special  
17 cm

Dritte Molaren  
Third molars  
Troisièmes molaires  
Terceros molares  
Denti del giudizio

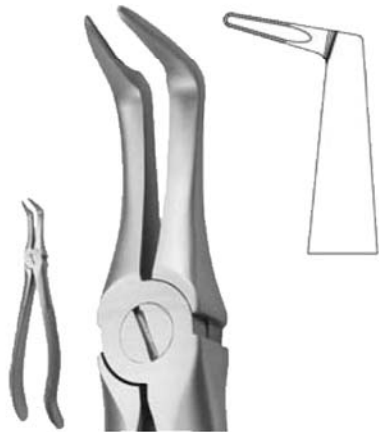

**145**  
# special  
17 cm

Wurzeln  
Roots  
Racines  
Raíces  
Radici



**522 P**  
# special  
15 cm

Molaren  
Molars  
Molaires  
Molares  
Denti molari



**586**  
# special  
15,5 cm

**586 P**  
# special  
15,5 cm

Molaren  
Molars  
Molaires  
Molares  
Denti molari



# MULTICRAFTS Corporation



**602 P**  
# special  
16,5 cm

Dritte Molaren  
Third molars  
Troisièmes molaires  
Terceros molares  
Denti del giudizio



**605 P**  
# special  
14,5 cm

Wurzeln  
Roots  
Racines  
Raíces  
Radici



**605 D**  
# special  
14,5 cm

Wurzeln  
Roots  
Racines  
Raíces  
Radici



**606 D**  
# special  
14,5 cm

Wurzeln  
Roots  
Racines  
Raíces  
Radici



# Dental



## Dental



**600/W 1**  
# 1 Winter  
19 cm

Schneidezähne- und Eckzähne  
Incisors and cuspids  
Incisives et canines  
Incisivos y caninos  
Denti incisivi e denti canini



**600/1 AS**  
# 1 AS  
17,5 cm

Schneidezähne- und Eckzähne  
Incisors and cuspids  
Incisives et canines  
Incisivos y caninos  
Denti incisivi e denti canini

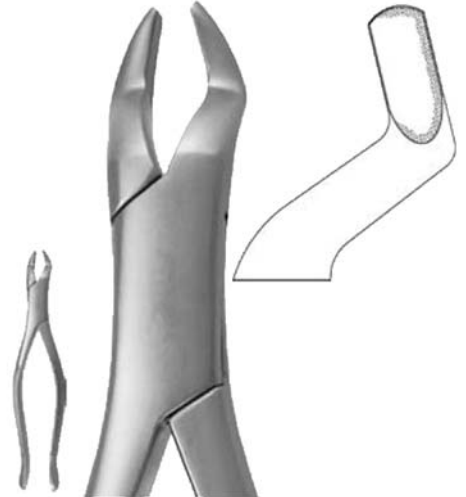

**600/10 S**  
# 10 S  
18 cm

Molaren und dritte Molaren  
Molars and third molars  
Molaires et troisièmes molaires  
Molares y terceros molares  
Denti molari e denti del giudizio

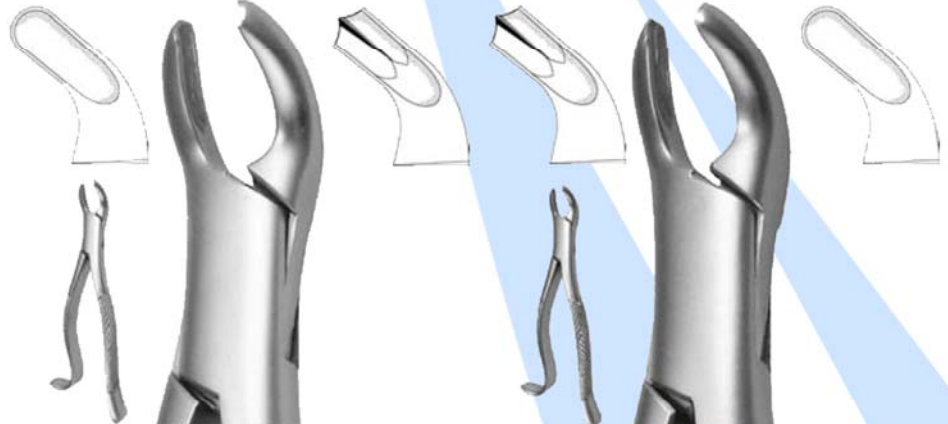
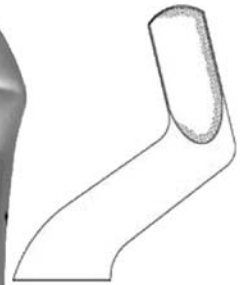

**600/18 L**  
# 18 L  
17 cm

Molaren, links  
Molars, left  
Molaires, gauche  
Molares, izquierdo  
Denti molari, sinistra



**600/18 R**  
# 18 R  
17 cm

Molaren, rechts  
Molars, right  
Molaires, droit  
Molares, derecho  
Denti molari, destra







**600/32**  
# 32 Parmsly  
19 cm

Molaren, Prämolaren und Wurzeln  
Molars, bicuspid and roots  
Molaires, prémolaires et racines  
Molares, premolares y raices  
Denti molari, denti premolari e radici

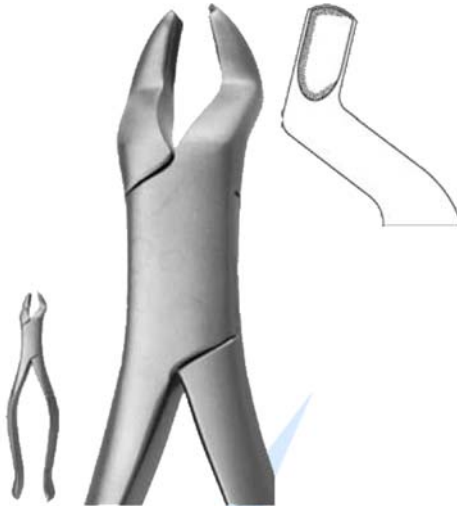

**600/53 L**  
# 53 L  
18 cm

Molaren, links  
Molars, left  
Molaires, gauche  
Molares, izquierdo  
Denti molari, sinistra

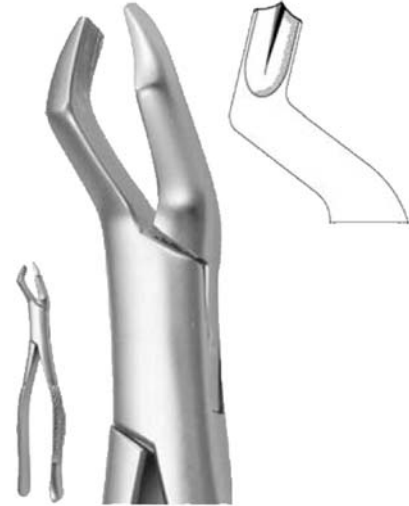

**600/53 R**  
# 53 R  
18 cm

Molaren, rechts  
Molars, right  
Molaires, droit  
Molares, derecho  
Denti molari, destra

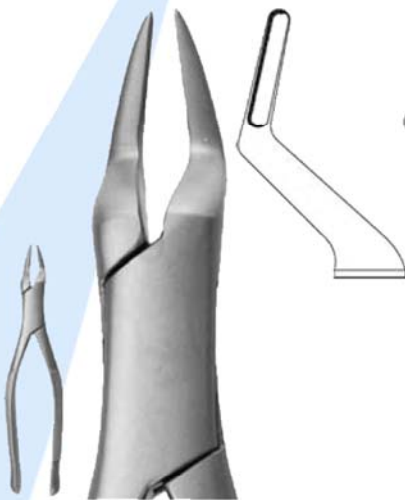

**600/65**  
# 65  
19 cm

Schneidezähne und Wurzeln  
Incisors and roots  
Incisives et racines  
Incisivos y raices  
Denti incisivi e radici

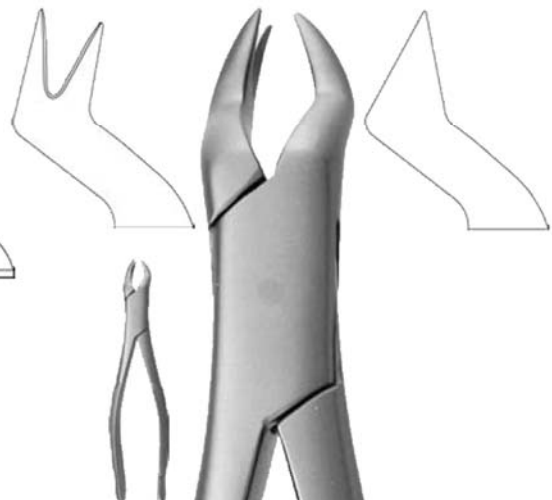

**600/88 L**  
# 88 L Nevius  
18,5 cm

Molaren, links  
Molars, left  
Molaires, gauche  
Molares, izquierdo  
Denti molari, sinistra



## Dental



**600 / 88 R**  
# 88 R Nevius  
18,5 cm

Molaren, rechts  
Molars, right  
Molaires, droit  
Molares, derecho  
Denti molari, destra

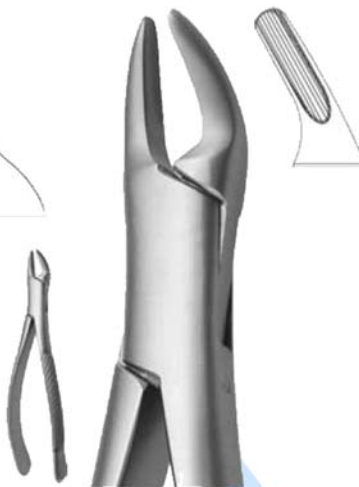

**600 / 150**  
# 150 Cryer  
18 cm

**600 / 150 D**  
# 150 Cryer  
18 cm



Prämolaren, Schneidzähne und Wurzeln  
Bicuspid, incisors and roots  
Prémolaires, incisives et racines  
Premolares, incisivos y raíces  
Denti premolari, denti incisivi e radici

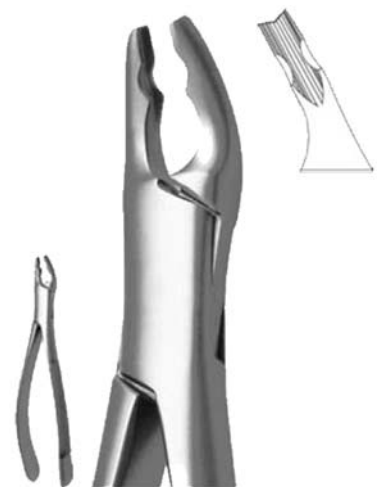

**600 / 150 AB**  
# 150 AB  
18 cm

Prämolaren, Schneidzähne und Wurzeln  
Bicuspid, incisors and roots  
Prémolaires, incisives et racines  
Premolares, incisivos y raíces  
Denti premolari, denti incisivi e radici

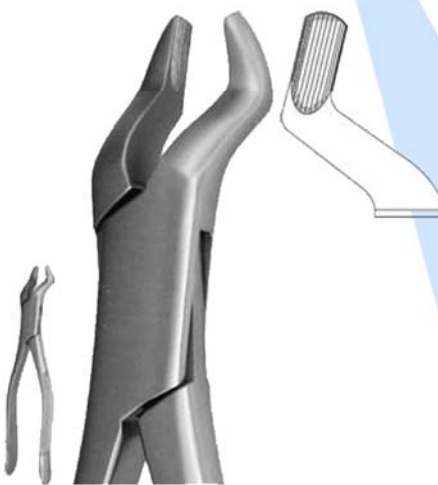

**600 / 210 S**  
# 210 S  
17,5 cm

Dritte Molaren  
Third molars  
Troisième molaires  
Terceros molares  
Denti del giudizio

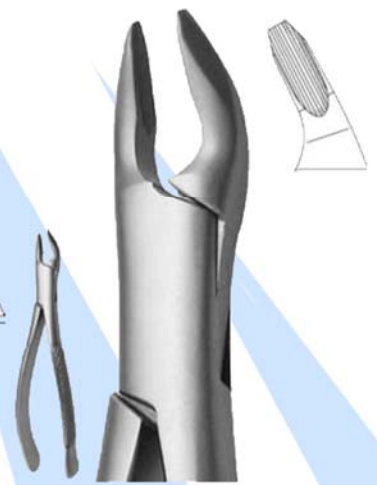

**600 / 273**  
# 273  
18 cm

**600 / 273 D**  
# 273  
18 cm



Prämolaren, Schneidzähne und Wurzeln  
Bicuspid, incisors and roots  
Prémolaires, incisives et racines  
Premolares, incisivos y raíces  
Denti premolari, denti incisivi e radici



**600 / 286**  
# 286  
18 cm

**600 / 286 D**  
# 286  
18 cm



Schneidezähne und Wurzeln  
Incisors and roots  
Incisives et racines  
Incisivos y raíces  
Denti incisivi e radici



**635 / 89**  
# 89  
17 cm

Molaren, rechts  
Molars, right  
Molaires, droit  
Molares, derecho  
Denti molari, destra



**635 / 90**  
# 90  
17 cm

Molaren, links  
Molars, left  
Molaires, gauche  
Molares, izquierdo  
Denti molari, sinistra





## Dental



**600 / 17**  
# 17  
17 cm

Molaren  
Molars  
Molaires  
Molares  
Denti molari

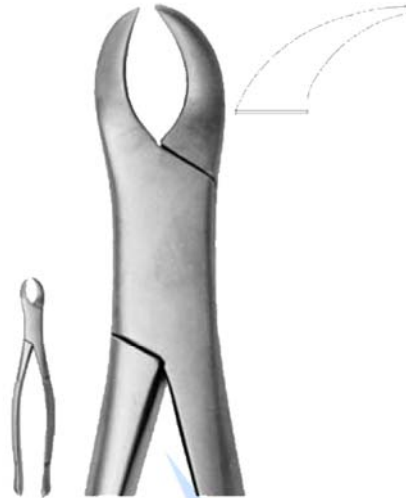

**600 / 23**  
# 23  
16,5 cm

Molaren  
Molars  
Molaires  
Molares  
Denti molari

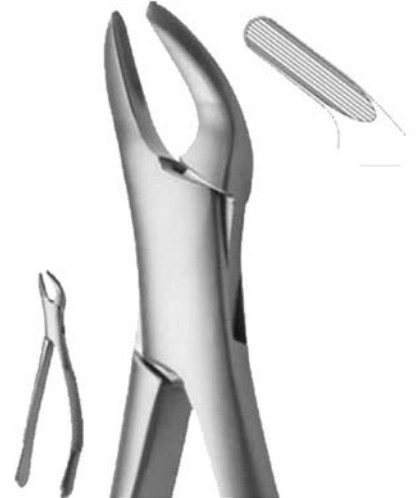

**600 / 151**  
# 151 Cryer  
17 cm

**600 / 151 D**  
# 151 Cryer  
17 cm

Prämolaren, Schneidezähne und Wurzeln  
Bicuspidis, incisors and roots  
Prémolaires, incisives et racines  
Premolares, incisivos y raíces  
Denti premolari, denti incisivi e radici



**600 / 151 AB**  
# 151 AB  
17 cm

Prämolaren, Schneidezähne und Wurzeln  
Bicuspidis, incisors and roots  
Prémolaires, incisives et racines  
Premolares, incisivos y raíces  
Denti premolari, denti incisivi e radici

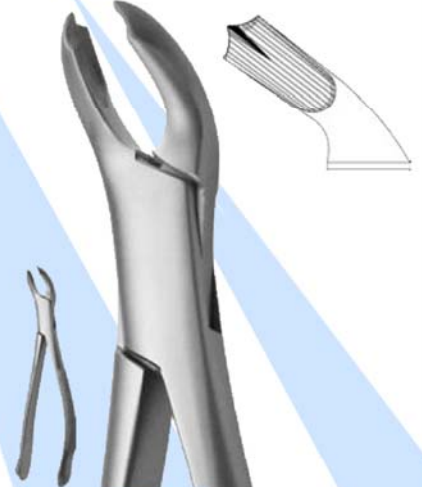

**600 / 217**  
# 217  
16,5 cm

Dritte Molaren  
Third molars  
Troisième molaires  
Terceros molares  
Denti del giudizio



# MULTICRAFTS Corporation



**600 / 222**  
# 222  
18 cm

Molaren  
Molars  
Molaires  
Molares  
Denti molari

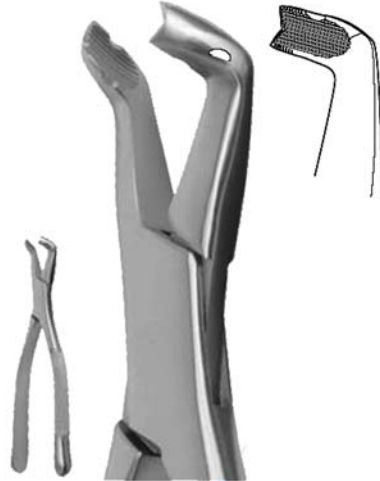

**600 / 222 AS**  
# 222 AS  
17,5 cm

Dritte Molaren  
Third molars  
Troisièmes molaires  
Terceros molares  
Denti del giudizio

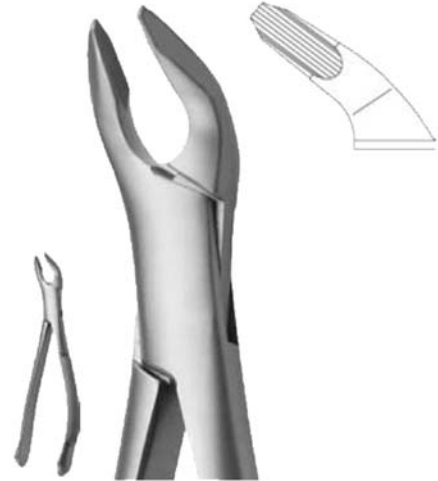

**600 / 274**  
# 274  
16,5 cm

**600 / 274 D**  
# 274  
16,5 cm

Prämolaren, Schneidezähne und Wurzeln  
Biscuspids, incisors and roots  
Prémolaires, incisives et racines  
Premolares, incisivos y raíces  
Denti premolari, denti incisivi e radici



**600 / 274 N**  
# 274 N  
17 cm

Prämolaren, Schneidezähne und Wurzeln  
Biscuspids, incisors and roots  
Prémolaires, incisives et racines  
Premolares, incisivos y raíces  
Denti premolari, denti incisivi e radici

# Dental



## Dental



**680/1**  
Bein  
2 mm  
14 cm



**21**  
Bein  
2,5 mm  
12,5 cm



**680/2**  
Bein  
3 mm  
14 cm



**680/3**  
Bein  
4 mm  
14 cm



**1**  
Bein  
3 mm  
12,5 cm



**17**  
Bein  
4 mm  
12,5 cm



**725 / 3**  
Bein  
3 mm  
13,5 cm



**725 / 4**  
Bein  
4 mm  
13,5 cm



**725/505**  
Kratzmann  
Universal  
13 cm



**60 M**  
4 mm  
12,5 cm



**64**  
3 mm  
12,5 cm



**680/10**  
Kopp  
14 cm



**680/11**  
Kopp  
14 cm



**65**  
3 mm  
14 cm



**34**  
5 mm  
12,5 cm



**48**  
4 mm  
14,5 cm



**47**  
3 mm  
15 cm



**47 U**  
3 mm  
15 cm

## Dental



## Dental



**24 P**  
2,5 mm  
15 cm

fein gezahnt  
fine serrated  
denté fin  
dentado fino  
dentato fino



**25 P**  
2,5 mm  
15 cm

fein gezahnt  
fine serrated  
denté fin  
dentado fino  
dentato fino



**26 P**  
2,5 mm  
15 cm

fein gezahnt  
fine serrated  
denté fin  
dentado fino  
dentato fino



**25**  
2,5 mm  
15 cm



**26**  
2,5 mm  
15 cm



**790 / 95**  
Omega  
15 cm



**32**  
2,5 mm  
13,5 cm



**790/1**  
# 1 Coupland  
3 mm  
14,5 cm



**790/2**  
# 2 Coupland  
3,5 mm  
15 cm



**790/3**  
# 3 Coupland  
4 mm  
15 cm



**790/301**  
# 301  
14 cm





# MULTICRAFTS Corporation



**794 / 60**  
# 60  
4 mm  
14 cm



**794 / 61**  
# 60 R  
4 mm  
14 cm



**794 / 62**  
# 60 L  
4 mm  
14 cm



**726 / 8**  
Crane-Pick  
14,5 cm



**726/25**  
14,5 cm



**726/26**  
14,5 cm



**726/34 S**  
Wolf  
14,5 cm



**735/1**  
Hyllin  
4,5 mm  
15 cm



**735/2**  
Hyllin  
3 mm  
15 cm

# Dental



## Dental



**700/1**  
14,5 cm



**700/8**  
Heidbrink  
15 cm



**700/9**  
Heidbrink  
14,5 cm



**700/10**  
Heidbrink  
14,5 cm



**700/36**  
Heidbrink  
14 cm



**700/37**  
Heidbrink  
14 cm

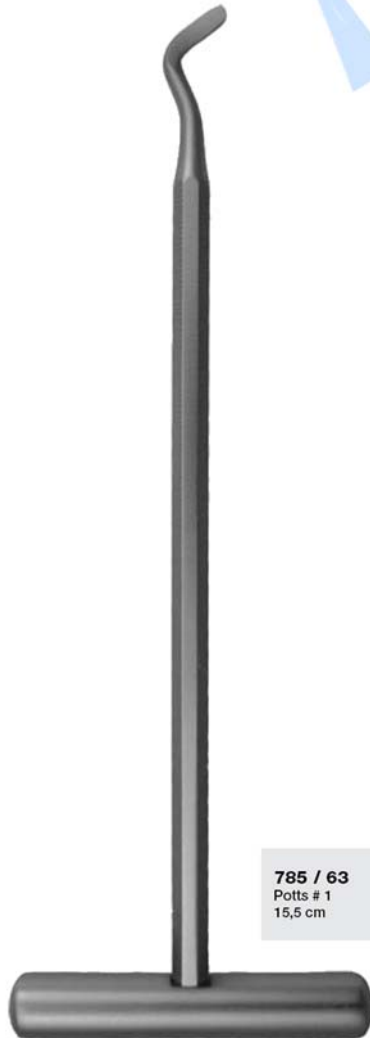

**785 / 63**  
Potts # 1  
15,5 cm

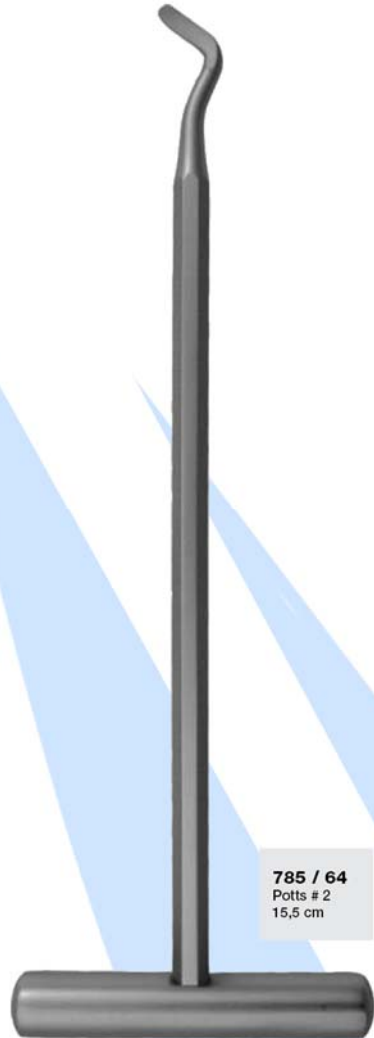

**785 / 64**  
Potts # 2  
15,5 cm



# MULTICRAFTS Corporation



**775 / 1**  
Winter  
# 1 L  
12 cm



**775 / 2**  
Winter  
# 1 R  
12 cm



**775 / 3**  
Winter  
# 11 L  
11,5 cm



**775/4**  
Winter  
# 11 R  
11,5 cm



**775/5**  
Winter  
# 12 L  
12 cm



**775/6**  
Winter  
# 12 R  
12 cm



**775/7**  
Winter  
# 13 R  
12 cm



**775/8**  
Winter  
# 13 R  
12 cm



**775/9**  
Winter  
# 14 L  
12,5 cm



**775/10**  
Winter  
# 14 R  
12,5 cm

# Dental



## Dental



**775 / 68**  
12,5 cm

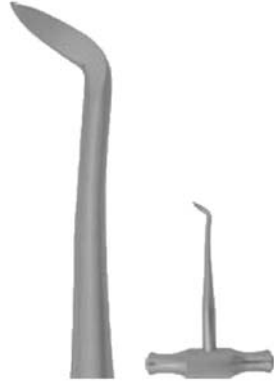

**775 / 69**  
12,5 cm



**780/1**  
Barry # 320  
11,5 cm



**780/2**  
Barry # 321  
11,5 cm



**780/7**  
Barry # 370  
12 cm



**780/8**  
Barry # 371  
12 cm



**777/14 L**  
12,5 cm



**777/14 R**  
12,5 cm



**52**  
3 mm  
15 cm



**53**  
3,5 mm  
15 cm



**54**  
4,5 mm  
15 cm



**60**  
4 mm  
15 cm



**60 B**  
4 mm  
15 cm



**60 U**  
4 mm  
16 cm



**60 R**  
4 mm  
15 cm



**60 L**  
4 mm  
15 cm



**60 BR**  
4 mm  
16 cm



**60 BL**  
4 mm  
16 cm

## Dental



## Dental



**63**  
4 mm  
15 cm



**66 B**  
5 mm  
15 cm



**66**  
5 mm  
15 cm



**69**  
4 mm  
15 cm



**64 A**  
3 mm  
15 cm



**67 R**  
4 mm  
15,5 cm

**67 L**  
4 mm  
15,5 cm



**68 R**  
4 mm  
15 cm

**68 L**  
4 mm  
15 cm



**68 A**  
4 mm  
14,5 cm



**68 B**  
4 mm  
14,5 cm



**85**  
Pivot Point  
3 mm  
15 cm



**85 U**  
Pivot Point  
3 mm  
16,5 cm



**85 B**  
Pivot Point  
3 mm  
16,5 cm

### Pivot Point Elevator-Series

Durch den Parabelschliff an der Instrumentenspitze und dem rautenförmigen Plateau ist ein schonendes Eindringen in den Interdentalraum bzw. Periodontalspalt optimal gewährleistet. Bedingt durch die Formgebung sind durch 180° Drehung vier Luxationsbewegungen möglich, je 2 x mesial und 2 x distal. Der Hebel arbeitet während des Luxationsvorgangs mit 5-7 Hypomochlien (Dreh- und Stützbewegungen). Dadurch ist er jedem herkömmlichen Hebel deutlich überlegen. Besonders wird die Luxation durch den Wellenschliff am Instrumentenrand begünstigt. Bedingt durch die Formgebung ist eine axial hebelnde Belastung der Instrumentenspitzen zu vermeiden, da dies zu Bruch führen kann.

The elliptically ground area on the instrument tip and the diamond-shaped plateau permit it to penetrate the interdental space and periodontal cleft optimally. Designed for 180° rotation for 4 luxation movements: 2 x mesial and 2 x distal. During luxation, the elevator exerts 5-7 hypomochlions (rotation and supporting actions), which is vastly superior to any conventional elevator. The grooves on the edge of the instrument provide for especially efficient luxation. The instrument tips are not designed for axial leverage as this may cause them to fracture.

Du fait de la taille elliptique de l'extrémité de l'instrument et du plateau losangique, une pénétration atraumatique dans l'espace inter-dentaire ou l'espace parodontal est assurée de manière optimale. La forme même permet aussi, par des rotations sur 180°, d'effectuer 4 mouvements de luxation, 2 du côté distal et 2 du côté mésial. Au cours de la manœuvre de luxation, l'élevateur travaille avec 5 à 7 sites d'hypomochlion (mouvements de rotation et d'appui). De ce fait, cet instrument est de loin supérieur à tout autre élévateur (max. 1 à 2 sites d'hypomochlion). La luxation est particulièrement facilitée par la présence de la taille ondulée dont sont pourvus les bords tranchants de l'instrument. Du fait de la forme de l'instrument, il faut éviter de soumettre l'extrémité de l'instrument à un effort de levier car cela peut provoquer sa fracture.

El rectificaco elíptico sobre la punta del instrumento y la plataforma romboidal permiten la inserción óptima, no agresiva, en el espacio interproximal o el resquecio periodontal. El diseño del instrumento posibilita 4 movimientos de luxación al realizar un giro de 180°: 2 x mesial y 2 x distal. La palanca trabaja con 5-7 movimientos de giro y apoyo. Por este motivo es superior a cualquier palanca convencional. (máx 1-2 movimientos de giro y apoyo). La luxación es favorecida particularmente por la ondulación mecanizada sobre el margen del instrumento. Por la forma de los instrumentos deberá evitarse una carga de palanca axial sobre las puntas de los mismos, puesto que esto podría provocar su rotura.



**85 A**  
Pivot Point  
3 mm  
15 cm



**86**  
Pivot Point  
3,5 mm  
15 cm



**86 R**  
Pivot Point  
3,5 mm  
15 cm



**86 L**  
Pivot Point  
3,5 mm  
15 cm



**87**  
Pivot Point  
4 mm  
15 cm



## Dental



**720/1**  
Apical  
#301  
15 cm



**720 / 2**  
Apical  
# 302  
15,5 cm



**720 / 3**  
Apical  
# 303  
15,5 cm



**720 / 4**  
Apical  
# 304  
15 cm



**720 / 1 C**  
4,5 mm  
15 cm



**720 / 1 S**  
4,5 mm  
15 cm



**720 / 2 C**  
4 mm  
15 cm



**720 / 2 S**  
4 mm  
15 cm



**720 / 3 C**  
3,5 mm  
15 cm



**720 / 3 S**  
3,5 mm  
15 cm



**720 / 4 C**  
3 mm  
15 cm



**720 / 4 S**  
3 mm  
14,5 cm



**720 / 5 C**  
2,5 mm  
15 cm



**720 / 5 S**  
2,5 mm  
15 cm



**720 / 10 C**  
6 mm  
15 cm



**720 / 10 S**  
6 mm  
15 cm





# MULTICRAFTS Corporation



**720/12 B**  
# 12 B Krogh  
15,5 cm



**720/6**  
Seldin # 34 S  
15,5 cm



**720/7**  
Seldin # 34  
15,5 cm



**720/12**  
Seldin # 3  
15,5 cm



**720/15**  
Seldin # 2  
16 cm



**720/21**  
Seldin # 1 L  
16 cm



**720/22**  
Seldin # 1 R  
16 cm



**720/23**  
Seldin # 4 L  
16 cm



**720/24**  
Seldin # 4 R  
16 cm



**720/10**  
Flohr  
15,5 cm



**720/11**  
Flohr  
15,5 cm



**720/290**  
Apical Flohr  
# 4  
15,5 cm



**720/291**  
Apical Flohr  
# 5  
15,5 cm



**720/293**  
Apical Flohr  
# 81  
15,5 cm



**720/303**  
Apical Flohr  
# 46  
15 cm

## Dental



## Dental



**720/16**  
# 12  
15 cm



**720/33**  
Miller # 1  
15,5 cm



**720/34**  
Miller # 2  
15,5 cm



**720/35**  
Miller # 3  
15 cm



**720/36**  
Miller # 4  
15 cm



**720/73 A**  
Miller # 73  
15 cm



**720/74 A**  
Miller # 74  
15 cm



**720/63**  
Cogswell # A  
15 cm



**720/64**  
Cogswell # B  
15 cm



**720/73 B**  
15 cm



**720/74 B**  
15 cm



**720/295**  
University of Alabama  
15 cm



**720/300**  
Cameron  
15,5 cm



**720/77 R**  
Glogoff  
15,5 cm



**720/251**  
Lindo-Levien  
15 cm



# MULTICRAFTS Corporation



**720/14**  
#3 A Cryer  
15,5 cm



**720/27**  
# 27 Cryer  
16 cm



**720/28**  
# 28 Cryer  
16 cm



**720/27 S**  
# 27 S Cryer  
16 cm



**720/28 S**  
# 28 S Cryer  
16 cm



**720/284**  
# 1 Cryer  
15 cm



**720/285**  
# 2 Cryer  
15 cm



**720/286**  
# 31 Cryer  
15 cm



**720/287**  
# 32 Cryer  
15 cm



**720/288**  
# 39 Cryer  
15,5 cm



**720/289**  
# 40 Cryer  
15,5 cm



**720/280**  
15 cm



**720/281**  
15 cm



**720/305**  
# 71  
15,5 cm



**720/306**  
# 72  
15,5 cm

Dental



# MULTICRAFTS Corporation

## Dental



**720/34 SA**  
15 cm



**720/46**  
15 cm



**720/46 R**  
15 cm



**720/57**  
14,5 cm



**720/58 #0**  
15 cm



**720/59 #1**  
15 cm



**720/61**  
15 cm



**720/80**  
15 cm



**720/97**  
15 cm



**720/98**  
15 cm



**720/100**  
16 cm



**720/252 #46 R**  
15 cm  
gerieft  
serrated  
striée  
estriado  
zigrinate



**720/266 #11 A**  
15 cm



**720/313 #77 R**  
15 cm  
gerieft  
serrated  
striée  
estriado  
zigrinate

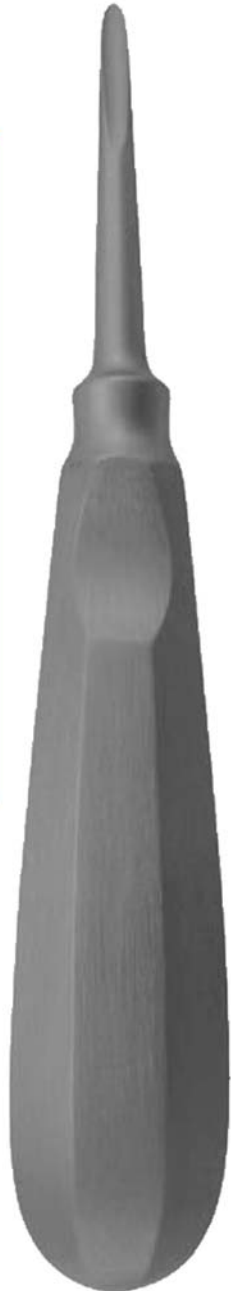

**92**  
Luxator  
3,5 mm  
15 cm

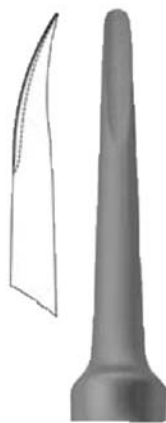

**93**  
Luxator  
3,5 mm  
15 cm

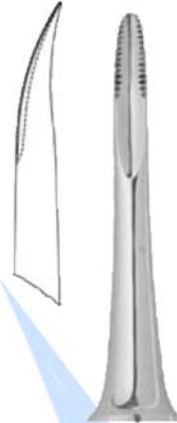

**93 Z**  
Luxator  
3,5 mm  
15 cm

gezahnt  
saw edge  
dentelés  
dentadas  
dentate



**95**  
Luxator  
4,5 mm  
15 cm

### Luxator

Instrumente zum Durchtrennen der zahnfixierenden Ligamente. Die sehr flache und scharfkantige Form der Arbeitsenden erlaubt ein schonendes Eindringen in den Parodontalspalt. Hier wird der Luxator in ausschließlich rotierender und schneidender Bewegung eingesetzt und dadurch die Alveole schonend erweitert.

Das traditionelle horizontale Aushebeln birgt hohe Bruchgefahr. Ein vertikales Aushebeln ist mit den traditionellen Hebeln nur bedingt möglich. So ist mit der Konstruktion der Luxatoren eine nahezu ideale Synthese zwischen traditionellem Hebel und Periostom gelungen. Unterstützend wirkt vor allem die negative Krümmung.

### Luxators

Dental instrument to sever tooth-fixed ligaments. The extremely flat and sharp edged form of the working ends allows a very gentle penetration into the periodontal gap. Here, the luxator is used only in a rotating and cutting manner and allows a very gentle widening of the alveole.

### Luxateurs

Le Luxateur est un instrument destiné à l'extraction par une technique de séparation des tissus et de la dent qui a la même fonction qu'un élévateur. Cet instrument possède une lame extra-plate et tranchante de manière à sectionner les ligaments.

Par des mouvements de rotations et de coupe il mobilise la dent à l'inverse de l'élévateur qui élève, mobilise et sert de levier. L'avantage du Luxateur est, qu'il diminue les traumatismes exercés sur la dent et les tissus adjacents.



# MULTICRAFTS Corporation



**792/11**  
Beck  
18,5 cm

gezahnt  
saw edge  
denteles  
dentadas  
dentate



**792/1**  
Heidbrink  
19,5 cm



**792/2**  
Heidbrink  
19,5 cm



**792/3**  
Heidbrink  
19,5 cm



**792/4**  
Heidbrink  
19,5 cm

gezahnt  
saw edge  
denteles  
dentadas  
dentate



**792/5**  
Heidbrink  
19,5 cm

gezahnt  
saw edge  
denteles  
dentadas  
dentate



**792/6**  
Heidbrink  
19,5 cm

gezahnt  
saw edge  
denteles  
dentadas  
dentate



**47 PF**  
19 cm



**48 PF**  
19 cm



**792/10**  
Beck  
18,5 cm

gezahnt  
saw edge  
denteles  
dentadas  
dentate

# Dental



## Dental



**793/AS 1**  
13,5 cm



**793/AS 3**  
Heidbrink  
13,5 cm



**793/AS 2**  
Heidbrink  
13,5 cm



**793/AS 1N**  
Heidbrink  
13 cm



**793/AS 3N**  
Heidbrink  
13,5 cm



**793/AS 2N**  
Heidbrink  
13,5 cm



**794/332**  
Howard-Apexo  
# 2  
14,5 cm



**794/334**  
Howard-Apexo  
# 3  
14,5 cm



**794/333**  
Howard-Apexo  
# 1  
15 cm



**794/340**  
Heidbrink  
# 2  
14,5 cm



**794/342**  
Heidbrink  
# 3  
14,5 cm



**794/341**  
Heidbrink  
# 1  
14,5 cm



**795/327**  
Warwick-James  
# 2  
15,5 cm



**795/329**  
Warwick-James  
# 3  
15,5 cm



**795/328**  
Warwick-James  
# 1  
16 cm



**1291/202**  
# 1 / 3652  
19 cm



**1291/203**  
# 2 / 3662  
17,5 cm



**794 / 5 A**  
Davis # 10  
21 cm



**794 / 5 B**  
Davis # 11  
21 cm



**794 / 7 S**  
Seldin  
19,5 cm



**794 / 200**  
Davis  
20 cm

## Dental





## Dental



**792/7**  
19,5 cm

gezahnt  
saw edge  
denteles  
dentadas  
dentate



**794/323**  
Davis # 1  
18,5 cm

Achtkantgriff / gerieft  
Octagonal handle / serrated  
Manche octogonal / striée  
Mango octagonal / estriado  
Manico ottagonale / zigrinate



**794/322**  
Davis # 2  
18,5 cm



**794/324**  
Davis # 3  
18,5 cm



**794/337**  
West # 1  
16,5 cm

Achtkantgriff / glatt  
Octagonal handle / smooth  
Manche octogonal / lisse  
Mango octagonal / lisa  
Manico ottagonale / lisce



**794/336**  
West # 2  
17 cm



**794/338**  
West # 3  
17 cm



# MULTICRAFTS Corporation

# Dental



**796/2**  
Chompret  
16,5 cm

Hohlgriff  
Hollow Handle  
Poignée creuse  
Mango hueco  
Manico cavo



**796/3**  
Chompret  
16,5 cm

Hohlgriff  
Hollow Handle  
Poignée creuse  
Mango hueco  
Manico cavo



**796/1M**  
16 cm

Griff massiv  
Handle solid  
Manche massive  
Mango sólido  
Manico solida



**796/7S**  
15,5 cm

Griff massiv  
Handle solid  
Manche massive  
Mango sólido  
Manico solida



**796/8**  
15,5 cm

Griff massiv  
Handle solid  
Manche massive  
Mango sólido  
Manico solida



1/2

**796/7**  
17 cm

Griff massiv  
Handle solid  
Manche massive  
Mango sólido  
Manico solida



1/2

**796/7 A**  
17 cm



1/2

**796/17**  
17 cm

Griff massiv  
Handle solid  
Manche massive  
Mango sólido  
Manico solida



gezahnt  
saw edge  
dentelés  
dentadas  
dentate



1/2

**796/17 A**  
17 cm

**796/1**  
Chompret  
16,5 cm

Hohlgriff  
Hollow Handle  
Poignée creuse  
Mango hueco  
Manico cavo



**Dental**



**798 / 1**  
Morrison  
Ø 3,5 mm  
11,5 cm

**798 / 2**  
Morrison  
Ø 3 mm  
11,5 cm



**798 / 5**  
Carroll-Girard  
10 cm



# MULTICRAFTS Corporation

All in \*1)  
 komplett mit Art No.  
 complete with Art No.  
 complet avec Art No.  
 completo con Art No.  
 completo di Art No.

2595 A, 2595 B, 2595 C, 2595 / 1 G, 2595 / 1 S, 2595 / 1 ST  
 2595 A, 2595 B, 2595 C, 2595 / 1 G, 2595 / 1 S, 2595 / 1 ST  
 2595 A, 2595 B, 2595 C, 2595 / 1 G, 2595 / 1 S, 2595 / 1 ST  
 2595 A, 2595 B, 2595 C, 2595 / 1 G, 2595 / 1 S, 2595 / 1 ST  
 2595 A, 2595 B, 2595 C, 2595 / 1 G, 2595 / 1 S, 2595 / 1 ST

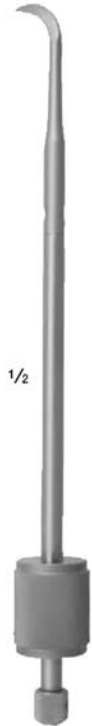

**2595/1**  
 All in \*1)  
 21 cm



**2595 A**  
 Single  
 8 cm



**2595 B**  
 Single  
 8 cm



**2595 C**  
 Single  
 8 cm

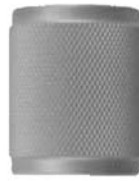

**2595/1 G**  
 Single  
 2,7 cm



**2595/1 S**  
 Single  
 14,3 cm



**2595/1 ST**  
 Single  
 4 cm

All in \*2)  
 komplett mit Art No.  
 complete with Art No.  
 complet avec Art No.  
 completo con Art No.  
 completo di Art No.

2595 A, 2595 B, 2595 C, 2595 / 2 G, 2595 / 2 S, 2595 / 1 ST  
 2595 A, 2595 B, 2595 C, 2595 / 2 G, 2595 / 2 S, 2595 / 1 ST  
 2595 A, 2595 B, 2595 C, 2595 / 2 G, 2595 / 2 S, 2595 / 1 ST  
 2595 A, 2595 B, 2595 C, 2595 / 2 G, 2595 / 2 S, 2595 / 1 ST  
 2595 A, 2595 B, 2595 C, 2595 / 2 G, 2595 / 2 S, 2595 / 1 ST

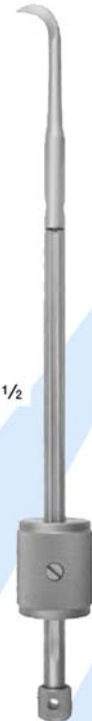

**2595/2**  
 All in \*2)  
 21 cm



**2595 A**  
 Single  
 8 cm



**2595 B**  
 Single  
 8 cm



**2595 C**  
 Single  
 8 cm



**2595/2 G**  
 Single  
 2,7 cm



**2595/2 S**  
 Single  
 14 cm



**2595/1 ST**  
 Single  
 4 cm

# Dental



# MULTICRAFTS Corporation

## Dental



All in \*3)  
 komplett mit Art No. 2595 / 4 A, 2595 / 4 B, 2595 / 4 C, 2595 / 2 G, 2595 / 2 S, 2595 / 1 ST  
 complete with Art No. 2595 / 4 A, 2595 / 4 B, 2595 / 4 C, 2595 / 2 G, 2595 / 2 S, 2595 / 1 ST  
 complet avec Art No. 2595 / 4 A, 2595 / 4 B, 2595 / 4 C, 2595 / 2 G, 2595 / 2 S, 2595 / 1 ST  
 completo con Art No. 2595 / 4 A, 2595 / 4 B, 2595 / 4 C, 2595 / 2 G, 2595 / 2 S, 2595 / 1 ST  
 completo di Art No. 2595 / 4 A, 2595 / 4 B, 2595 / 4 C, 2595 / 2 G, 2595 / 2 S, 2595 / 1 ST



**2595/6**  
All in \*4)

All in \*4)  
 komplett mit Art No. 2595 / 7, 2595 / 1 G, 2595 / 1 S  
 complete with Art No. 2595 / 7, 2595 / 1 G, 2595 / 1 S  
 complet avec Art No. 2595 / 7, 2595 / 1 G, 2595 / 1 S  
 completo con Art No. 2595 / 7, 2595 / 1 G, 2595 / 1 S  
 completo di Art No. 2595 / 7, 2595 / 1 G, 2595 / 1 S

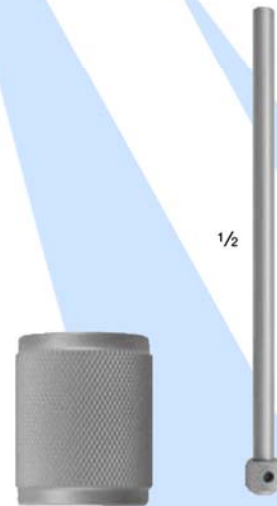



## Dental

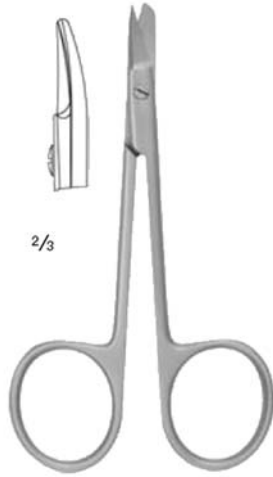

2/3

**32 K**  
9,5 cm

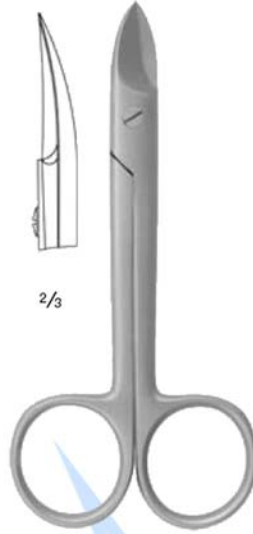

2/3

**2610/2**  
Beebee  
10,5 cm

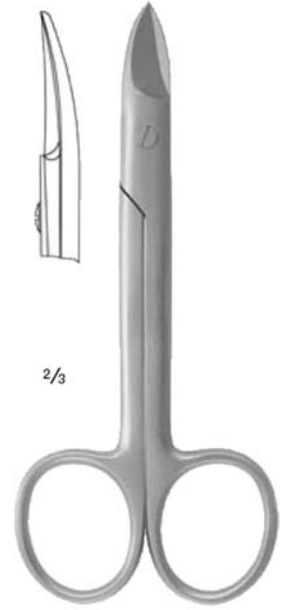

2/3

**2620/2**  
Beebee  
12 cm

gezahnt  
saw edge  
dentelés  
dentadas  
dentate

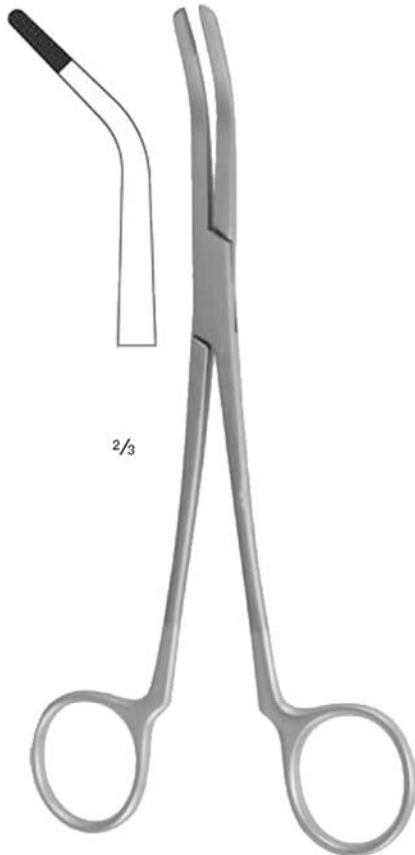

2/3

**2594 TC**  
Wynmann  
17 cm



2/3

**2684**  
Baade  
15 cm



2/3

**2685**  
Baade  
16 cm

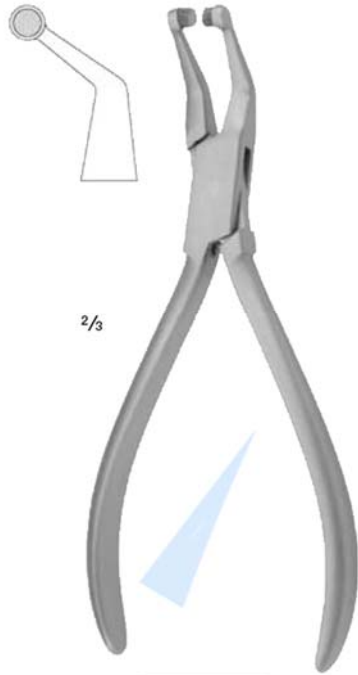

2706  
14 cm

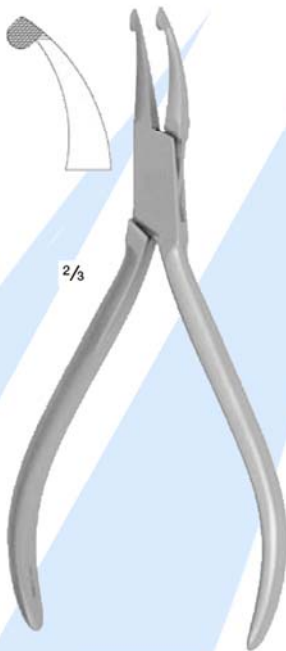

2700  
How  
13,5 cm

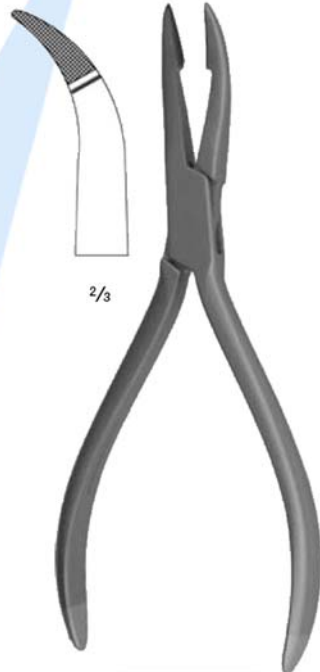

2707 TC  
Weingart  
14,5 cm

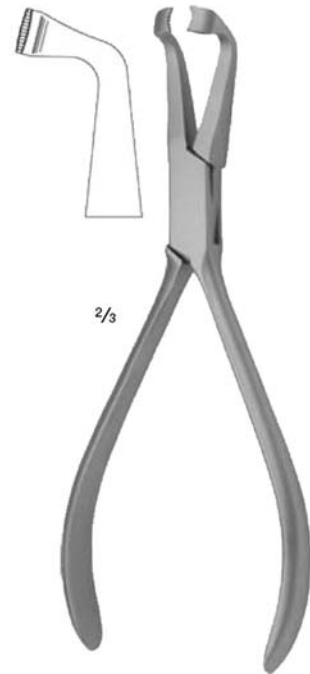

2708  
Dr. Krause-Hohenstein  
14,5 cm

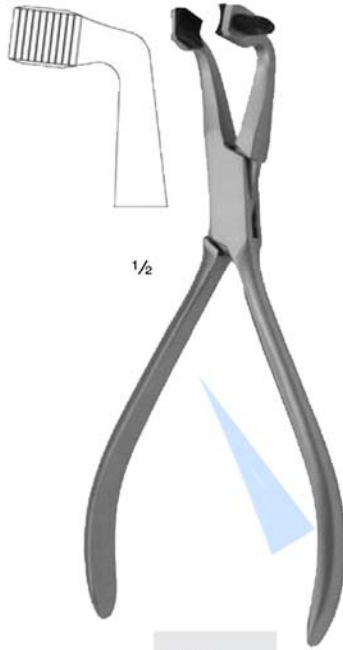

1/2

**2693**  
Gum insert  
for Art No 2709

Gummeinsatz für	Art No 2709 (1 pcs)
Gum insert for for	Art No 2709 (1 pcs)
Embout caoutchouc pour	Art No 2709 (1 pcs)
Punta caucho para	Art No 2709 (1 pcs)
Tassello di gomma per	Art No 2709 (1 pcs)

**2709**  
14 cm

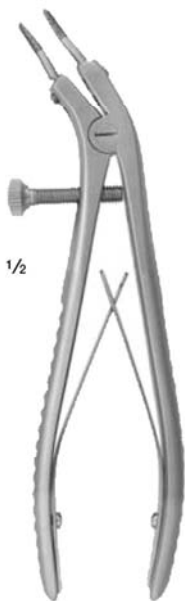

1/2

**2746/1**  
13 cm



1/2

**2746/2**  
12,5 cm



1/2

**2746/3**  
12,5 cm



**2746/4**



**2746/5**



Teleskopkronenzange mit auswechselbaren  
Diamant-Einsätzen

Telescopic crown pliers with exchangeable  
diamond inserts

Pince télescopique à couronnes avec inserts en  
diamant interchangeables

Alicates telescópicos para coronas con piezas  
de inserción de diamante intercambiables

Pinzette telescopiche per corona con inserti in  
diamante intercambiabili

Ersatzspitzen  
Replacement tips  
Pointes de rechange  
Puntas de recambio  
Coppia di punte di ricambio





1/2



**2815**  
Universal  
16 cm

Universal Kramponzange  
Universal pliers  
Pincers universelles  
Alicates universales  
Tenaglie universali



1/2

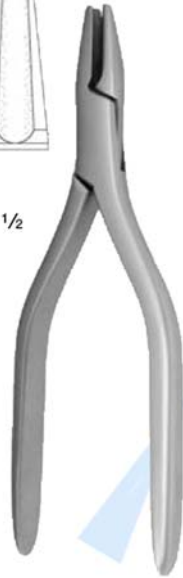

**2885**  
Mc Kellops  
16,0 cm

Bügelbiegezange  
Bar bending pliers  
Pincers à plier les barres  
Alicates para doblar barras  
Pinze per barre e fili



1/2

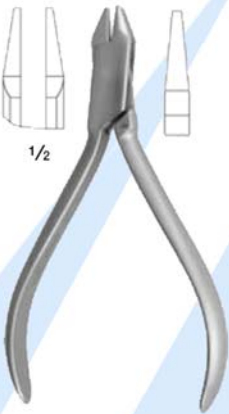

**2865**  
Aderer  
11,5 cm

Drathbiegezange  
Wire bending pliers  
Pincers à courber les fils  
Alicates para doblar alambre  
Pinze per piegare fili



**2870**  
Aderer  
13 cm



1/2

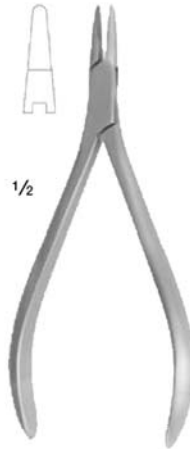

**3006 TC**  
11,5 cm

Knochenplattenbiegezange  
Bending plier for plates  
Pince à courber plauques  
Alicates para ortodoncia y protesis



1/2

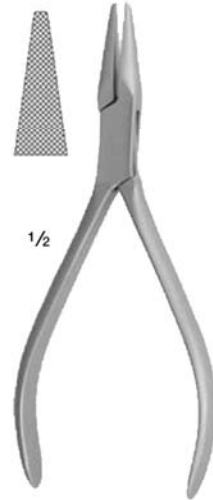

**3060**  
14 cm

Flachzange  
Flat nose plier  
Pincers plates  
Alicates de picos chatos  
Pinze a punte piatte



1/2

für weiche Drähte bis  
for soft wires up to  
pour fils mous jusqu'à  
para alambres blandos hasta  
per fili molli fino a  
Ø 2,3 mm

für harte Drähte bis  
for hard wires up to  
pour fils durs jusqu'à  
para alambres duros hasta  
per fili metallici duri fino a  
Ø 1,5 mm

**3080**

14,0 cm

Seitenschneider  
Wire cutter  
Pince coupante  
Alicates para cortar alambre  
Pinze per troncare fili

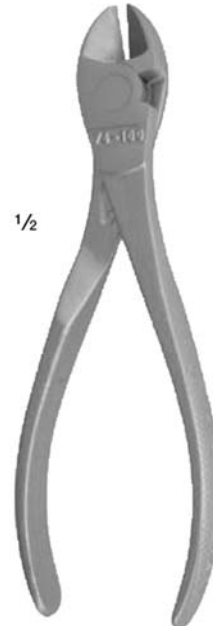

1/2

für weiche Drähte bis  
for soft wires up to  
pour fils mous jusqu'à  
para alambres blandos hasta  
per fili molli fino a  
Ø 2,8 mm

für harte Drähte bis  
for hard wires up to  
pour fils durs jusqu'à  
para alambres duros hasta  
per fili metallici duri fino a  
Ø 2,0 mm

**3095**

16,5 cm

Seitenschneider  
Wire cutter  
Pince coupante  
Alicates para cortar alambre  
Pinze per troncare fili

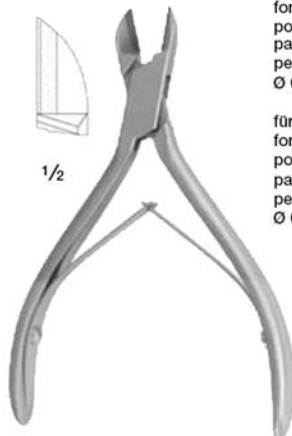

1/2

für weiche Drähte bis  
for soft wires up to  
pour fils mous jusqu'à  
para alambres blandos hasta  
per fili molli fino a  
Ø 0,7 mm

für harte Drähte bis  
for hard wires up to  
pour fils durs jusqu'à  
para alambres duros hasta  
per fili metallici duri fino a  
Ø 0,5 mm

**3105 TC**

11,5 cm

Seitenschneider  
Wire cutter  
Pince coupante  
Alicates para cortar alambre  
Pinze per troncare fili

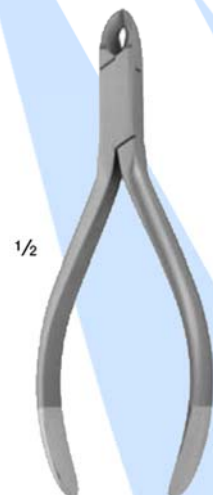

1/2

für weiche Drähte bis  
for soft wires up to  
pour fils mous jusqu'à  
para alambres blandos hasta  
per fili molli fino a  
Ø 0,6 mm

für harte Drähte bis  
for hard wires up to  
pour fils durs jusqu'à  
para alambres duros hasta  
per fili metallici duri fino a  
Ø 0,4 mm

**3110 TC**

13,0 cm

Drahtschneidezangen  
Wire cutter  
Pince coupante  
Alicates para cortar alambre  
Pinze per troncare fili



1/2

für weiche Drähte bis  
for soft wires up to  
pour fils mous jusqu'à  
para alambres blandos hasta  
per fili molli fino a  
Ø 1,3 mm

für harte Drähte bis  
for hard wires up to  
pour fils durs jusqu'à  
para alambres duros hasta  
per fili metallici duri fino a  
Ø 1,0 mm

**3120 TC**

14,5 cm

Kopfschneider  
Wire cutter, front action  
Pincès coupantes frontales  
Alicates frontal para cortar alambre  
Tenaglie tagliafili frontali

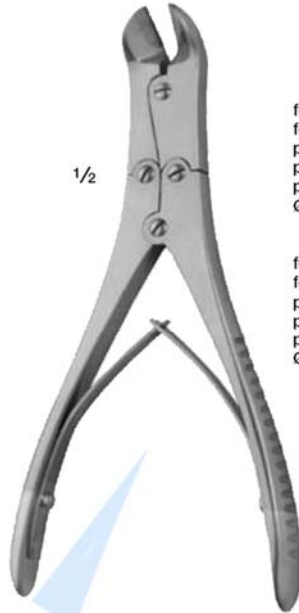

1/2

für weiche Drähte bis  
for soft wires up to  
pour fils mous jusqu'à  
para alambres blandos hasta  
per fili molli fino a  
Ø 2,0 mm

für harte Drähte bis  
for hard wires up to  
pour fils durs jusqu'à  
para alambres duros hasta  
per fili metallici duri fino a  
Ø 1,6 mm

**3130 TC**

16 cm

Drahtschneidezange  
Wire cutter  
Pince coupante  
Alicates para cortar alambre  
Pinze per troncare fili



1/2

**2200 / 1**  
Fahnenstock  
12,5 cm



1/2

**2200 / 2**  
Fahnenstock  
18 cm



1/2

**2210 / 1**  
Lessmann  
13 cm



1/2

**2210 / 2**  
Lessmann  
17,5 cm

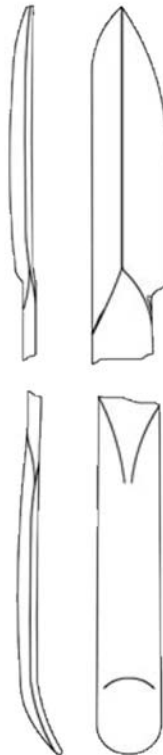



## Dental

1/3



**1159-1**  
Manicure Set, black  
20 cm x 15 cm

1/3

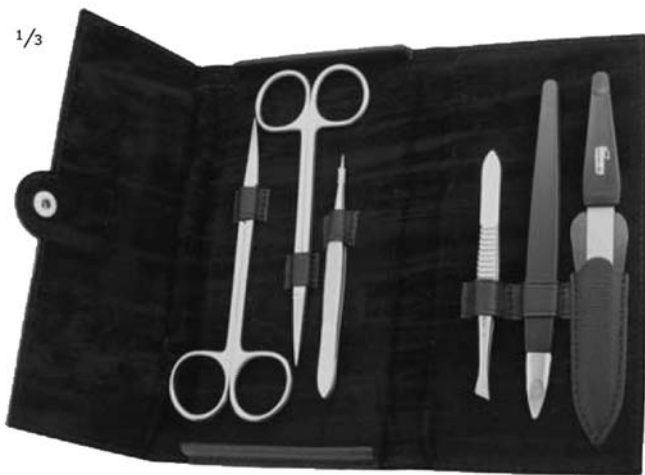

**1159**  
Manicure Set, black  
20 cm x 15 cm

2/3



**1155-7**  
9 cm

2/3



**1155-8**  
Lefthander  
9 cm