

# Multicrafts Corporation

Kotli Behram, Khadim Ali Road  
P.O. Box 949, Sialkot 51310 Pakistan  
Tel: +92 52 426 4892  
Fax: +92 52 426 4692

@: info@multicrafts.com.pk  
<http://www.multicrafts.com.pk>



**NEURO SPINAL  
SURGERY INSTRUMENTS**



**Multicrafts Corporation**



# MULTICRAFTS Corporation

## SURGICAL INSTRUMENTS



1/2  
TAYLOR  
16 cm/6 1/4"

spitzes Ende  
pointed end  
pointe aigüe  
punta aguda  
punta acuta

Knochenhebel  
Bone Levers  
Leviers à os  
Elevadores para hueso  
Elevatori per ossa

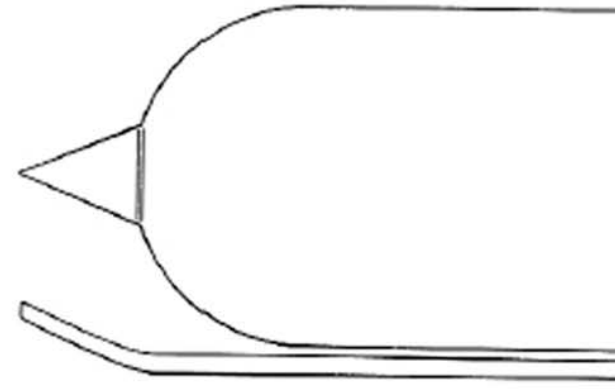

32.831.16  
75 x 30 mm

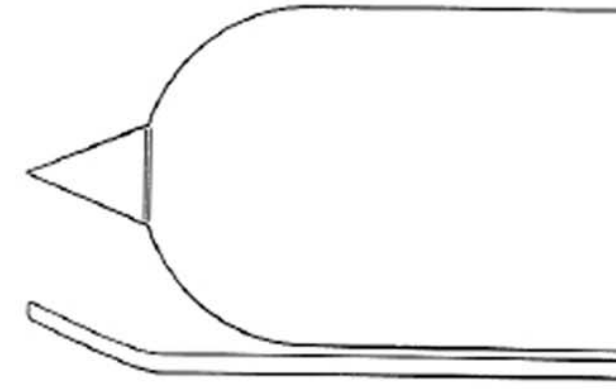

32.833.16  
100 x 30 mm

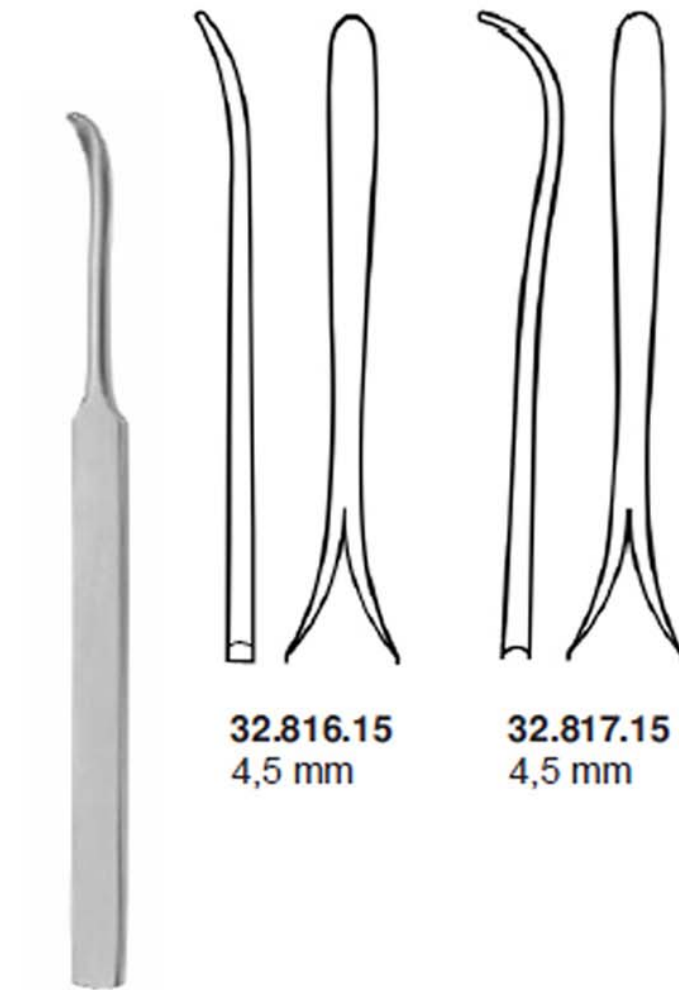

1/2  
KOENIG  
15 cm/6"

32.816.15  
4,5 mm

32.817.15  
4,5 mm

Sehnenfaßzange  
Tendon grasping forceps  
Pince pour saisir les tendons  
Pinza para agarrar tendones  
Pinze da presa per tendini



1/2  
CARROL  
32.959.11  
11 cm/4 1/2"

# Neuro Spinal



## SURGICAL INSTRUMENTS



**33.210.95**  
Handbohrapparate allein  
Hand Drill only  
Perforateurs à main seul  
Perforadores de mano suelto  
Perforatori a mano solo

STILLE  
20,5 cm/8"

**33.210.20**  
Komplett mit 9 Bohrem/Fräsem  
complete with 9 twist drills/burrs  
complete avec 9 fraises  
completo con 9 brocas  
completo con 9 punte  
33.212.25 - 33.214.16

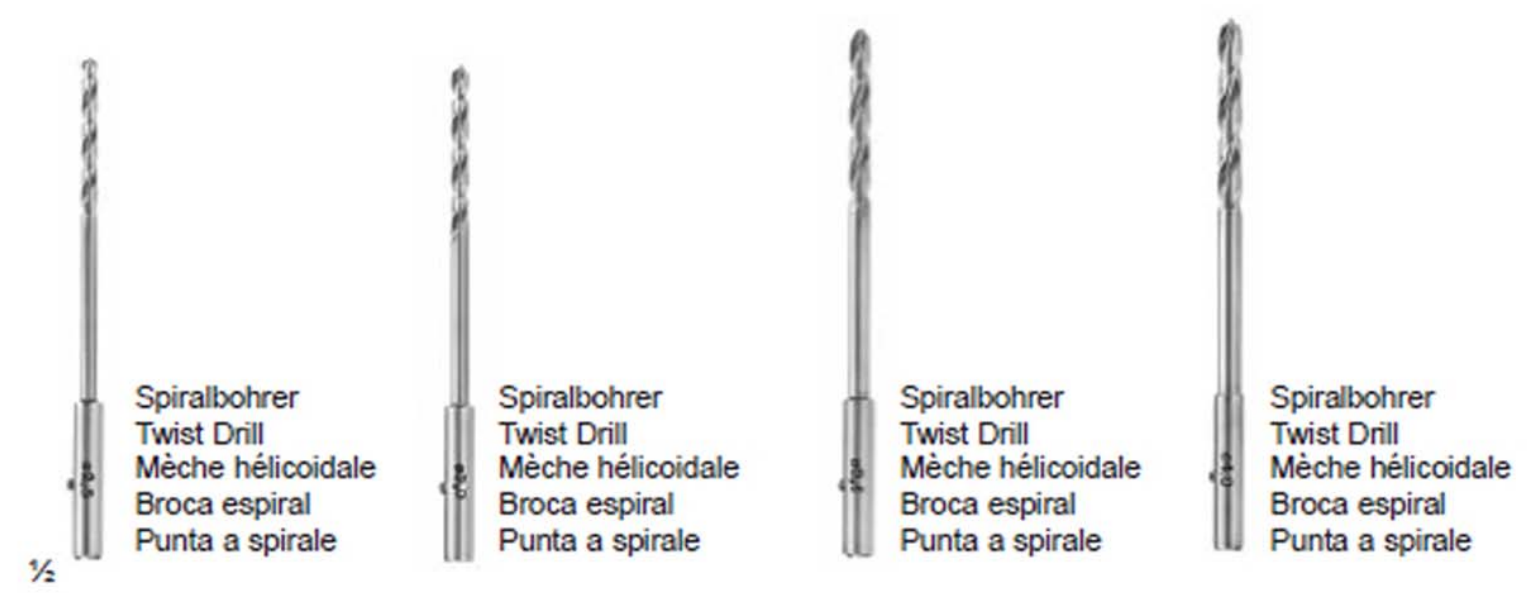

1/2	1/2	1/2	1/2
<b>33.212.25</b> Ø 2,5 mm Fig. 1	<b>33.212.30</b> Ø 3,0 mm Fig. 2	<b>33.212.35</b> Ø 3,5 mm Fig. 3	<b>33.212.40</b> Ø 4,0 mm Fig. 4

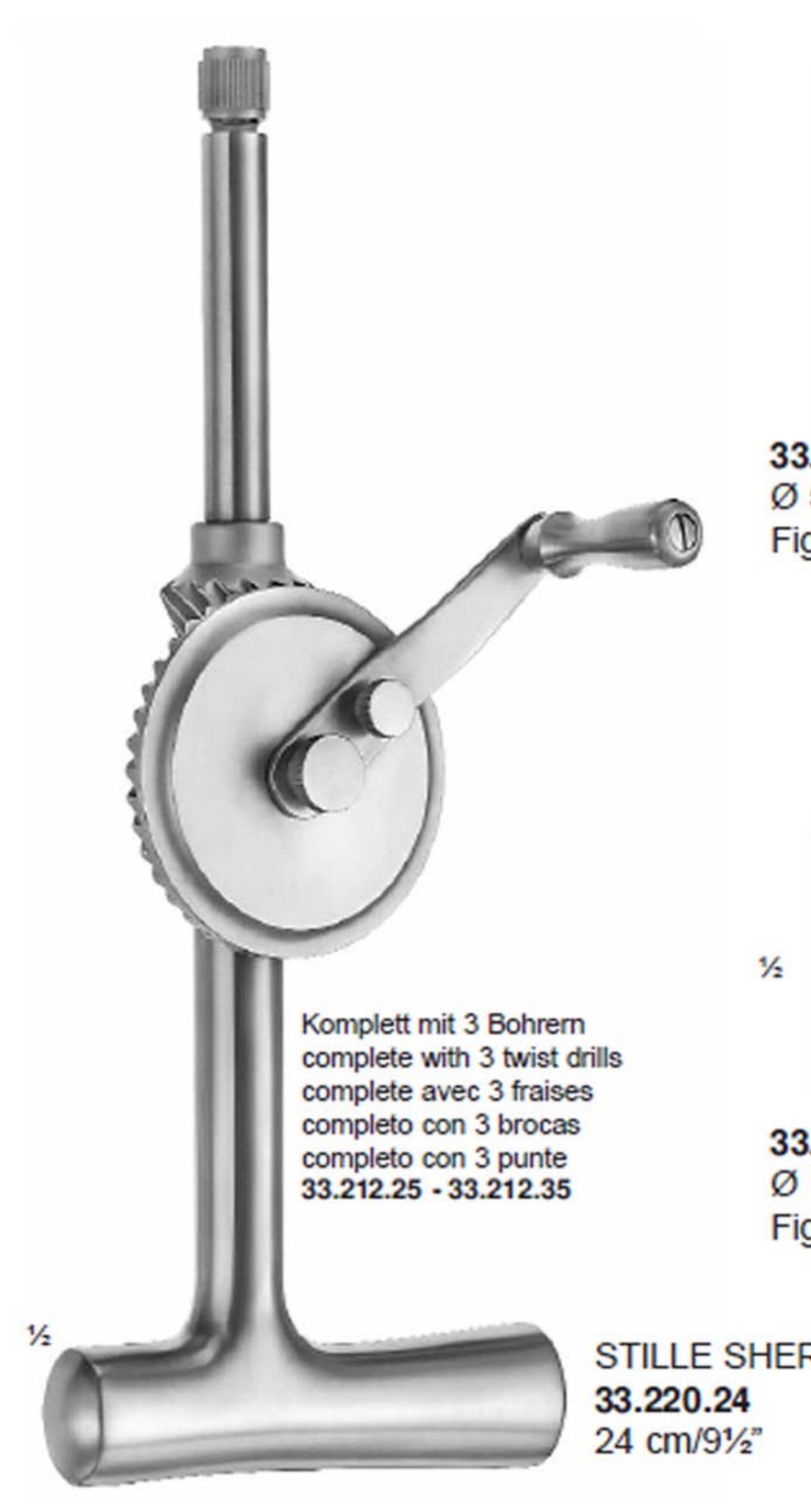

Komplett mit 3 Bohrem  
complete with 3 twist drills  
complete avec 3 fraises  
completo con 3 brocas  
completo con 3 punte  
33.212.25 - 33.212.35

STILLE SHERMAN  
**33.220.24**  
24 cm/9 1/2"



1/2	1/2	1/2	1/2
<b>33.214.05</b> Ø 5,0 mm Fig. 6	<b>33.214.08</b> Ø 8,0 mm Fig. 7	<b>33.214.12</b> Ø 12 mm Fig. 8	<b>33.214.16</b> Ø 16 mm Fig. 9

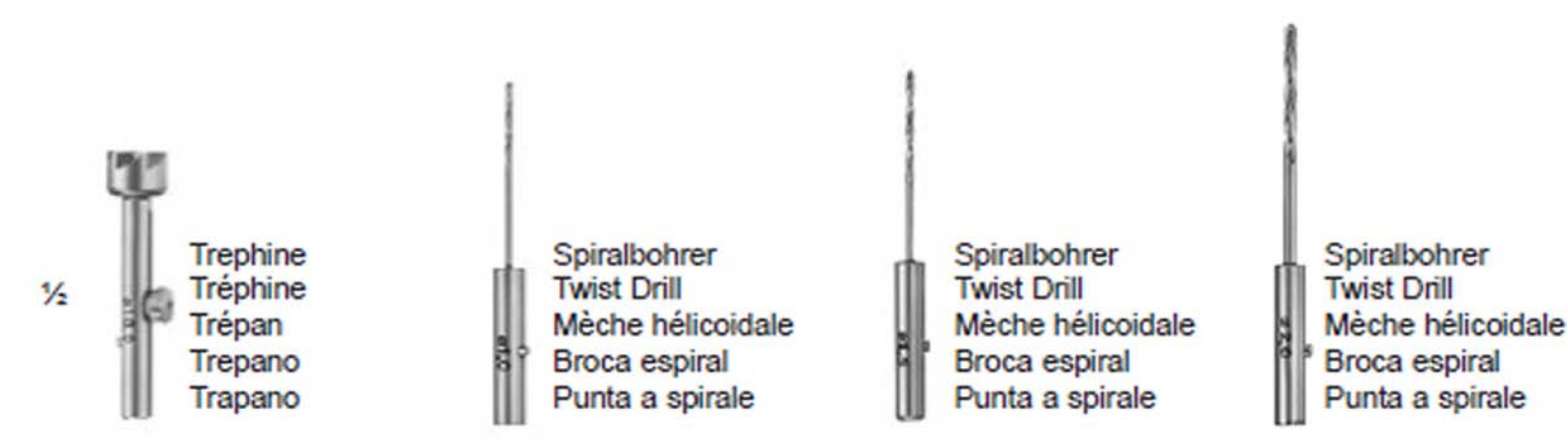

1/2	1/2	1/2	1/2
<b>33.214.10</b> Ø 10 mm Fig. 5	<b>33.216.10</b> Ø 1,0 mm Fig. 10	<b>33.216.15</b> Ø 1,5 mm Fig. 11	<b>33.216.20</b> Ø 2,0 mm Fig. 12



# MULTICRAFTS Corporation



**33.240.27**  
 komplett, mit Fräsern Fig. 1 - 4 33.242.09 - 33.242.22  
 und Verlängerungsstück 33.246.00  
 complete, with burrs no. 1 - 4 33.242.09 - 33.242.22  
 and extension piece 33.246.00  
 complet, avec fraises no. 1 - 4 33.242.09 - 33.242.22 et  
 pièce de rallonge 33.246.00  
 completo, con fresas no. 1 - 4 33.242.09 - 33.242.22 y  
 pieza de extensión 33.246.00  
 completo, con frese fig. 1 - 4 33.242.09 - 33.242.22 e  
 giunto di prolungamento 33.246.00



Kegelfräser  
 Conical Burr  
 Fraise conique  
 Fresa cónica  
 Fresa cuneiforme  
**33.242.09**  
 Ø 9 mm  
 Fig. 1



Kegelfräser  
 Conical Burr  
 Fraise conique  
 Fresa cónica  
 Fresa cuneiforme  
**33.242.14**  
 Ø 14 mm  
 Fig. 2



Kugelfräser  
 Spherical Burr  
 Fraise spherique  
 Fresa esférica  
 Fresa sferica  
**33.242.16**  
 Ø 16 mm  
 Fig. 3



Kugelfräser  
 Spherical Burr  
 Fraise spherique  
 Fresa esférica  
 Fresa sferica  
**33.242.22**  
 Ø 22 mm  
 Fig. 4



Flachbohrer  
 Flat Trephine  
 Fraise plate  
 Taladro plano  
 Trapano piatto  
 CUSHING  
**33.244.14**  
 Ø 14 mm  
 Fig. 5



Spiralbohrer  
 Twist Drill  
 Mèche hélicoïdale  
 Broca espiral  
 Punta a spirale  
**33.245.00**  
 Ø 2,0 mm  
 Fig. 6



Bohrer  
 Burr  
 Fraise  
 Fresa  
 Punta  
 MCKENZIE  
**33.248.00**  
 Fig. 7



Bohrer  
 Burr  
 Fraise  
 Fresa  
 Punta  
 D'ERRICO  
**33.249.00**  
 16 mm  
 Fig. 8

Verlängerungsstück  
 Extension piece  
 Pièce de rallonge  
 Pieza de prolongación  
 Giunto di prolungamento



**33.246.00**



**33.246.01**

# Neuro Spinal



# MULTICRAFTS Corporation

## SURGICAL INSTRUMENTS

Hirnaht  
Brain Suture  
Sutura cerebral  
Suture cérébrale  
Sutura cerebrale

# Neuro Spinal



**McKENZIE**  
15 cm/6" **40.011.15**  
19 cm/7½" **40.011.19**



**McKENZIE**  
15 cm/6" **40.013.15**  
19 cm/7½" **40.013.19**



**SMITHWICK**  
23 cm/9" **40.015.23**  
26 cm/10¼" **40.015.26**



**SWEET**  
23 cm/9" **40.017.23**  
26 cm/10¼" **40.017.26**

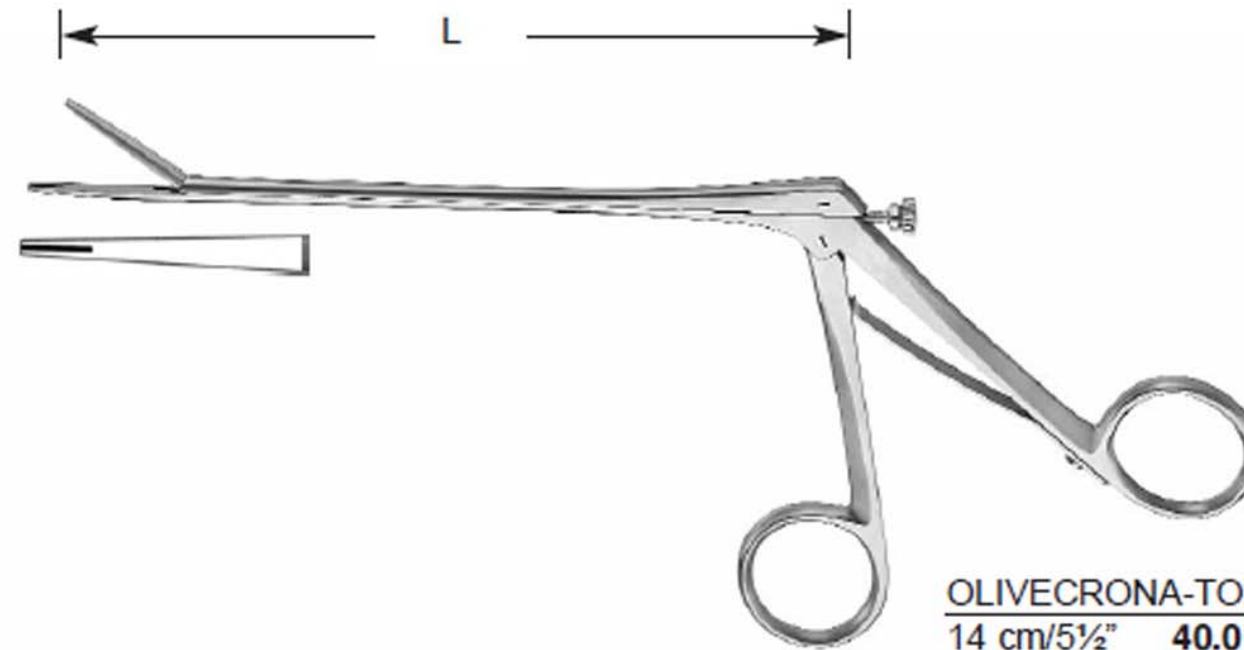

**OLIVECRONA-TOENNIS**  
14 cm/5½" **40.019.14**  
20 cm/8" **40.019.20**



# MULTICRAFTS Corporation

SURGICAL INSTRUMENTS



McKENZIE  
40.020.00  
148 x 40 x 6 mm

Klammernblock, mit 1 Klammernbügel  
Brain Clip Carrier, with 1 clip holding  
Support porte-agrafes, simple, à 1 rangée d'agrafes et couvercle à glissière  
Porta-grapas, con 1 reil para grapas  
Support metallico, semplice, con porta-fermagli e corperchio scorrevole



McKENZIE  
40.020.02  
190 x 48 x 13 mm

Klammernblock, mit 2 Klammernbügel  
Brain Clip Carrier, with 2 clip holding  
Support porte-agrafes, simple, à 2 rangée d'agrafes et couvercle à glissière  
Porta-grapas, con 2 reil para grapas  
Support metallico, semplice, con 2 porta-fermagli e corperchio scorrevole



40.022.00

Kölner Spar Klammer, zu 100 Stück  
Kölner clip reusable, comprising 100 pieces  
Cologne agrafe économique, Boîtes de 100 pièces  
grapa economica Colonia, conteniendo 100 piezas  
agrafe economica mod. Cologna, Unità di 100 pezzi



RANEY  
40.027.00

Kopfhautklammer  
Scalp Hemostasis Clip  
Agrafes hémostatique pour cuir chevelu  
Pinza hemostática para cuero cabelludo  
Clip emostatici per cuoio capelluto



40.021.00

Silberklammern in Plastikbehälter, zu 100 Stück  
Silver Brain Clips in plastic vial, comprising 100 pieces  
Agrafes en argent pur, Boîtes de 100 pièces  
Grapas de plata en tubo de plástico, conteniendo 100 piezas  
Fermagli d'argento, Unità di 100 pezzi



RANEY  
40.028.00  
15,5 cm/6¼"

Anlege-und Abnehme-Zange für Kopfhautklammern  
Applying and Removing Forceps for Scalp Hemostasis Clips  
Pine pour poser et retirer les clips hémostatiques du cuir chevelu  
Pinza para aplicar y quitar clips hemostáticas de cuero cabelludo  
Pinza per applicare o togliere i clip emostatici al cuoio capelluto

Neuro Spinal



# MULTICRAFTS Corporation

SURGICAL INSTRUMENTS

## Neuro Spinal



**40.024.00**  
 großes Modell  
 large pattern  
 modèle grand  
 modelo grande  
 modello grande



**40.024.10**  
 Ersatzdom  
 Spare pin  
 Pointe de rechange  
 Espina de repuesto  
 Punta di ricambio

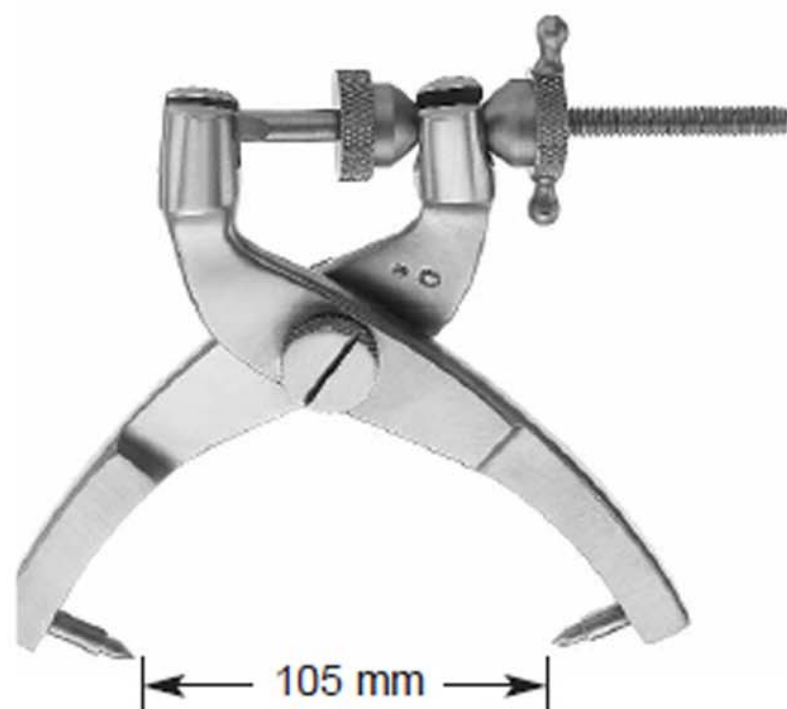

**CRUTCHFIELD 40.025.01**  
 kleines Modell  
 small pattern  
 modèle petit  
 modelo pequeño  
 modello piccolo



**CRUTCHFIELD 40.025.02**  
 mittleres Modell  
 medium pattern  
 modèle moyen  
 modelo mediano  
 modello medio



**CRUTCHFIELD 40.026.35**  
 7 cm/2<sup>3</sup>/<sub>4</sub>"  
 Ø 3,5 mm  
 Vorbohrer  
 Drill Point  
 Alésoir  
 Perforador  
 Alesatore



**CRUTCHFIELD 40.026.50**  
 7 cm/2<sup>3</sup>/<sub>4</sub>"  
 Ø 5,0 mm  
 Vorbohrer  
 Drill Point  
 Alésoir  
 Perforador  
 Alesatore



# MULTICRAFTS Corporation

## SURGICAL INSTRUMENTS

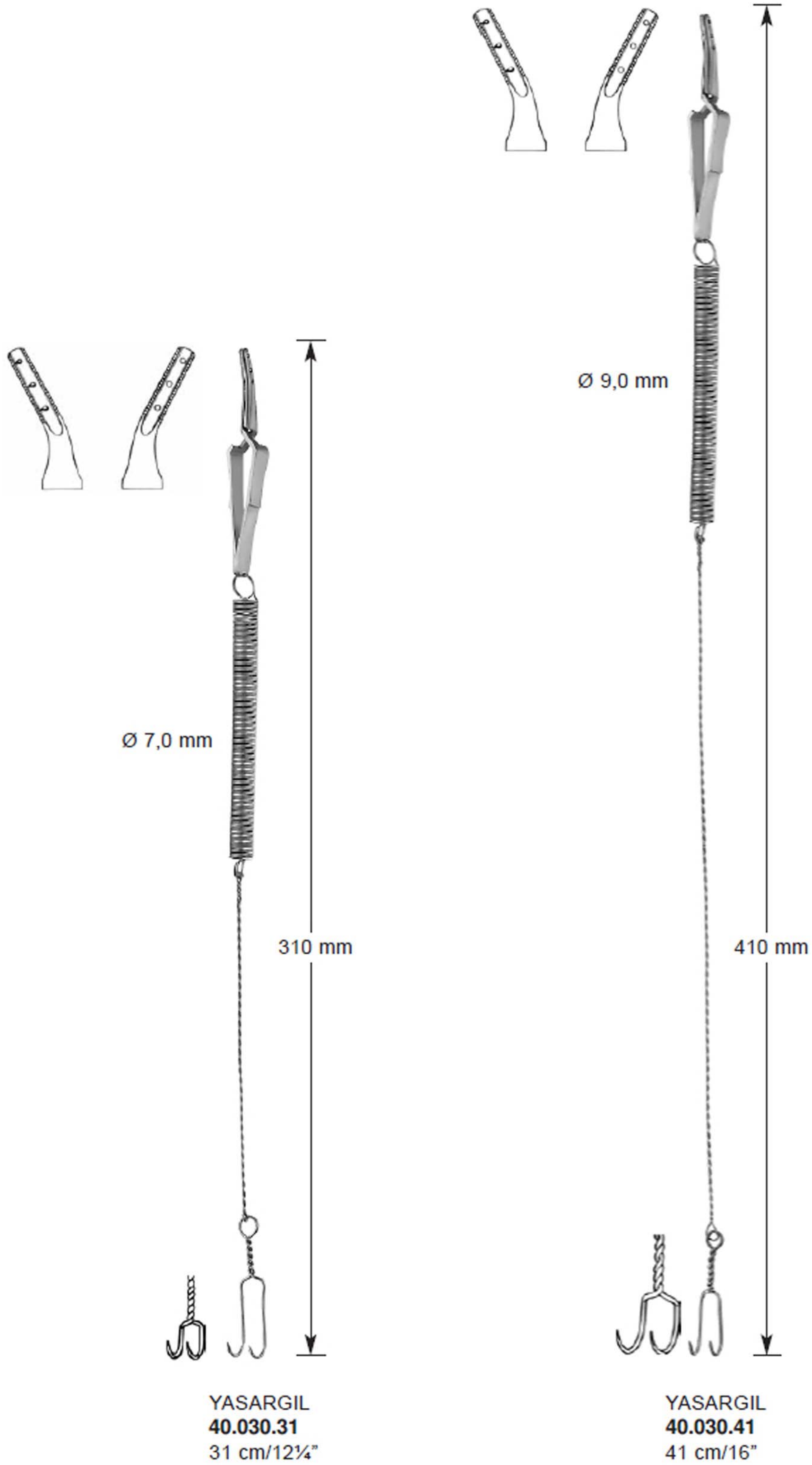

# Neuro Spinal





# MULTICRAFTS Corporation

## SURGICAL INSTRUMENTS

# Neuro Spinal

Einführinstrument  
Wire Saw Guide  
Conducteur pour fils-scies  
Conductor para sierras de hilo  
Introduttore



De MARTEL  
**40.090.33**  
33 cm/13"



LEBSCHER  
**40.091.25**  
25 cm/10"

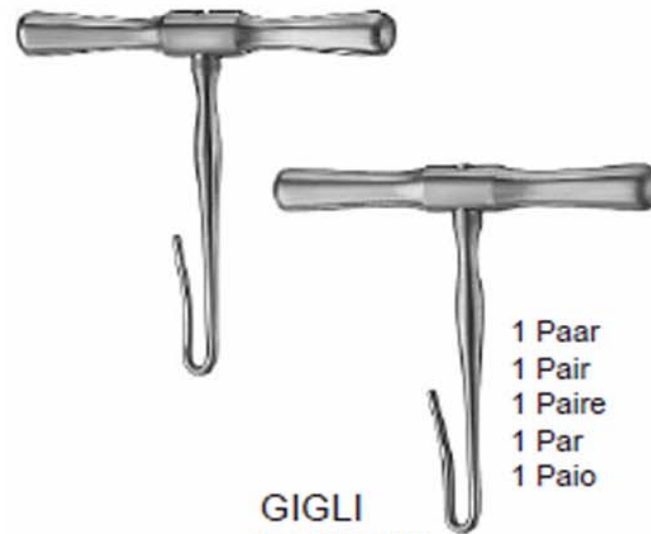

GIGLI  
**40.094.00**

2 x

1 Paar  
1 Pair  
1 Paire  
1 Par  
1 Paio



GIGLI  
**40.094.01**

3 x

1 Paar  
1 Pair  
1 Paire  
1 Par  
1 Paio

Drahtsägen-Handgriff  
Wire Saw Handle  
Manche à crochet  
Mango de gancho  
Manico con uncino

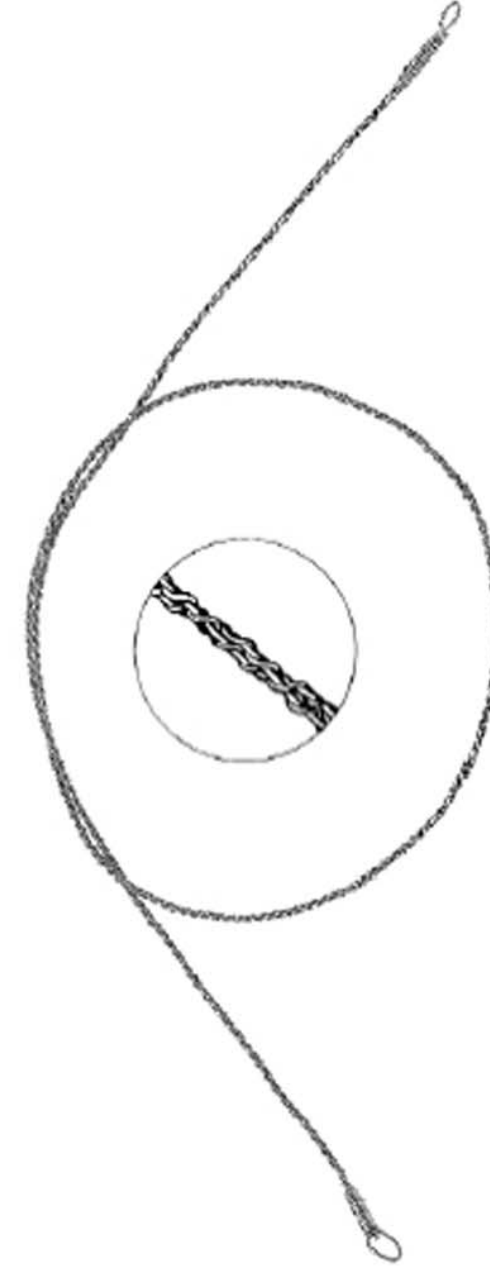

### OLIVECRONA

23 cm/9"	<b>40.092.22</b>
30 cm/12"	<b>40.092.30</b>
40 cm/16"	<b>40.092.40</b>
50 cm/20"	<b>40.092.50</b>
60 cm/24"	<b>40.092.60</b>
70 cm/28"	<b>40.092.70</b>
75 cm/30"	<b>40.092.75</b>

### GIGLI

25 cm/10"	<b>40.093.25</b>
30 cm/12"	<b>40.093.30</b>
40 cm/16"	<b>40.093.40</b>
50 cm/20"	<b>40.093.50</b>
60 cm/24"	<b>40.093.60</b>
70 cm/28"	<b>40.093.70</b>

### OLIVECRONA-GIGLI

30 cm/12"	<b>40.094.30</b>
40 cm/16"	<b>40.094.40</b>
50 cm/20"	<b>40.094.50</b>
60 cm/24"	<b>40.094.60</b>
70 cm/28"	<b>40.094.70</b>

4 x



# MULTICRAFTS Corporation

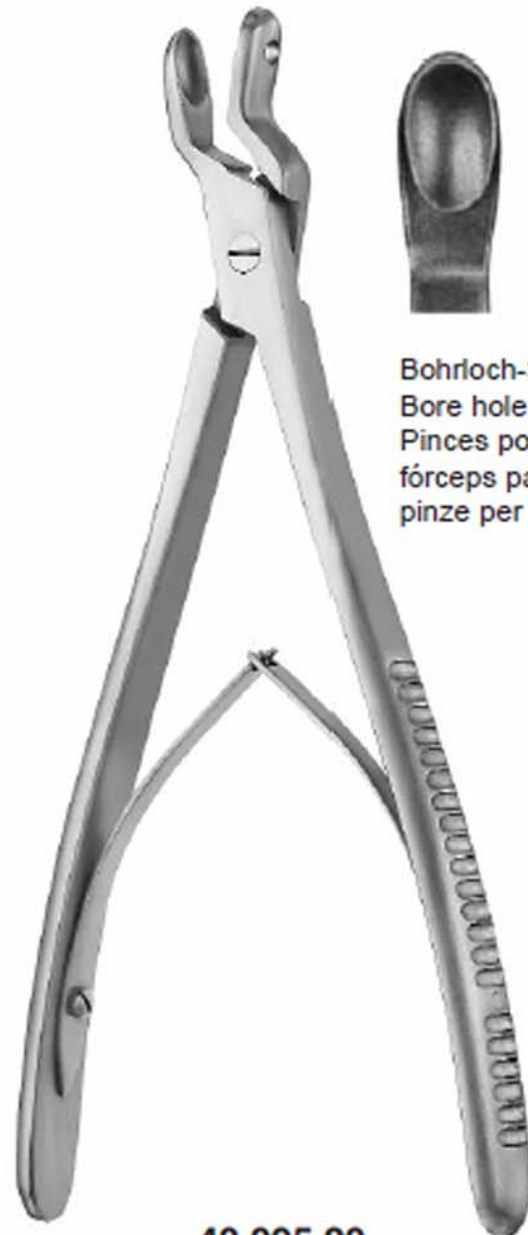

**40.095.20**  
20,5 cm/8"

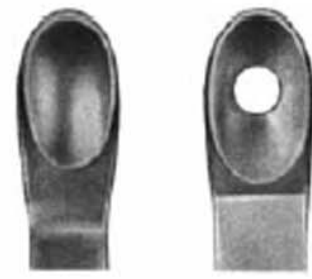

Bohrloch-Schutzzange  
Bore hole protection forceps  
Pinces pour protéger alésage  
fórceps para la protección de orificio  
pinze per la protezione di foro



CONE

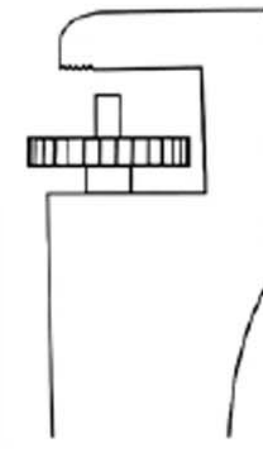

**40.098.20**  
20 cm/8"

bis 7 mm Schädelstärke  
for skull thickness up to 7 mm  
pour épaisseur de la boîte crânienne jusqu'à 7 mm  
hasta 7 mm de espesor de la pared craneal  
per spessore cranico fino a mm. 7

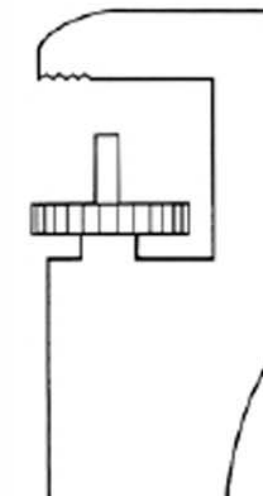

**40.098.23**  
23 cm/9"

bis 12 mm Schädelstärke  
for skull thickness up to 12 mm  
pour épaisseur de la boîte crânienne jusqu'à 12 mm  
hasta 12 mm de espesor de la pared craneal  
per spessore cranico fino a mm. 12



**DeVILBISS**  
**40.096.21**  
21 cm/8¼"

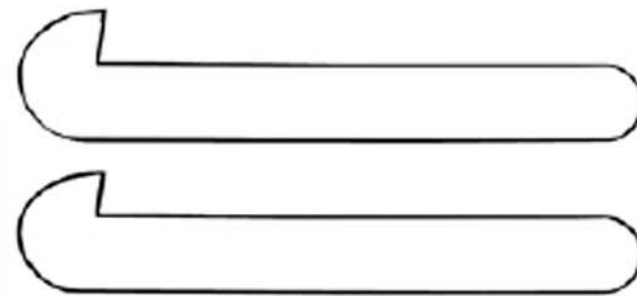

komplett mit je 1 kleinen und 1 großen Blatt  
complete with 1 small and 1 large blade  
complète avec 1 petit et 1 grand crochet  
completa con 1 gancho pequeño y 1 gancho grande  
completa di 1 uncino piccolo ed 1 uncino grande



**DAHLGREN**  
**40.097.20**  
21 cm/8¼"



komplett mit 2 Reserveblättern  
complete with 2 spare blades  
complète avec 2 crochets de rechange  
completa con 2 ganchos de repuesto  
completa di 2 Uncini di ricambio

# Neuro Spinal



# MULTICRAFTS Corporation

## Neuro Spinal

Dura - und Hauthäkchen  
 Dura and skin hooks  
 Crochets à dure-mère, Crochets dermatologiques  
 Ganchitos para dura-madre y piel  
 Uncini per dura madre, Uncini per la pelle

### SURGICAL INSTRUMENTS

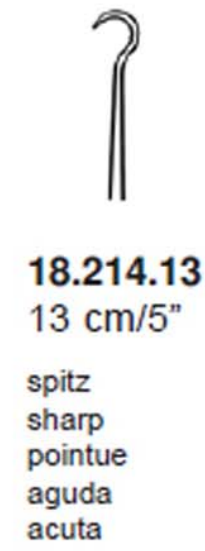
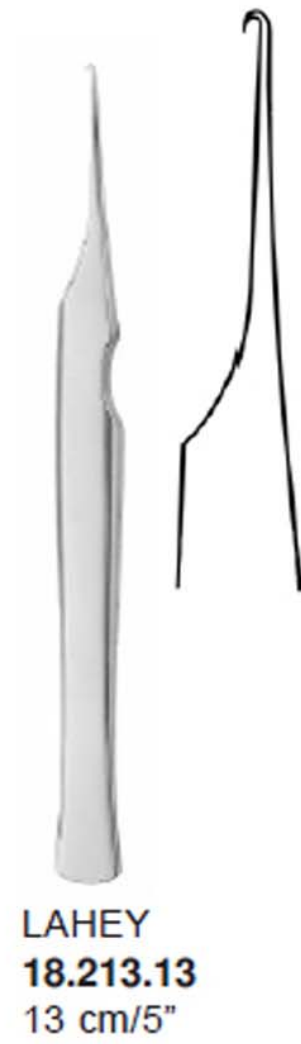

spitz  
sharp  
pointue  
aguda  
acuta

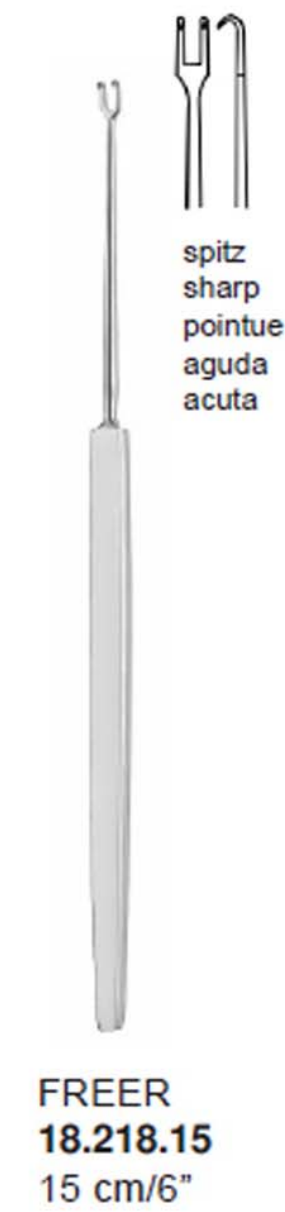



# MULTICRAFTS Corporation

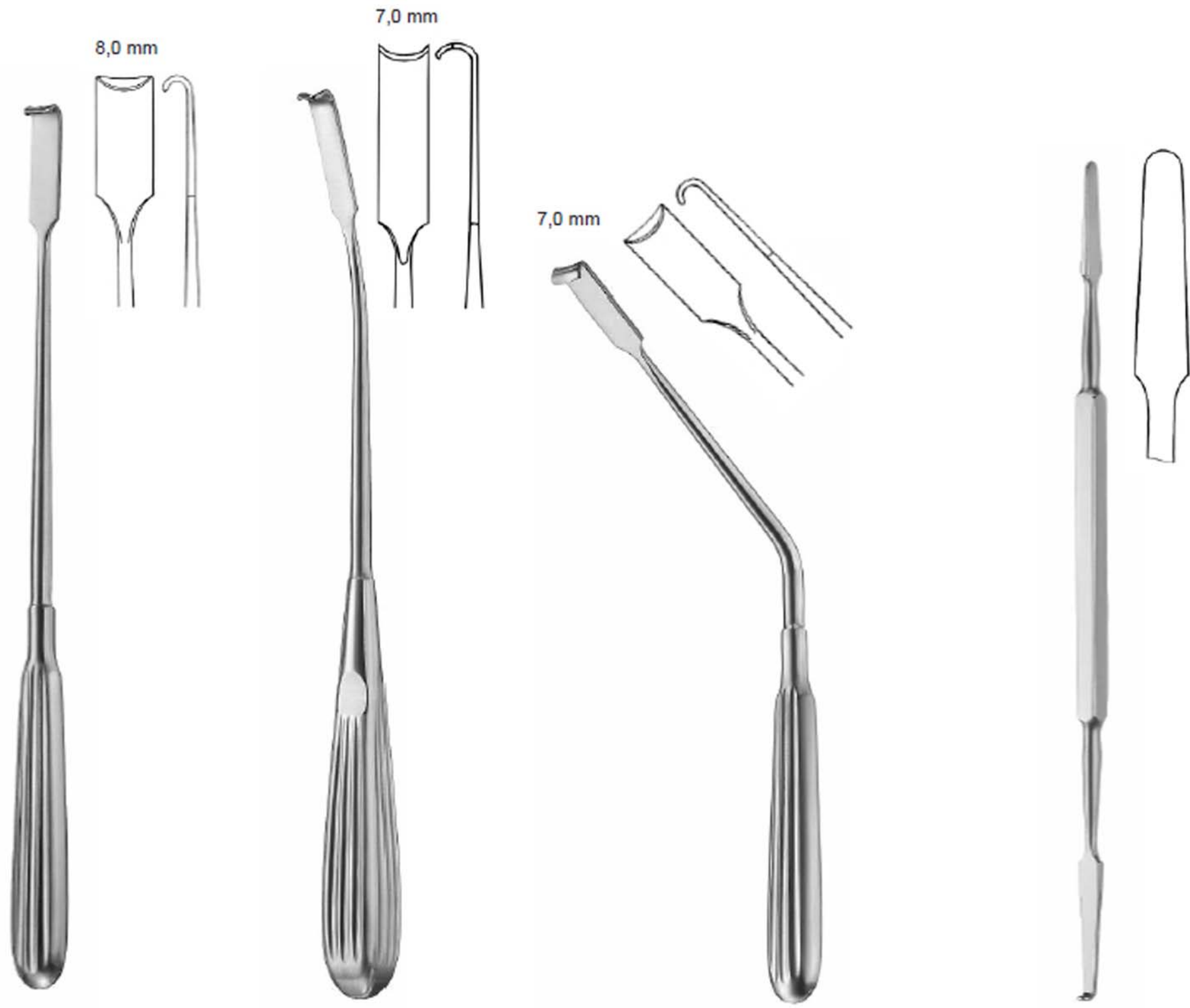

SCOVILLE  
40.044.23  
23 cm/9"

HOLSCHER  
40.045.24  
24 cm/9½"

SCOVILLE  
40.048.19  
19 cm/7½"

O'CONNELL  
40.046.22  
22 cm/8¾"



40.049.21  
21 cm/8¼"



links  
left  
à gauche  
a la izquierda  
sinistra

DANDY  
40.051.20  
20 cm/8"



DANDY  
40.052.20  
20 cm/8"



rechts  
right  
à droite  
a la derecha  
destra

DANDY  
40.053.20  
20 cm/8"

# Neuro Spinal



## Neuro Spinal



**CRILE**  
40.054.20  
20 cm/8"  
Fig. 1



**CUSHING**



Fig. 1      Fig. 2  
40.056.19    40.058.19  
19 cm/7½"    19 cm/7½"  
40.056.28    40.058.28  
28 cm/11"    28 cm/11"



**HOEN**  
40.060.23  
23 cm/9"



stumpf  
blunt  
mousse  
romo  
smusso



**GRAHAM**  
40.061.16  
16,5 cm/6½"



stumpf  
blunt  
mousse  
romo  
smusso



**SACHS**  
40.064.18  
18,5 cm/7¼"



spitz  
sharp  
pointue  
aguda  
acuta



**CASPAR**  
24,5 cm/9¾"

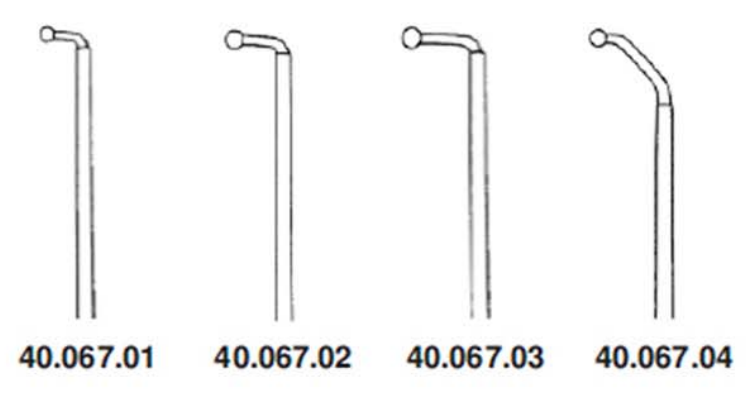

**CASPAR (CCR)** 132 - 136  
179 - 184  
Siehe auch Seite: 199  
See also page: 212  
Voir aussi la page: 228  
Véase también la página: 228  
Vedere anche pagina: 230



**ADSON**  
20 cm/8"

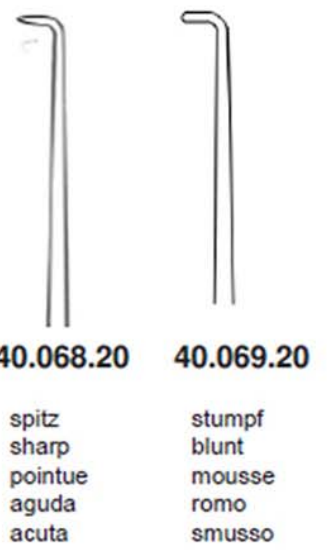

40.068.20    40.069.20  
spitz  
sharp  
pointue  
aguda  
acuta      stumpf  
blunt  
mousse  
romo  
smusso



**GRONINGEN**  
26,5 cm/10½"

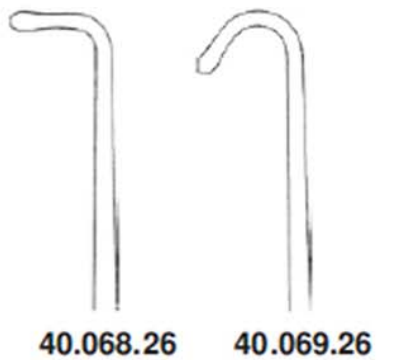

40.068.26    40.069.26



# MULTICRAFTS Corporation

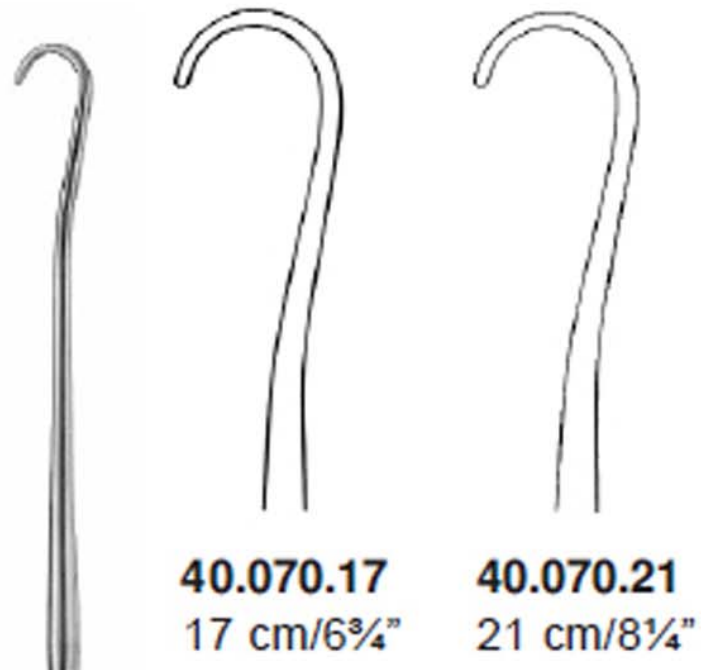

**40.070.17**  
17 cm/6¾"

**40.070.21**  
21 cm/8¼"

SMITHWICK



SMITHWICK  
**40.070.29**  
29 cm/11½"



SCOVILLE  
**40.070.30**  
30 cm/12"



SCOVILLE  
**40.071.30**  
30 cm/12"

## Neuro Spinal



# MULTICRAFTS Corporation

## Neuro Spinal



LOVE  
40.071.21  
21 cm/8 3/4"



CASPAR  
24 cm/9 1/2"  
6 mm 40.072.06  
8 mm 40.072.08  
10 mm 40.072.10



40.073.03 3 mm  
40.073.05 5 mm  
40.073.07 7 mm



HESS (LOVE modif.)  
17,5 cm/7"

CASPAR (CCR)	132 - 136
	179 - 184
Siehe auch Seite:	199
See also page:	212
Voir aussi la page:	228
Véase también la página:	228
Vedere anche pagina:	230

Aneurysmen-Nadel  
Aneurysm needle  
Aiguille à aneurysme  
Aguja para aneurisma  
Ago da aneurisma



ADSON  
40.078.22  
22 cm/8 3/4"  
2 mm



LOVE  
40.080.19  
19 cm/7 1/2"



LOVE  
40.081.19  
19 cm/7 1/2"

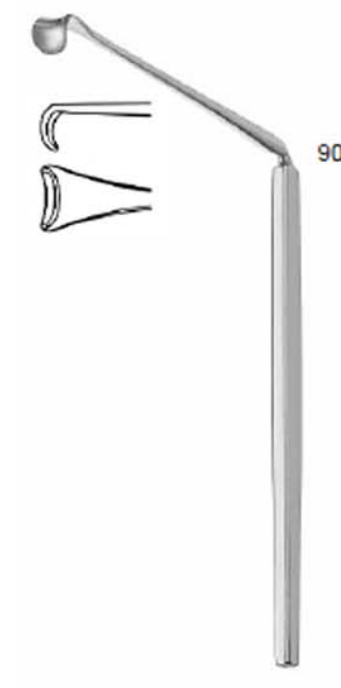

LOVE  
40.083.19  
19 cm/7 1/2"



# MULTICRAFTS Corporation

-  
Knochendeckel-Elevatorium  
Bone flap elevator  
Rugines-Raspatoires pour lambeau osseux  
Periostótomos para hueso solapa  
Periostotomi per lembo osseo

## SURGICAL INSTRUMENTS

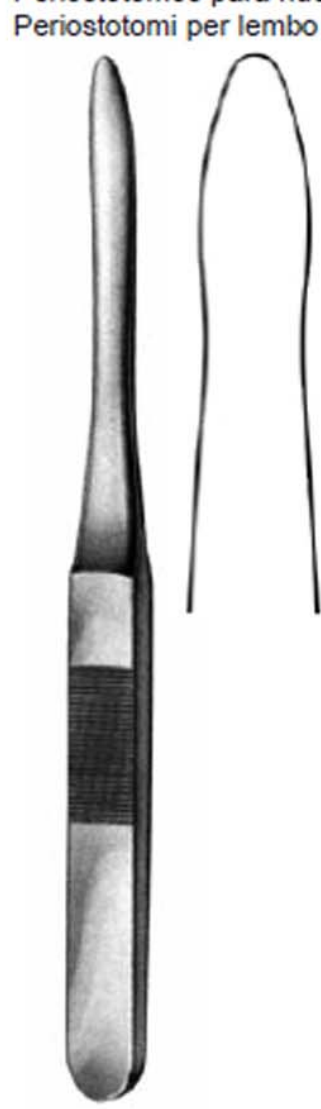

**40.102.17**  
17,5 cm/7"

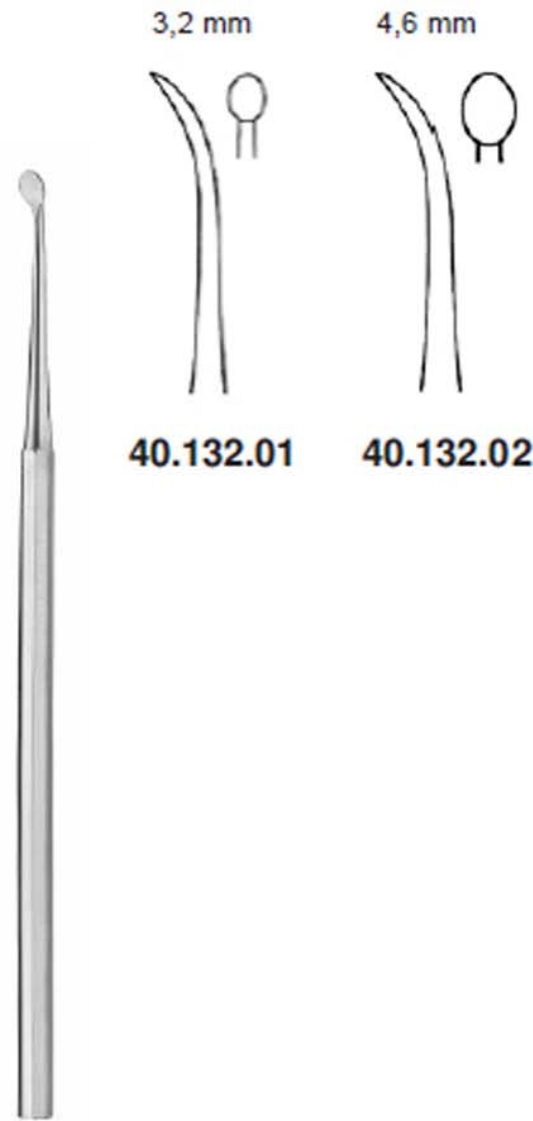

**PARTSCH**  
15 cm/6"



**LANGE**  
**40.132.14**  
14,5 cm/5 3/4"

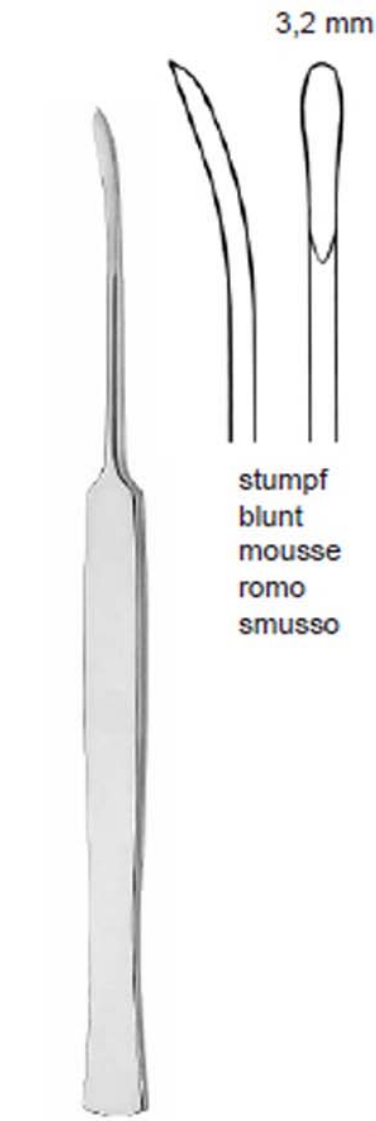

**LEMPERT**  
**40.133.16**  
16,5 cm/6 1/2"

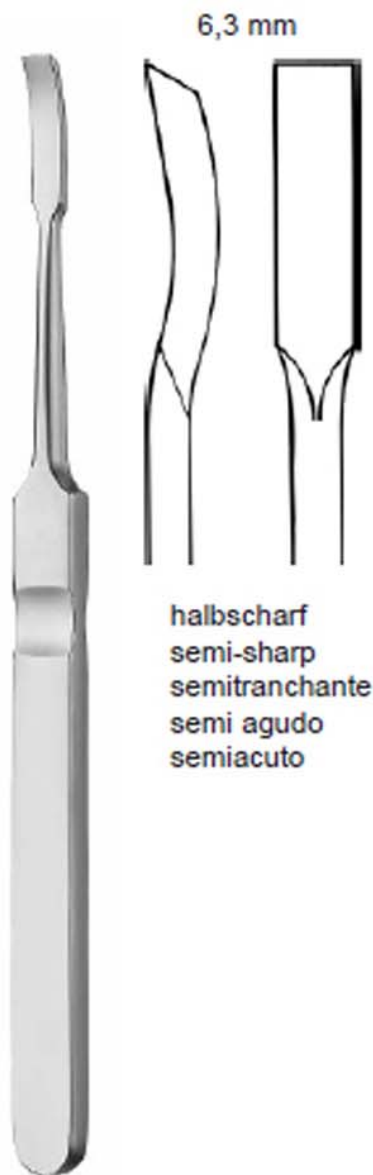

**LEMPERT**  
**40.134.18**  
18,5 cm/7 1/4"

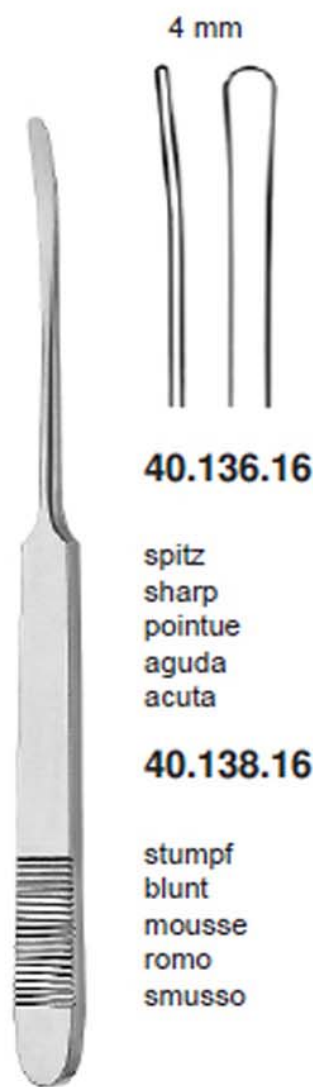

**ST CLAIR THOMPSON**  
16 cm/6 1/4"



**HALLE**  
**40.139.16**  
16 cm/6 1/4"  
3,5 mm



**SUNDAY**  
**40.140.23**  
23 cm/9"

# Neuro Spinal





## Neuro Spinal



**TOENNIS**  
25 cm/10"



**40.141.25** **40.142.25**  
Fig. 1 Fig. 2

Duradisektoren  
Dura Dissectors  
Dissecteurs à dure-mère  
Disecadores para duramadre  
Dissettori per la dura-madre



**SACHS**  
**40.143.21**  
21 cm/8¼"



spitz  
sharp  
pointue  
aguda  
acuta



**SACHS**  
**40.145.21**  
21 cm/8¼"



spitz  
sharp  
pointue  
aguda  
acuta



**MILLIGAN**  
**40.147.21**  
21 cm/8¼"



Sonde und Dissektor  
Probe dissector  
Sonde et dissector  
Sonda y disecador  
sonda e dissetore

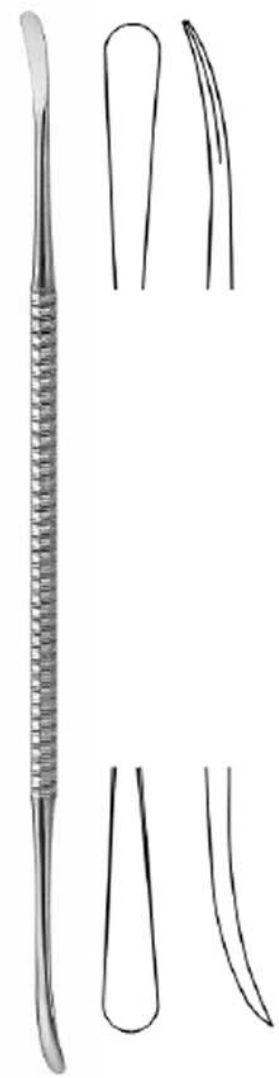

**MILLIGAN**  
**40.149.22**  
22 cm/8¾"



**PENNYBAKER**  
**40.149.23**  
23 cm/9"



**DAVIS**  
**40.151.24**  
24,5 cm/9¾"

Dura-Elevatoren  
Dura separators  
Separateurs per dure-mère  
Separadores para duramadre  
Elevatori per la dura-madre



**FRAZIER**  
**40.152.01**

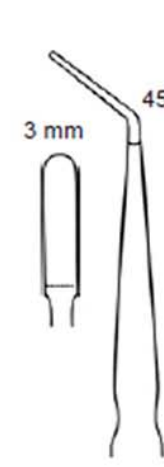

**HOEN**  
**40.152.02**

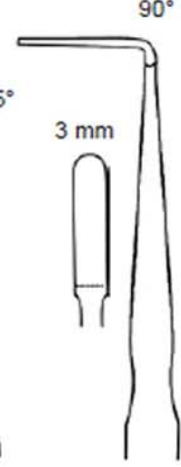

**HOEN**  
**40.152.03**

90°

45°

4 mm

3 mm

3 mm

15 cm/6"



# MULTICRAFTS Corporation

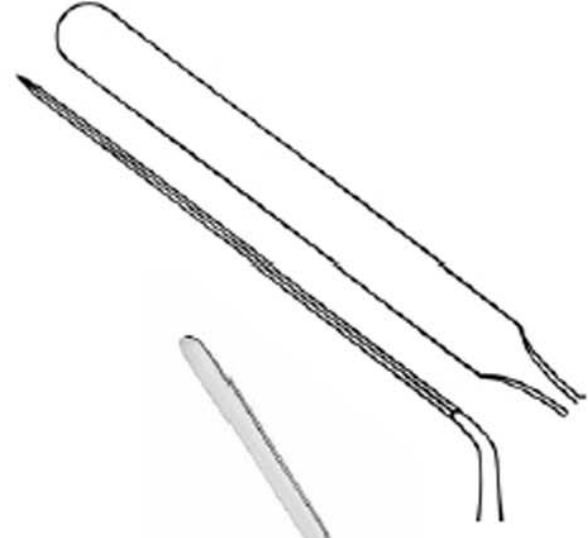

Dissektor mit flexiblem Schaft  
 Dissector with flexible shaft  
 Dissecteur à arbre flexible  
 Dissector con eje flexible  
 Dissector con asta flessibile



**HORSLEY**  
**40.155.20**  
 20 cm/8"



**SACHS**  
**40.157.21**  
 21 cm/8 1/4"



**40.157.19**  
 4 mm

für Kinder  
 for children  
 pour les enfants  
 para los niños  
 per i bambini

**40.159.19**  
 7 mm

für Erwachsene  
 for adults  
 pour les adultes  
 para adultos  
 per adulti

**YASARGIL**  
 19,5 cm/7 3/4"



**PENFIELD**  
**40.161.01**  
 17,5 cm/7"  
 Fig. 1



**PENFIELD**  
**40.161.02**  
 19,5 cm/7 3/4"  
 Fig. 2



**PENFIELD**  
**40.161.03**  
 19,5 cm/7 3/4"  
 Fig. 3



**PENFIELD**  
**40.161.04**  
 20,5 cm/8"  
 Fig. 4



**PENFIELD**  
**40.161.05**  
 18,5 cm/7 1/4"  
 Fig. 5

## Neuro Spinal



## Neuro Spinal

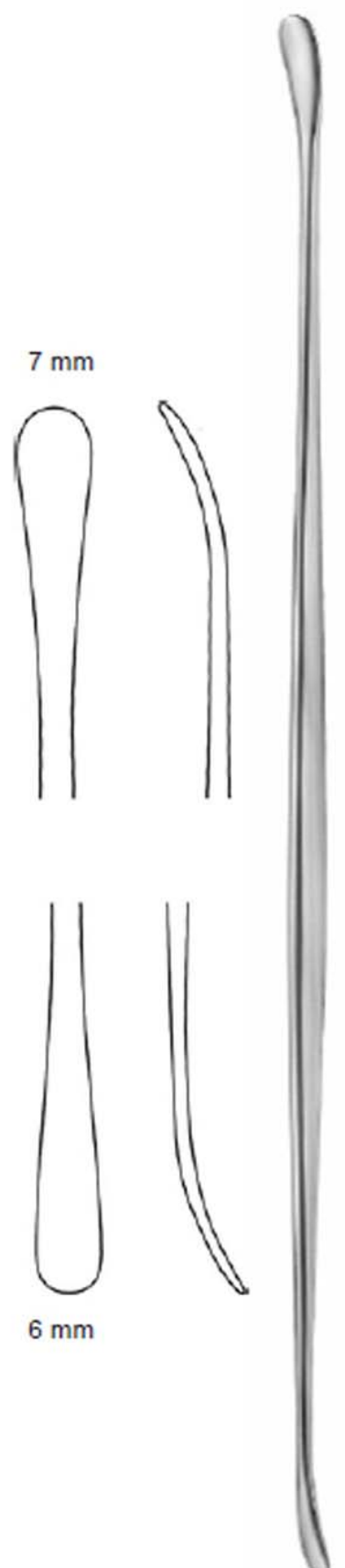

**40.162.29**  
29 cm/11½"

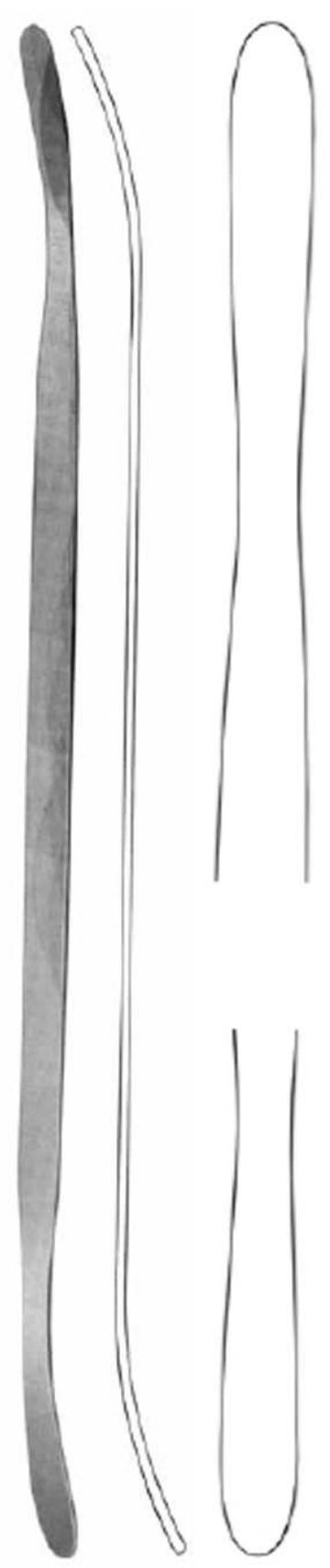

**40.163.29**  
29 cm/11½"

Trigeminalmesser  
Trigeminal knife  
Couteau pour trigêmeau  
Cuchillo para trigémino  
Coltello per trigemino

Duramesser  
Dura knife  
Couteau pour dure-mère  
Cuchillo para duramadre  
Coltello per la dura-madre

Chordotome  
Cordotome  
Cordotomes  
Cordotomi  
Cordotomi



**FRAZIER**  
**40.167.18**  
18 cm/7"



**40.167.23**  
23 cm/9"



**TOENNIS**

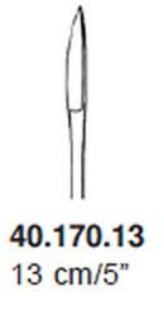

**40.170.13**  
13 cm/5"



**40.170.19**  
19 cm/7½"



**HALLE**  
**40.170.20**  
20 cm/8"



# MULTICRAFTS Corporation

## SURGICAL INSTRUMENTS

Nerv- und Gefäßhäkchen  
Nerve and vessel hooks  
Crochets à nerfs et à vaisseaux  
Ganchos para nervios y vasos  
Uncini per nervi e vasi



**KRAYENBÜHL**  
**40.065.01**  
Fig. 1



**KRAYENBÜHL**  
**40.065.02**  
Fig. 2



**KRAYENBÜHL**  
**40.065.03**  
Fig. 3



**KRAYENBÜHL**  
**40.065.04**  
Fig. 4

Fadenführer, geknüpft  
Ligature Guides and Carriers, probe pointed  
Passe-fils  
Guía-ligadura, abotonado  
Guide per legatura



**YASARGIL**  
**40.064.01**  
Fig. 1



**YASARGIL**  
**40.064.02**  
Fig. 2



**YASARGIL**  
**40.064.03**  
Fig. 3



**YASARGIL**  
**40.064.04**  
Fig. 4

18,5 cm/7¼"

Gefäß Messer  
Vessel knife  
Couteau pour vaisseaux  
Cuchillo para vasos  
Coltello per vasi



18,5 cm/7¼"



**KOOS**  
**40.065.51**

aufgebogen  
upwards curved  
courbe vers le haut  
curva hacia arriba  
curvo in sú



**KOOS**  
**40.065.52**

abgebogen  
downward curved  
courbe vers le bas  
curva hacia abajo  
curvo in giù



**KOOS**  
**40.065.53**

aufgebogen  
upwards curved  
courbe vers le haut  
curva hacia arriba  
curvo in sú



**KOOS**  
**40.065.54**

abgebogen  
downward curved  
courbe vers le bas  
curva hacia abajo  
curvo in giù



**KOOS**  
**40.065.57**

aufgebogen  
upwards curved  
courbe vers le haut  
curva hacia arriba  
curvo in sú



**KOOS**  
**40.065.56**

abgebogen  
downward curved  
courbe vers le bas  
curva hacia abajo  
curvo in giù

Arachnoidea Messer  
Arachnoid knife  
Couteaux arachnoïdiens  
Arachnoidea cuchillos  
Arachnoidea coltelli



**YASARGIL**  
**40.065.65**

abgebogen  
downward curved  
courbe vers le bas  
curva hacia abajo  
curvo in giù



**YASARGIL**  
**40.065.66**

aufgebogen  
upwards curved  
courbe vers le haut  
curva hacia arriba  
curvo in sú

# Neuro Spinal



**Neuro Spinal**



**YASARGIL**  
19 cm/7½"



**40.066.01**



**40.066.02**



**40.066.03**



**40.066.04**



**40.066.16**  
12,5 cm/5"



**40.066.17**  
12,5 cm/5"



Gefäßspreizer  
Vessel Spreader  
Ecarteur pour vaisseaux  
Separador para vasos  
Divaricatore per vasi

**BIEMER**  
**40.066.10**  
16 cm/6¼"

Ø 0,5 mm



**40.066.16**  
12,5 cm/5"

Ø 1,0 mm



**40.066.17**  
12,5 cm/5"

Ø 1,5 mm



**40.066.18**  
12,5 cm/5"

Gefäßdilator  
Vessel Dilator  
Dilatateurs vasculaires  
Dilatadores vasculares  
Dilattori vascolari



**JACOBSON**  
**40.066.19**  
18,5 cm/7¼"



**JACOBSON**  
**40.066.20**  
18,5 cm/7¼"

Knopfsonde  
Buttoned probes  
Sondes boutonées  
Sondas abotonadas  
Sonde bottonute



# MULTICRAFTS Corporation



SAMII  
23 cm/9"

Tumormesser  
Tumor knives  
Couteaux à tumeurs  
Cuchillos para tumores  
Coltelli per tumori



40.075.10 1,0 mm  
40.075.11 1,5 mm



40.075.12 2,0 mm  
40.075.13 2,5 mm



40.075.14 3,0 mm  
40.075.15 3,5 mm

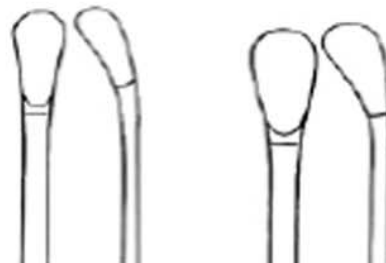

40.075.16 4,0 mm  
40.075.18 5,0 mm

Messer für Tumorgewebe  
Knives for tumor tissue  
Couteaux pour tissu de tumeur  
Cuchillos para tejidos con tumores  
Coltelli per tessuto tumorale

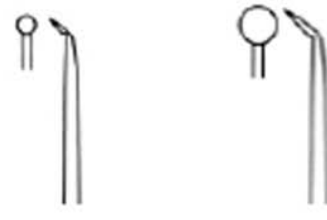

40.076.01 1,5 mm  
40.076.02 3,0 mm

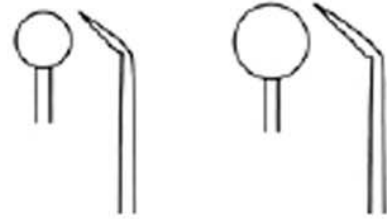

40.076.03 4,5 mm  
40.076.04 6,0 mm

Lanzettenmesser für Tumorgewebe  
Lancet knives for tumor tissue  
Couteaux lancéolaires pour tissu de tumeur  
Cuchillos en forma de lanceta para tejidos con tumores  
Coltelli lanceolato per tessuto tumorale



40.077.18 1,8 mm  
40.077.25 2,5 mm

Tumorgabeln  
Tumor forks  
Fourches à tumeurs  
Horquillas para tumores  
Forchette per tumori

5 mm 8 mm

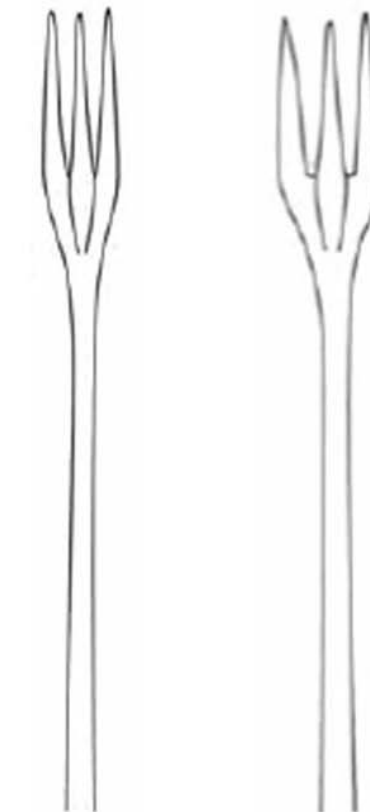

40.079.05 40.079.08



YASARGIL  
20 cm/8"

# Neuro Spinal



# MULTICRAFTS Corporation

## SURGICAL INSTRUMENTS

Dissektoren  
Dissectors  
Dissecteurs  
Disectores  
Dissettori

# Neuro Spinal



CASPAR  
244



40.171.01  
23 cm/9"  
4,5 mm

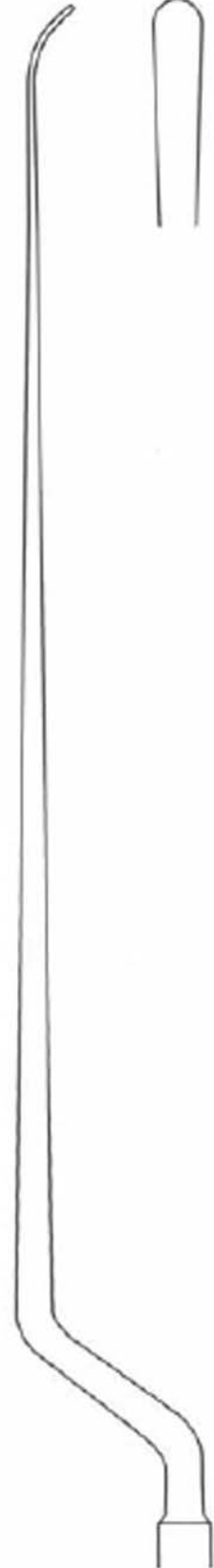

40.171.02  
23 cm/9"  
4,5 mm



40.171.03  
23 cm/9"  
2 mm



40.173.01  
20 cm/8"  
1 mm



40.173.02  
21 cm/8¼"  
1 mm



40.173.03  
21 cm/8¼"  
1 mm



# MULTICRAFTS Corporation

## SURGICAL INSTRUMENTS



biegsam  
malleable  
malléable  
maleable  
malleabile

### CUSHING

40.250.07	7/9 x 180 mm
40.250.11	11/13 x 180 mm
40.250.15	15/18 x 180 mm
40.250.18	18/22 x 180 mm

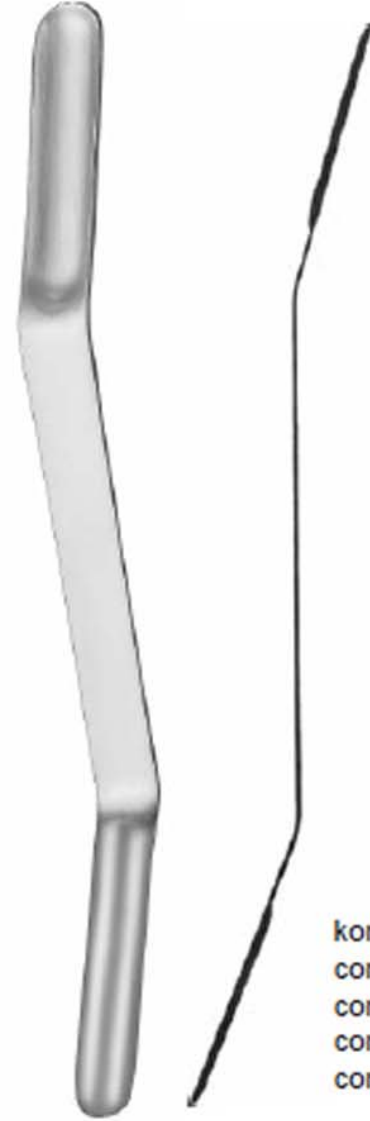

konvex  
convex  
convexe  
convexa  
convessa

### OLIVECRONA

40.252.13	7/9 x 180 mm
40.252.15	11/13 x 180 mm
40.252.17	15/18 x 180 mm
40.252.19	18/22 x 180 mm

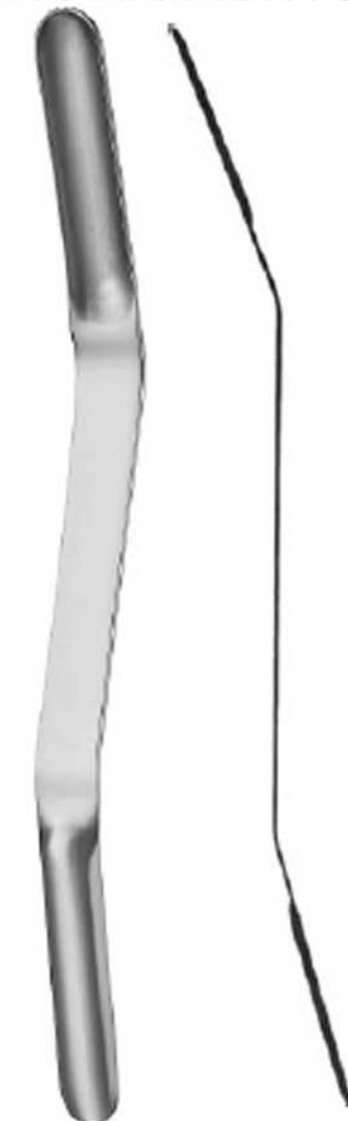

konkav  
concave  
cóncava  
concava

### OLIVECRONA

40.253.07	7/9 x 180 mm
40.253.11	11/13 x 180 mm
40.253.15	15/18 x 180 mm
40.253.18	18/22 x 180 mm



biegsam  
malleable  
malléable  
maleable  
malleabile

### SCOVILLE

40.254.10	10/13 x 200 mm
40.254.16	16/19 x 200 mm



biegsam  
malleable  
malléable  
maleable  
malleabile

### AACHEN

40.256.07	7/8 x 200 mm
40.256.10	10/11 x 200 mm
40.256.13	13/14 x 200 mm
40.256.16	16/17 x 200 mm
40.256.19	19/20 x 200 mm
40.256.22	22/25 x 200 mm



biegsam  
malleable  
malléable  
maleable  
malleabile

40.257.01	9 x 200 mm
40.257.02	12 x 200 mm
40.257.03	12 x 250 mm

# Neuro Spinal





## Neuro Spinal

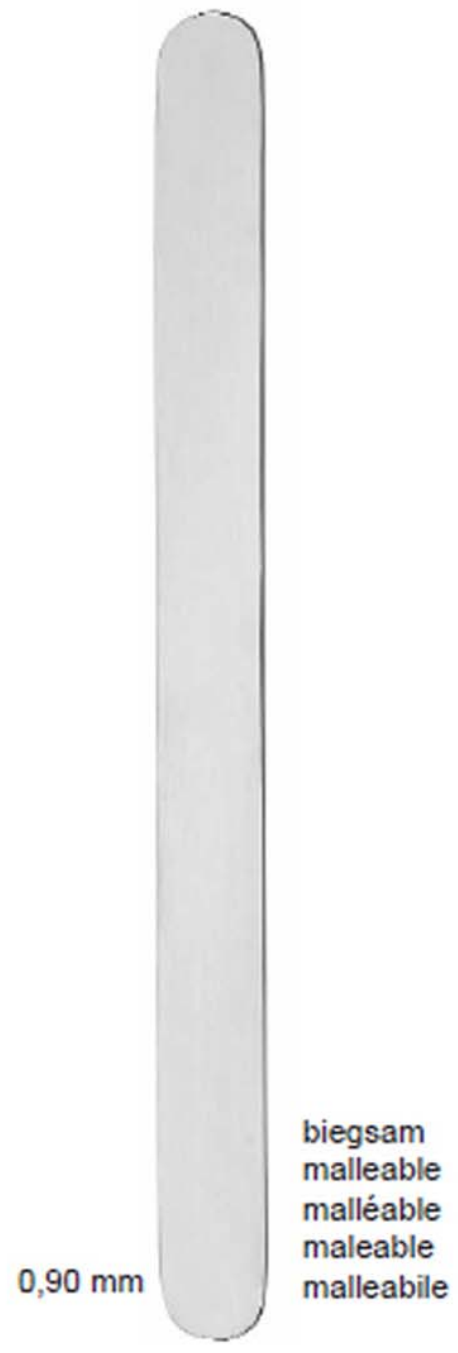

biegsam  
malleable  
malléable  
maleable  
malleabile

CAIRNS	
40.258.06	6 x 200 mm
40.258.08	8 x 200 mm
40.258.10	10 x 200 mm
40.258.11	11 x 200 mm
40.258.13	13 x 200 mm
40.258.16	16 x 200 mm
40.258.19	19 x 200 mm
40.258.25	25 x 200 mm

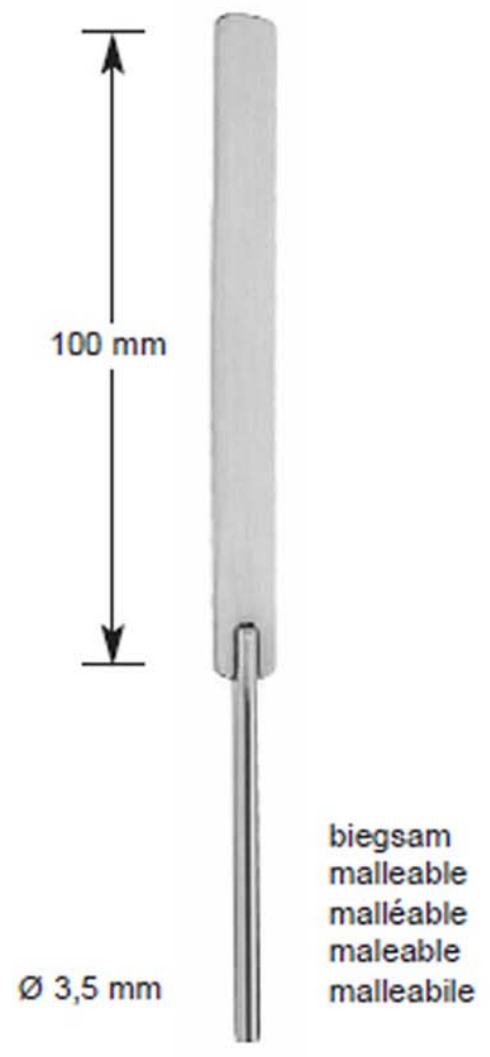

biegsam  
malleable  
malléable  
maleable  
malleabile

HEIFETZ	
40.259.08	8 x 155 mm
40.259.11	11 x 155 mm
40.259.14	14 x 155 mm
40.259.17	17 x 155 mm

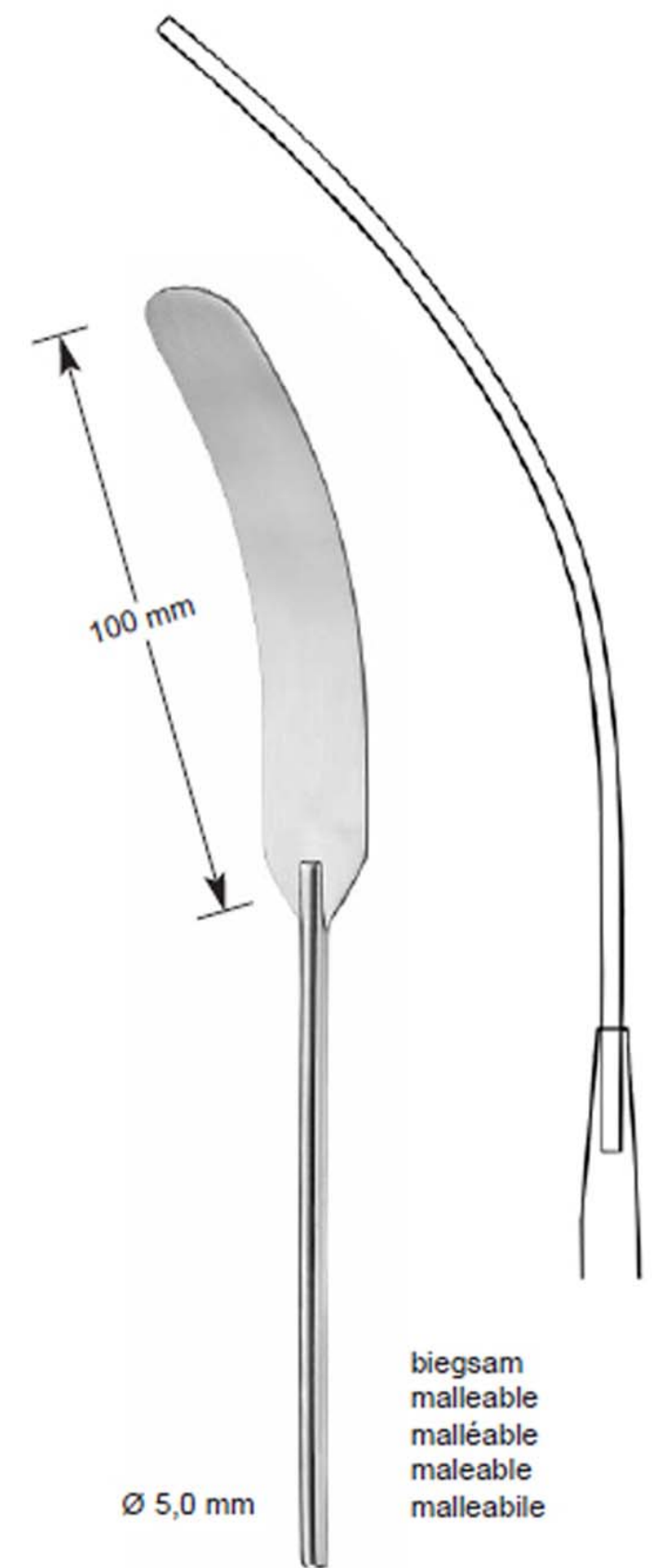

biegsam  
malleable  
malléable  
maleable  
malleabile

HEIFETZ	
40.260.08	8 x 200 mm
40.260.11	11 x 200 mm
40.260.14	14 x 200 mm
40.260.17	17 x 200 mm
40.260.20	20 x 200 mm



# MULTICRAFTS Corporation

## SURGICAL INSTRUMENTS

Nutzlänge  
working length  
longueur utile  
largo útil  
lunghezza utile

	ø 1,5 mm 4 - 5 Charr.	ø 2,0 mm 6 Charr.	ø 2,5 mm 7 - 8 Charr.	ø 3,5 mm 13 - 14 Charr.	ø 4,5 mm 16 - 17 Charr.
13 cm/5"	40.286.13	40.287.13	40.288.13	40.289.13	
15 cm/6"	40.286.15	40.287.15	40.288.15	40.289.15	
18 cm/7"	40.286.18	40.287.18	40.288.18	40.289.18	40.289.45
22 cm/8¾"	40.286.22	40.287.22	40.288.22	40.289.22	

Schlaucholive ø 6,5 - 9 mm  
Olive ø 6,5 - 9 mm  
Olive ø 6,5 - 9 mm  
Oliva ø 6,5 - 9 mm  
Oliva ø 6,5 - 9 mm

LUER  
YASARGIL

Saugkanülen mit Unterbrecher und Mandrin  
Suction Cannulae with finger cut-off and stylet  
Canules d'aspiration avec interrupteur à doigt  
Cánulas para aspiración con interruptor y estilete  
Cannule per aspirazione con interruttore e stiletto

mit zentraler Bohrung  
with central bore  
avec trou central  
con un foro centrale  
con un agujero central

04.148.27  
ø 2,0 mm

04.149.27  
ø 4,8 mm

04.155.30  
ø 3,0 mm  
Fig. 1

04.155.35  
ø 3,5 mm  
Fig. 2

04.155.40  
ø 4,0 mm  
Fig. 3

04.155.99  
Mandrin  
Stylet  
Doigt  
Esfilete  
Stiletto

12 cm/4¾"

YANKAUER  
28,5 cm/11¼"

MAGILL  
24,5 cm/9¾"

ADSON  
40.290.16  
16,5 cm/6½"  
ø 3 mm

ADSON  
40.290.21  
21 cm/8¼"  
ø 4 mm

FRAZIER  
40.290.24  
24 cm/9½"  
ø 3,3 mm

FRAZIER  
40.292.08  
ø 2,7 mm/ 8 charr.

# Neuro Spinal



# MULTICRAFTS Corporation

## Neuro Spinal

### SURGICAL INSTRUMENTS

ø 2 mm	40.283.02
ø 3 mm	40.283.03

Schlaucholive ø 7 - 9 mm  
 Olive ø 7 - 9 mm  
 Olive ø 7 - 9 mm  
 Oliva ø 7 - 9 mm  
 Oliva ø 7 - 9 mm



½  
**LEMPERT**  
 20 cm/8"

Ø mm	F.G. Charr.	11 cm/4¼"	13 cm/5"	16 cm/6¼"	20 cm/8"
ø 1,5 mm	4 - 5	40.270.15	40.271.15	40.272.15	40.273.15
ø 2,0 mm	6	40.270.20	40.271.20	40.272.20	40.273.20
ø 2,5 mm	7 - 8	40.270.25	40.271.25	40.272.25	40.273.25
ø 3,0 mm	9	40.270.30	40.271.30	40.272.30	40.273.30
ø 4,0 mm	12	40.270.40	40.271.40	40.272.40	40.273.40
ø 5,0 mm	15	40.270.50	40.271.50	40.272.50	40.273.50

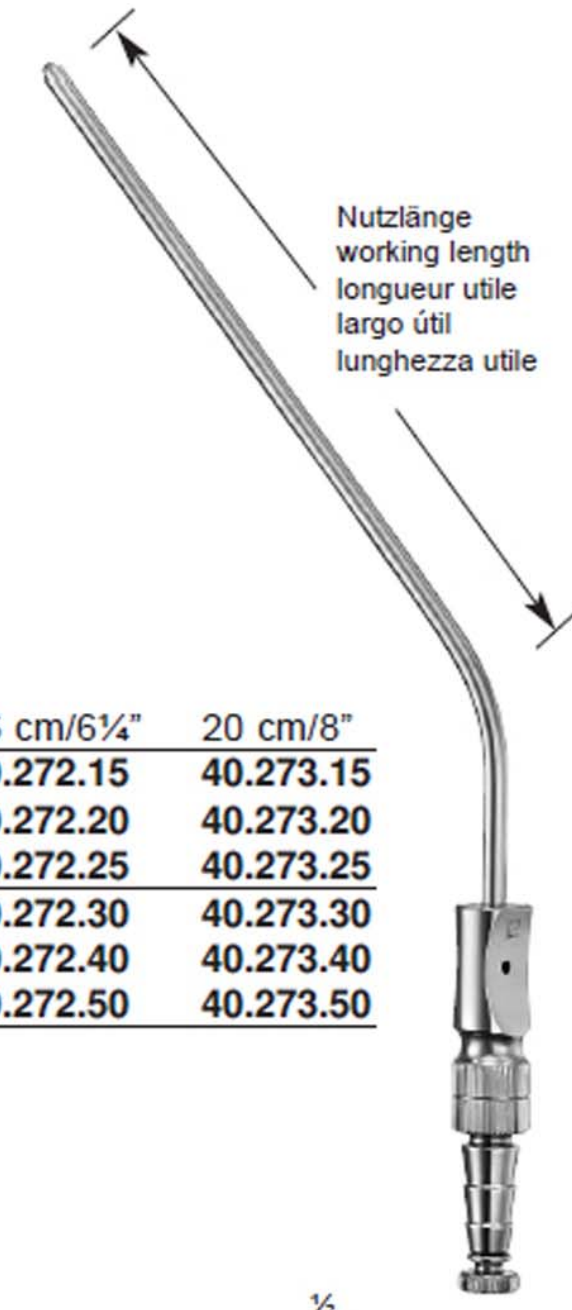

½  
**FERGUSSON**



½  
**FERGUSSON**  
 40.291.04  
 18 cm/7"  
 ø 4 mm

isoliert  
 insulated  
 isolée  
 aislados  
 isolato

Schlaucholive ø 6 - 9 mm  
 Olive ø 6 - 9 mm  
 Olive ø 6 - 9 mm  
 Oliva ø 6 - 9 mm  
 Oliva ø 6 - 9 mm

Saugkanülen mit Unterbrecher und Mandrin  
 Suction Cannulae with finger cut-off and stylet  
 Canules d'aspiration avec interrupteur à doigt  
 Cánulas para aspiración con interruptor y estilete  
 Cannule per aspirazione con interruttore e stiletto

F.G. Charr.	Ø mm	30°	75°
6	2,0	40.295.06	40.297.06
7	2,3	40.295.07	40.297.07
8	2,7	40.295.08	40.297.08
9	3,0	40.295.09	40.297.09
10	3,3	40.295.10	40.297.10
11	3,7	40.295.11	40.297.11
12	4,0	40.295.12	40.297.12
15	5,0	40.295.15	40.297.15



½  
**FRAZIER**  
 19 cm/7½"



# MULTICRAFTS Corporation

## SURGICAL INSTRUMENTS



FRAZIER

6 Charr.	40.293.06
8 Charr.	40.293.08
9 Charr.	40.293.09
10 Charr.	40.293.10
12 Charr.	40.293.12

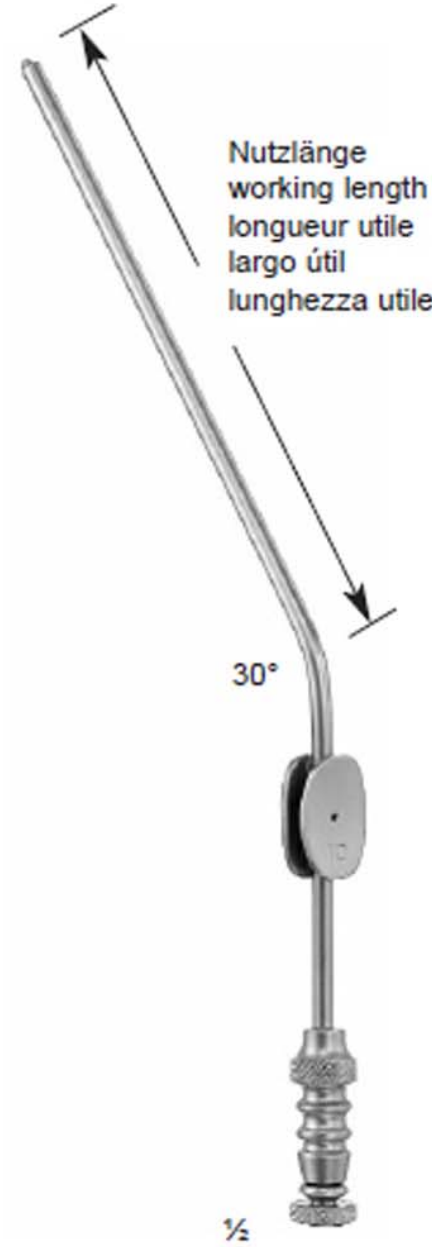

FRAZIER

F.G. Charr.	ø mm	12,5 cm/5"	18 cm/7"
6	2,0	40.296.06	40.296.16
8	2,7	40.296.08	40.296.18
10	3,3	40.296.10	40.296.30
12	4,0	40.296.12	40.296.32



FRAZIER

	19 cm/7½"
7 charr.	40.299.07
9 charr.	40.299.09
11 charr.	40.299.11

Spitze 6,5 mm breit  
tip 6.5 mm wide  
6,5 mm de large  
6,5 mm de ancho  
6,5 mm di larghezza

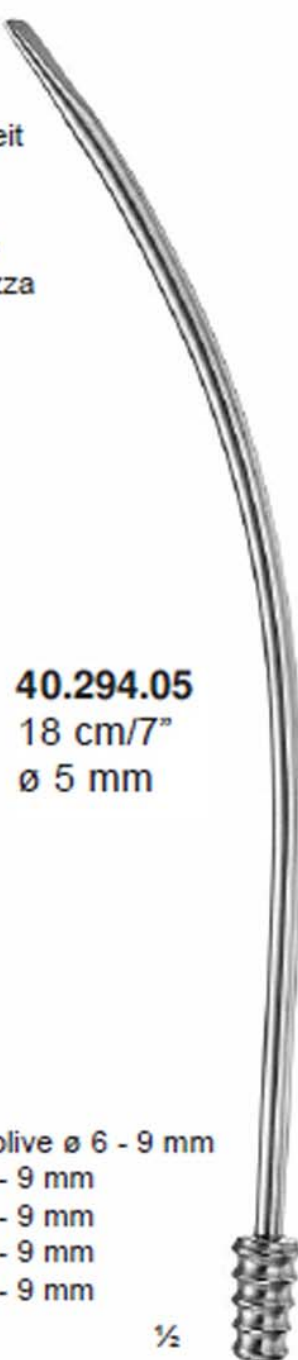

Schlaucholive ø 6 - 9 mm  
Olive ø 6 - 9 mm  
Olive ø 6 - 9 mm  
Oliva ø 6 - 9 mm  
Oliva ø 6 - 9 mm

ø 4,5 mm	40.307.45
ø 5,5 mm	40.307.55

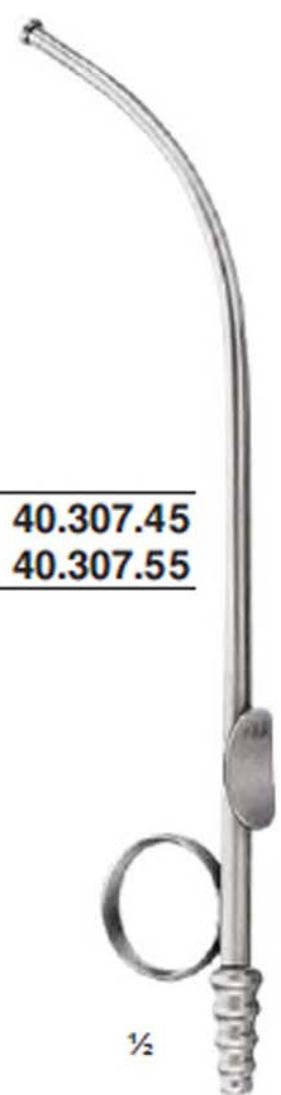

LUER  
17,5 cm/7"

4-5 charr.	ø 1,5 mm	40.313.15
6 charr.	ø 2,0 mm	40.313.20
7-8 charr.	ø 2,5 mm	40.313.25
9 charr.	ø 3,0 mm	40.313.30

Schlaucholive ø 6 - 9 mm  
Olive ø 6 - 9 mm  
Olive ø 6 - 9 mm  
Oliva ø 6 - 9 mm  
Oliva ø 6 - 9 mm

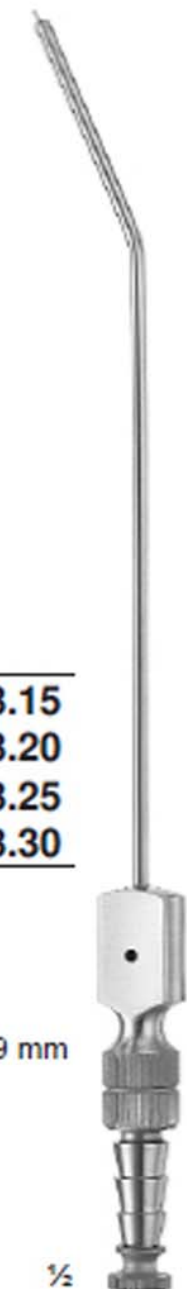

PLESTER  
19 cm/7½"

# Neuro Spinal



### SURGICAL INSTRUMENTS



**FRAZIER**  
12 cm/4 3/4"

ø 2,0 mm	40.298.08
ø 2,5 mm	40.298.10
ø 3,0 mm	40.298.12

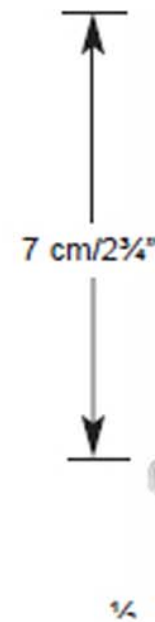

ø 2,0 mm	40.300.20
ø 2,5 mm	40.300.25



**CONE**  
9 cm/3 1/2"

12 G.	ø 2,64 mm	40.302.12
13 G.	ø 2,24 mm	40.302.13
14 G.	ø 2,03 mm	40.302.14
15 G.	ø 1,83 mm	40.302.15
16 G.	ø 1,62 mm	40.302.16
17 G.	ø 1,42 mm	40.302.17
18 G.	ø 1,22 mm	40.302.18
20 G.	ø 0,91 mm	40.302.20

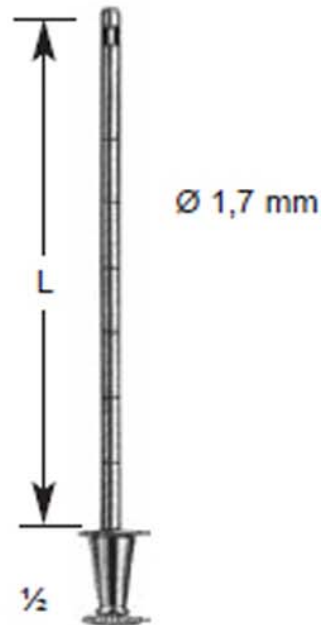

**JEFFERSON**

8 cm/3 1/4"	40.301.08
10 cm/4"	40.301.10



**DANDY**

ø 2,0 mm	40.303.20
----------	-----------

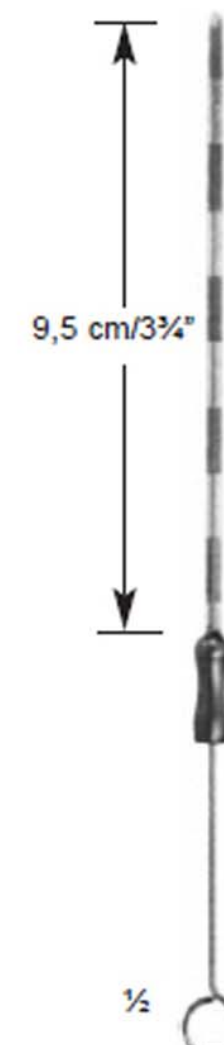

**CUSHING-CAIRNS**

ø 2,3 mm	40.304.23
ø 2,6 mm	40.304.26



# MULTICRAFTS Corporation

## SURGICAL INSTRUMENTS

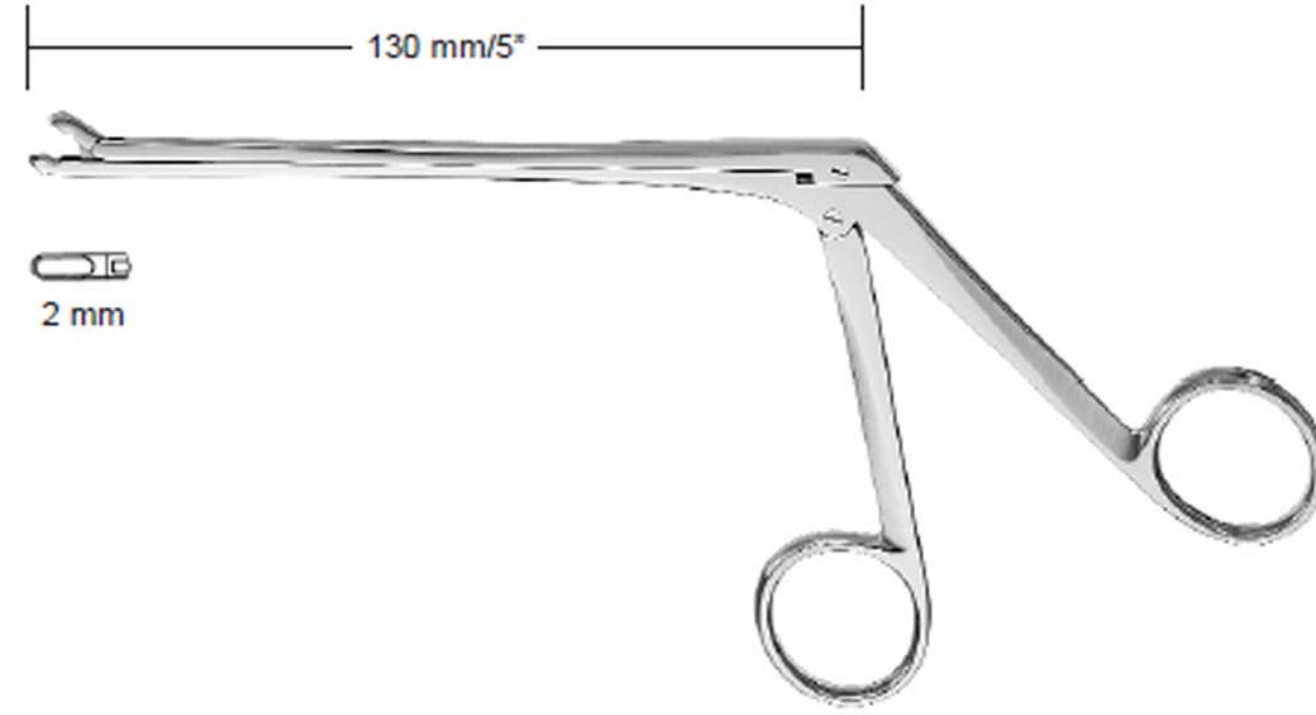

BECK  
40.413.02



PENNYBACKER  
40.423.03

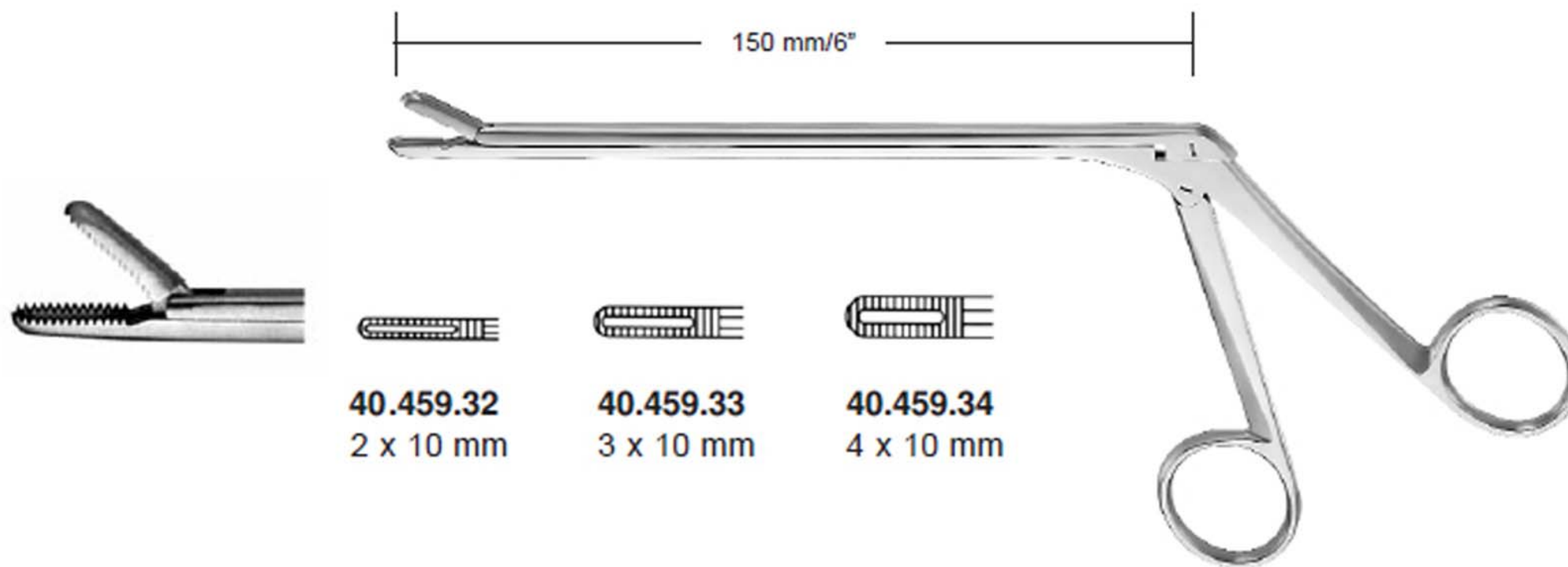

SCHLESINGER

40.459.32  
2 x 10 mm

40.459.33  
3 x 10 mm

40.459.34  
4 x 10 mm

# Neuro Spinal



# MULTICRAFTS Corporation

SURGICAL INSTRUMENTS

## Neuro Spinal

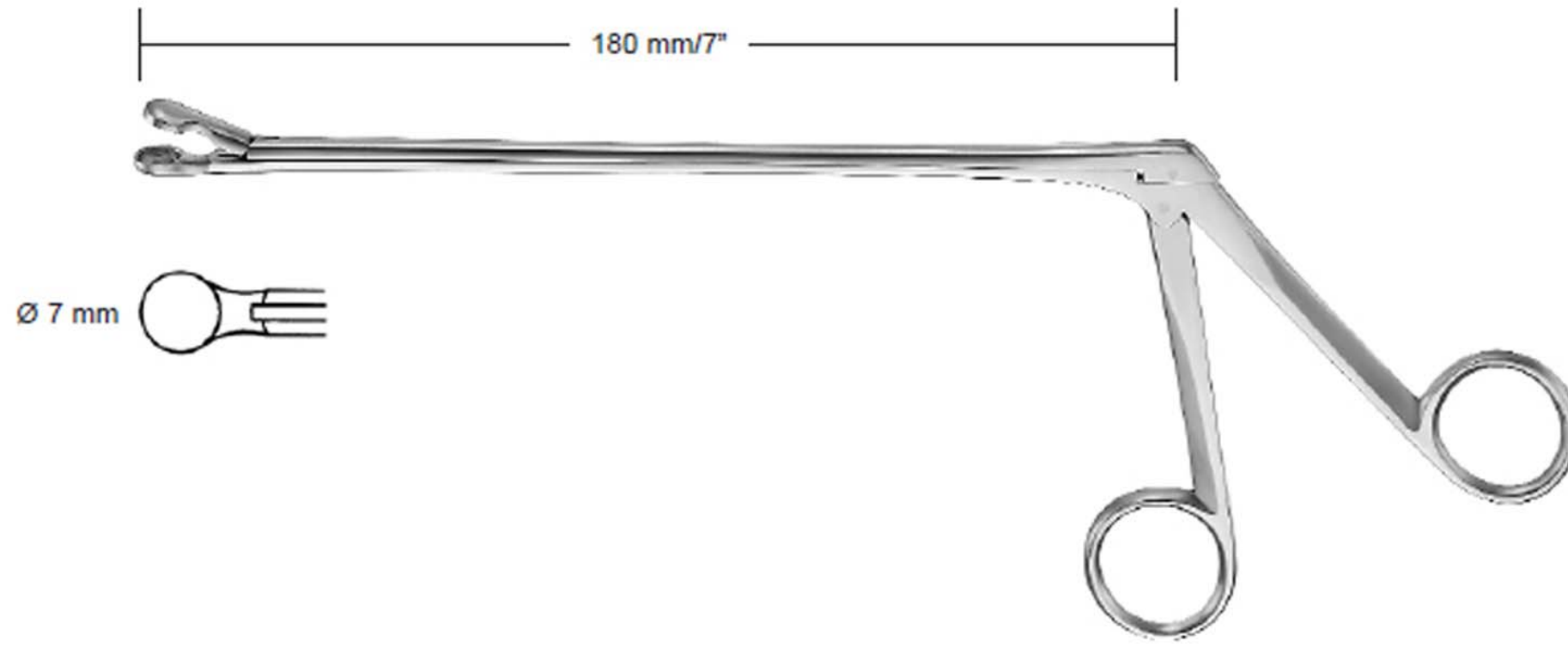

OLDBERG  
40.445.25  
25 cm/10"

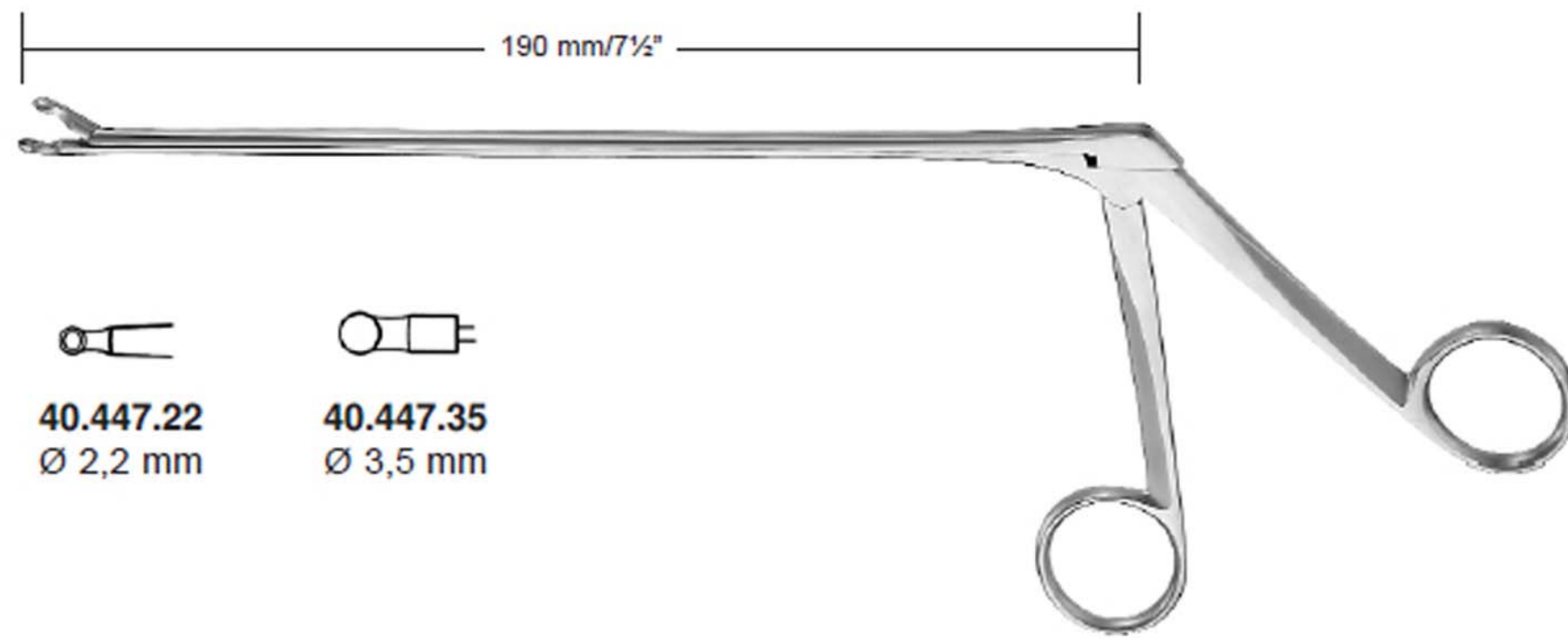

40.447.22  
Ø 2,2 mm

40.447.35  
Ø 3,5 mm

YASARGIL

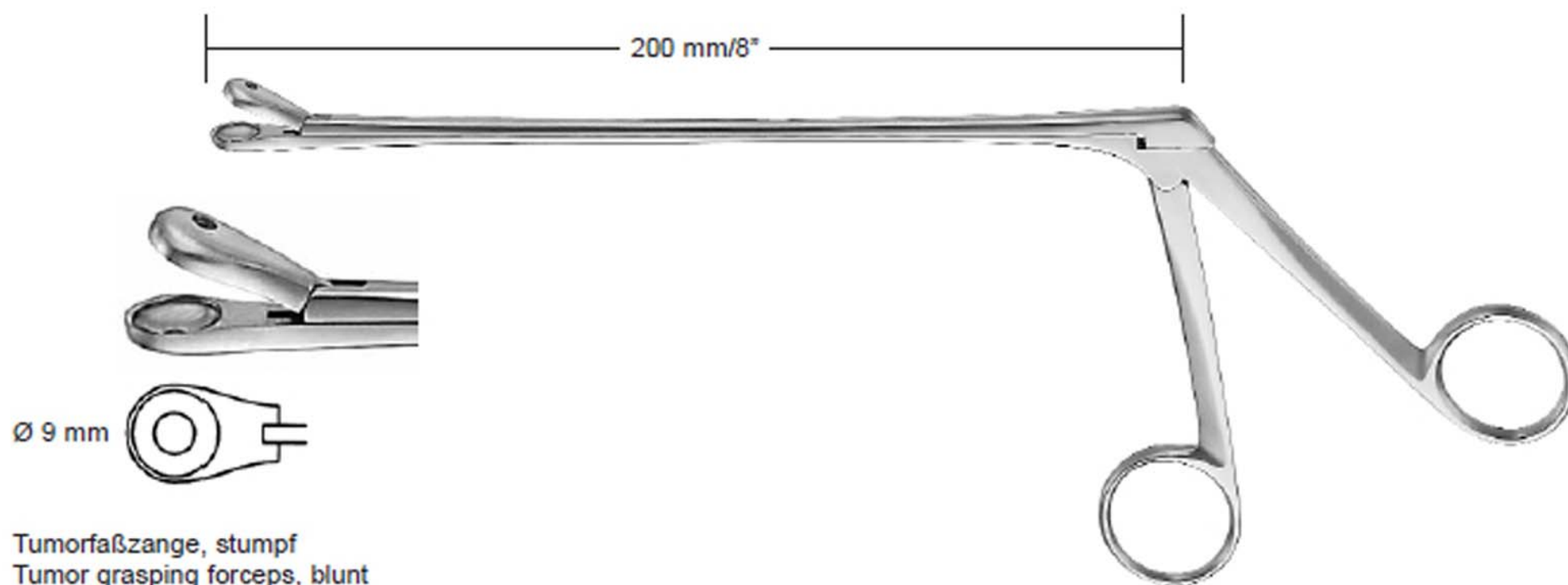

Tumorfäßzange, stumpf  
Tumor grasping forceps, blunt  
Pincès pour préhension de tumeurs, mousse  
Pinzas para agarrar tumores, romo  
Pinze per afferrare tumori, smusso

LANDOLT  
40.448.20



# MULTICRAFTS Corporation

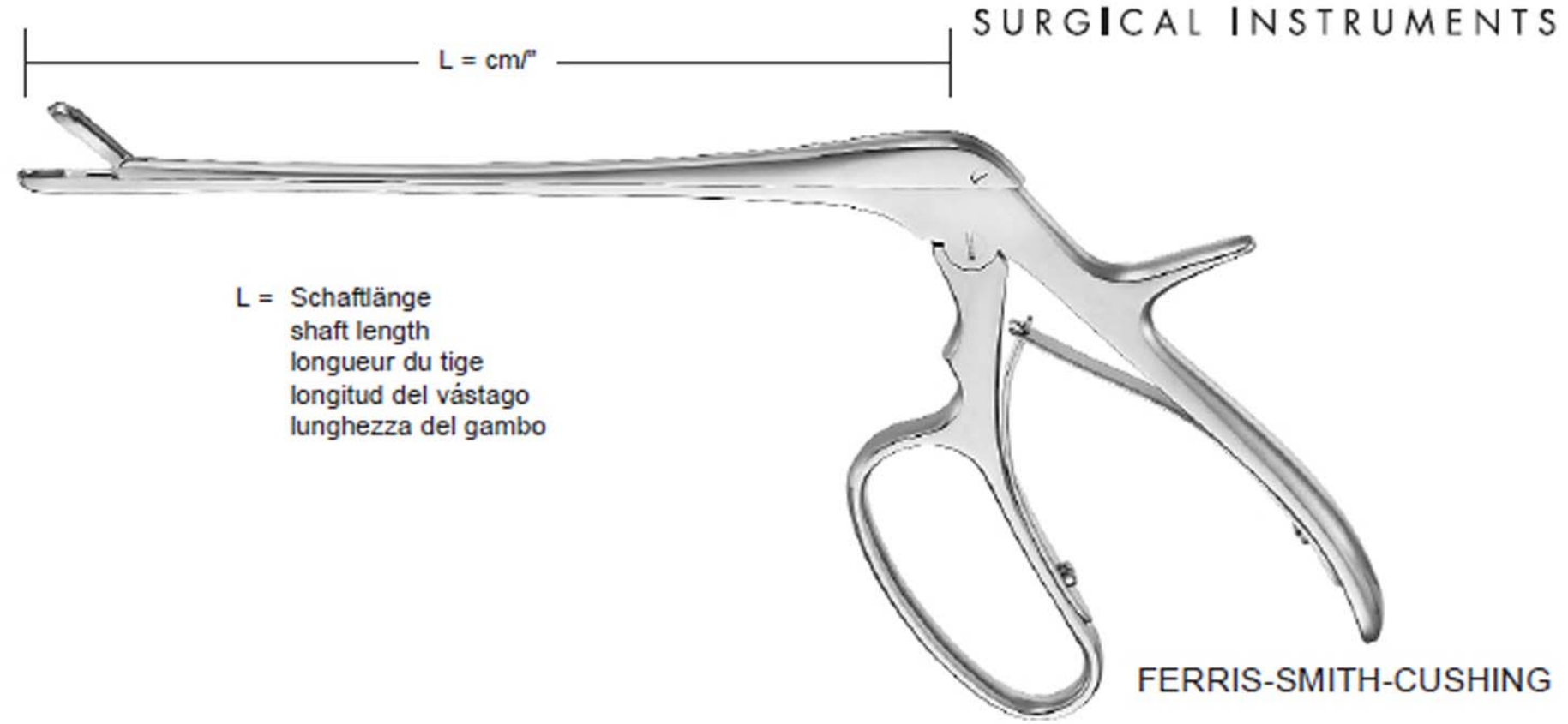

L = Schaftlänge  
shaft length  
longueur du tige  
longitud del vástago  
lunghezza del gambo

FERRIS-SMITH-CUSHING



	16 cm/6¼"	18 cm/7"	16 cm/6¼"	18 cm/7"	16 cm/6¼"	18 cm/7"
2 x 10 mm		40.451.01		40.451.02		40.451.03
3 x 10 mm	40.450.01	40.452.01	40.450.02	40.452.02	40.450.03	40.452.03
4 x 10 mm		40.453.01		40.453.02		40.453.03

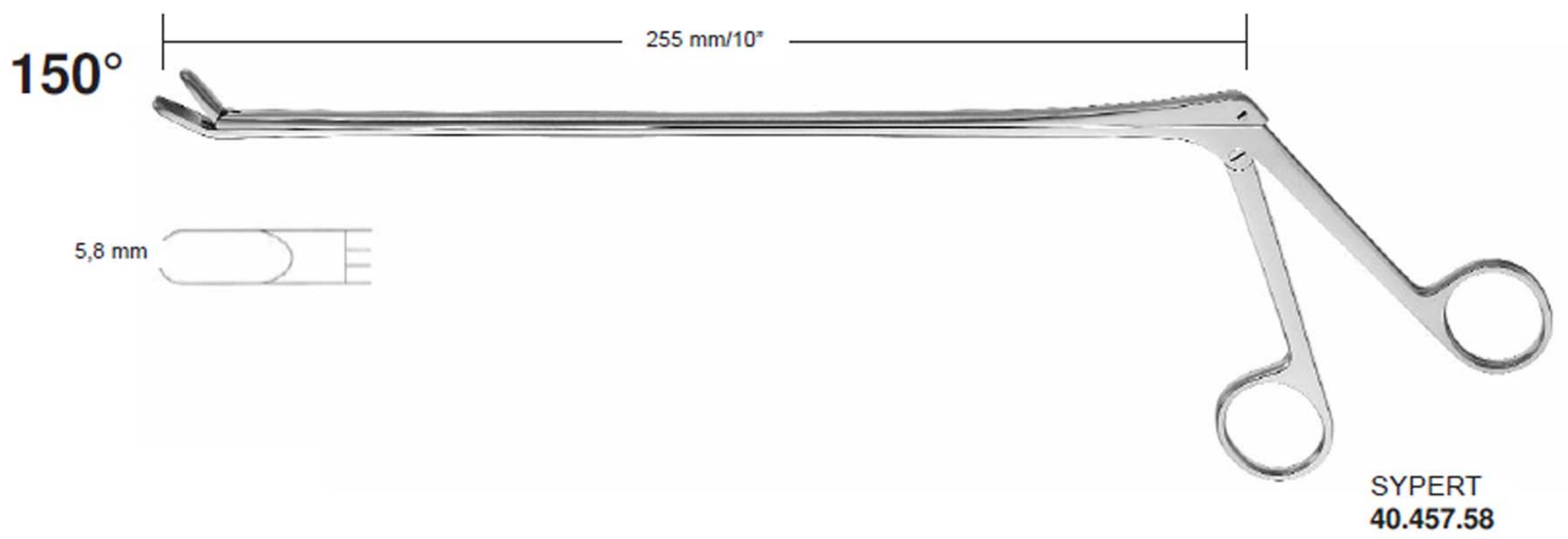
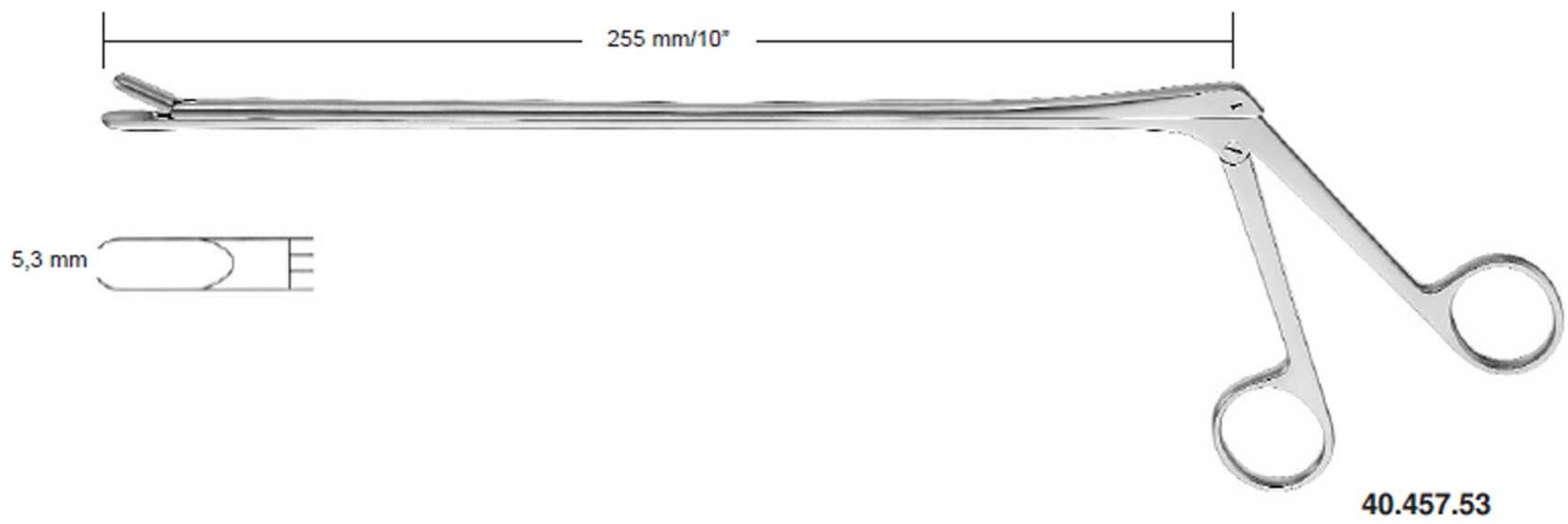

**Neuro Spinal**



SURGICAL INSTRUMENTS

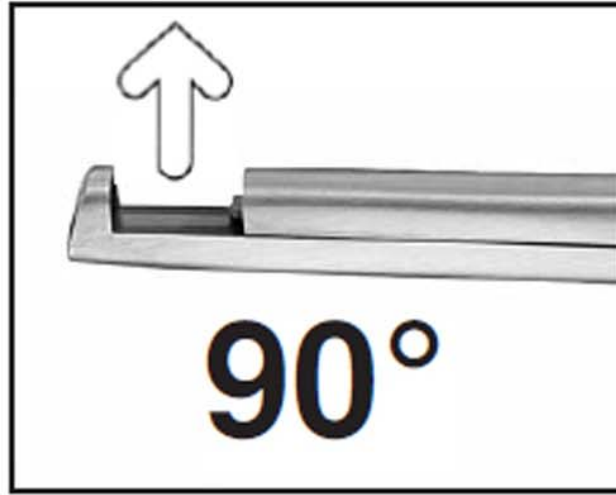

Maul (mm) Jaw Size (mm) mors (mm) boca (mm) morso (mm)	Standard Standard Standard Estándar Standard	Zerlegbar Dismantable Démontable Desmontable Smontabile	Auswerfer Ejector Éjecteur Expulsor Espulsore	Zerlegbar (Keramik) Dismantable (Ceramic) Démontable (Ceramic) Desmontable (Cerámica) Smontabile (Ceramica)	Auswerfer Ejector Éjecteur Expulsor Espulsore
--	--	---	---	---	---

180 mm / 7"	1	40.510.01	40.496.01	-	40.496.01B	-
	2	40.510.02	40.496.02	-	40.496.02B	-
	3	40.510.03	40.496.03	☑	40.496.03B	☑
	4	40.510.04	40.496.04	☑	40.496.04B	☑
	5	40.510.05	40.496.05	☑	40.496.05B	☑
	6	40.510.06	40.496.06	☑	40.496.06B	☑
200 mm / 8"	1	40.510.11	40.496.11	-	40.496.11B	-
	2	40.510.12	40.496.12	-	40.496.12B	-
	3	40.510.13	40.496.13	☑	40.496.13B	☑
	4	40.510.14	40.496.14	☑	40.496.14B	☑
	5	40.510.15	40.496.15	☑	40.496.15B	☑
	6	40.510.16	40.496.16	☑	40.496.16B	☑
230 mm / 9"	1	40.510.21	40.497.02	-	40.497.02B	-
	2	40.510.22	40.497.03	☑	40.497.03B	☑
	3	40.510.23	40.497.04	☑	40.497.04B	☑
	4	40.510.24	40.497.05	☑	40.497.05B	☑
	5	40.510.25	40.497.06	☑	40.497.06B	☑
	6	40.510.26	40.497.06	☑	40.497.06B	☑

dünnfuß thin foot plate	180 mm / 7"	1	40.510.31	40.496.21	-	40.496.21B	-
		2	40.510.32	40.496.22	-	40.496.22B	-
		3	40.510.33	40.496.23	☑	40.496.23B	☑
		4	40.510.34	40.496.24	☑	40.496.24B	☑
		5	40.510.35	40.496.25	☑	40.496.25B	☑
poinçonnage étroite	200 mm / 8"	2	40.510.42	40.496.32	-	40.496.32B	-
		3	40.510.43	40.496.33	☑	40.496.33B	☑
		4	40.510.44	40.496.34	☑	40.496.34B	☑
		5	40.510.45	40.496.35	☑	40.496.35B	☑
punzonar estrecha	230 mm / 9"	2	40.510.52	40.497.12	-	40.497.12B	-
		3	40.510.53	40.497.13	☑	40.497.13B	☑
		4	40.510.54	40.497.14	☑	40.497.14B	☑
		5	40.510.55	40.497.15	☑	40.497.15B	☑
sottile	230 mm / 9"	6	40.510.56	40.497.16	☑	40.497.16B	☑



# MULTICRAFTS Corporation

## SURGICAL INSTRUMENTS

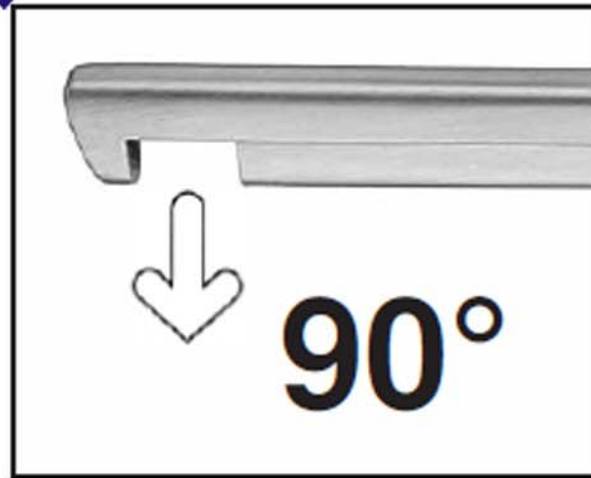

	Maul (mm) Jaw Size (mm) mors (mm) boca (mm) morso (mm)	Standard Standard Standard Estándar Standard	Zerlegbar Dismantable Démontable Desmontable Smontabile	Auswerfer Ejector Éjecteur Expulsor Espulsore	Zerlegbar (Keramik) Dismantable (Ceramic) Démontable (Ceramic) Desmontable (Cerámica) Smontabile (Ceramica)	Auswerfer Ejector Éjecteur Expulsor Espulsore
180 mm / 7"	1	40.511.01	40.498.01	-	40.498.01B	-
	2	40.511.02	40.498.02	-	40.498.02B	-
	3	40.511.03	40.498.03	☑	40.498.03B	☑
	4	40.511.04	40.498.04	☑	40.498.04B	☑
	5	40.511.05	40.498.05	☑	40.498.05B	☑
	6	40.511.06	40.498.06	☑	40.498.06B	☑
200 mm / 8"	1	40.499.11	40.498.11	-	40.498.11B	-
	2	40.499.12	40.498.12	-	40.498.12B	-
	3	40.499.13	40.498.13	☑	40.498.13B	☑
	4	40.499.14	40.498.14	☑	40.498.14B	☑
	5	40.499.15	40.498.15	☑	40.498.15B	☑
	6	40.499.16	40.498.16	☑	40.498.16B	☑
230 mm / 9"	2	40.499.42	40.499.02	-	40.499.02B	-
	3	40.499.43	40.499.03	☑	40.499.03B	☑
	4	40.499.44	40.499.04	☑	40.499.04B	☑
	5	40.499.45	40.499.05	☑	40.499.05B	☑
	6	40.499.46	40.499.06	☑	40.499.06B	☑

dünnfuß thin foot plate	180 mm / 7"	1	40.499.21	40.498.21	-	40.498.21B	-
		2	40.499.22	40.498.22	-	40.498.22B	-
		3	40.499.23	40.498.23	☑	40.498.23B	☑
		4	40.499.24	40.498.24	☑	40.498.24B	☑
		5	40.499.25	40.498.25	☑	40.498.25B	☑
poinçonnage étroite punzónar estrecha	200 mm / 8"	1	40.499.31	40.498.31	-	40.498.31B	-
		2	40.499.32	40.498.32	-	40.498.32B	-
		3	40.499.33	40.498.33	☑	40.498.33B	☑
		4	40.499.34	40.498.34	☑	40.498.34B	☑
		5	40.499.35	40.498.35	☑	40.498.35B	☑
sottile	230 mm / 9"	2	40.499.52	40.498.52	☑	40.498.52B	☑
		3	40.499.53	40.498.53	☑	40.498.53B	☑
		4	40.499.54	40.498.54	☑	40.498.54B	☑
		5	40.499.55	40.498.55	☑	40.498.55B	☑

# Neuro Spinal

SURGICAL INSTRUMENTS

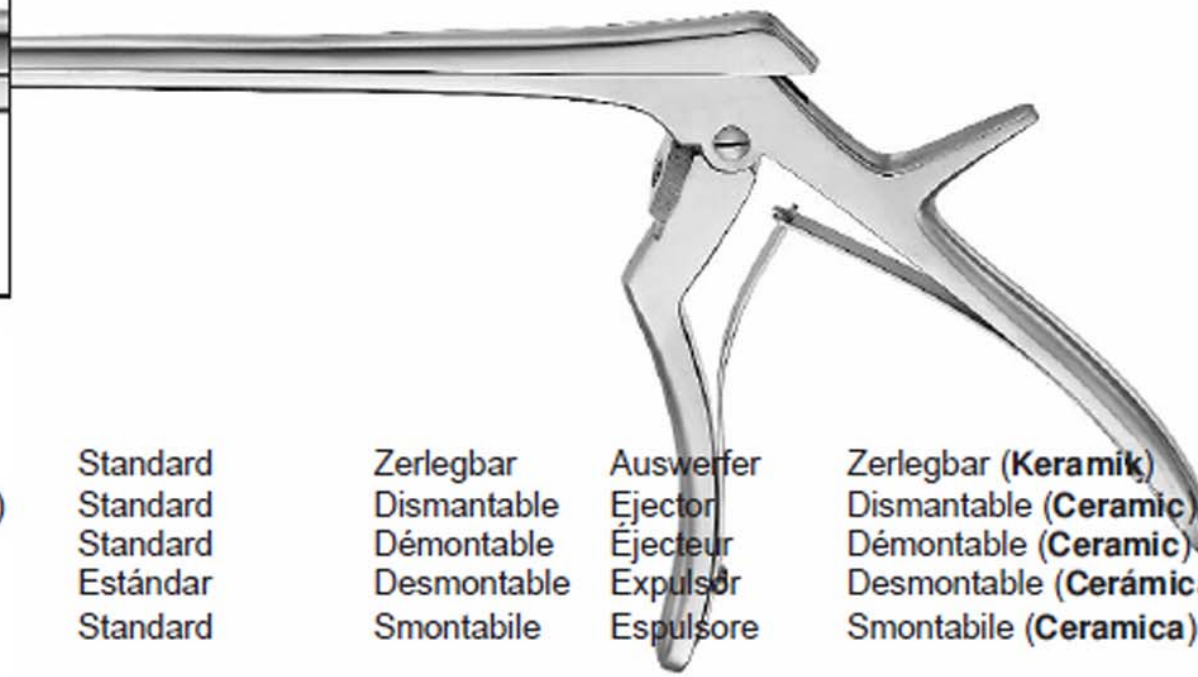
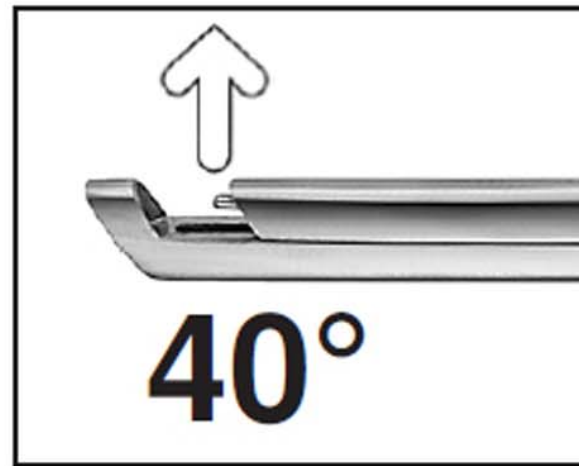

Neuro Spinal

	Maul (mm) Jaw Size (mm) mors (mm) boca (mm) morso (mm)	Standard Standard Standard Estándar Standard	Zerlegbar Dismantable Démontable Desmontable Smontabile	Auswerfer Ejector Éjecteur Expulsor Espulsore	Zerlegbar (Keramik) Dismantable (Ceramic) Démontable (Céramic) Desmontable (Cerámica) Smontabile (Ceramica)	Auswerfer Ejector Éjecteur Expulsor Espulsore
180 mm / 7"	1	40.512.01	40.500.01	-	40.500.01B	-
	2	40.512.02	40.500.02	-	40.500.02B	-
	3	40.512.03	40.500.03	☑	40.500.03B	☑
	4	40.512.04	40.500.04	☑	40.500.04B	☑
	5	40.512.05	40.500.05	☑	40.500.05B	☑
	6	40.512.06	40.500.06	☑	40.500.06B	☑
200 mm / 8"	2	40.511.22	40.501.02	-	40.501.02B	-
	3	40.511.23	40.501.03	☑	40.501.03B	☑
	4	40.511.24	40.501.04	☑	40.501.04B	☑
	5	40.511.25	40.501.05	☑	40.501.05B	☑
	6	40.511.26	40.501.06	☑	40.501.06B	☑
	230 mm / 9"	2	40.542.02	40.502.02	-	40.502.02B
3		40.542.03	40.502.03	☑	40.502.03B	☑
4		40.542.04	40.502.04	☑	40.502.04B	☑
5		40.542.05	40.502.05	☑	40.502.05B	☑
280 mm / 11"	2	40.511.32				
	3	40.511.33				
	4	40.511.34				
	5	40.511.35				
	6	40.511.36				
	180 mm / 7"	1	40.511.11	40.500.11	-	40.500.11B
2		40.511.12	40.500.12	-	40.500.12B	-
3		40.511.13	40.500.13	☑	40.500.13B	☑
4		40.511.14	40.500.14	☑	40.500.14B	☑
5		40.511.15	40.500.15	☑	40.500.15B	☑
200 mm / 8"	1	40.511.41	40.501.11	-	40.501.11B	-
	2	40.511.42	40.501.12	-	40.501.12B	-
	3	40.511.43	40.501.13	☑	40.501.13B	☑
	4	40.511.44	40.501.14	☑	40.501.14B	☑
	5	40.511.45	40.501.15	☑	40.501.15B	☑
230 mm / 9"	2	40.542.12	40.502.12	-	40.502.12B	-
	3	40.542.13	40.502.13	☑	40.502.13B	☑
	4	40.542.14	40.502.14	☑	40.502.14B	☑
	5	40.542.15	40.502.15	☑	40.502.15B	☑

dünnfuß thin foot plate	180 mm / 7"	1	40.511.11	40.500.11	-	40.500.11B	-
		2	40.511.12	40.500.12	-	40.500.12B	-
		3	40.511.13	40.500.13	☑	40.500.13B	☑
		4	40.511.14	40.500.14	☑	40.500.14B	☑
		5	40.511.15	40.500.15	☑	40.500.15B	☑
poinçonnage étroite punzonar estrecha	200 mm / 8"	1	40.511.41	40.501.11	-	40.501.11B	-
		2	40.511.42	40.501.12	-	40.501.12B	-
		3	40.511.43	40.501.13	☑	40.501.13B	☑
		4	40.511.44	40.501.14	☑	40.501.14B	☑
		5	40.511.45	40.501.15	☑	40.501.15B	☑
sottile	230 mm / 9"	2	40.542.12	40.502.12	-	40.502.12B	-
		3	40.542.13	40.502.13	☑	40.502.13B	☑
		4	40.542.14	40.502.14	☑	40.502.14B	☑
		5	40.542.15	40.502.15	☑	40.502.15B	☑



# MULTICRAFTS Corporation

## SURGICAL INSTRUMENTS

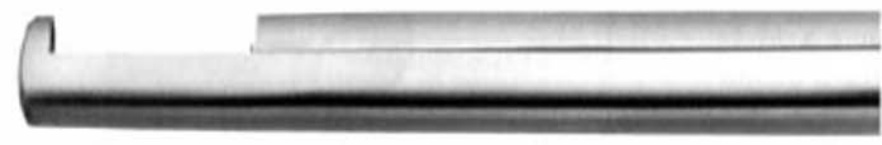
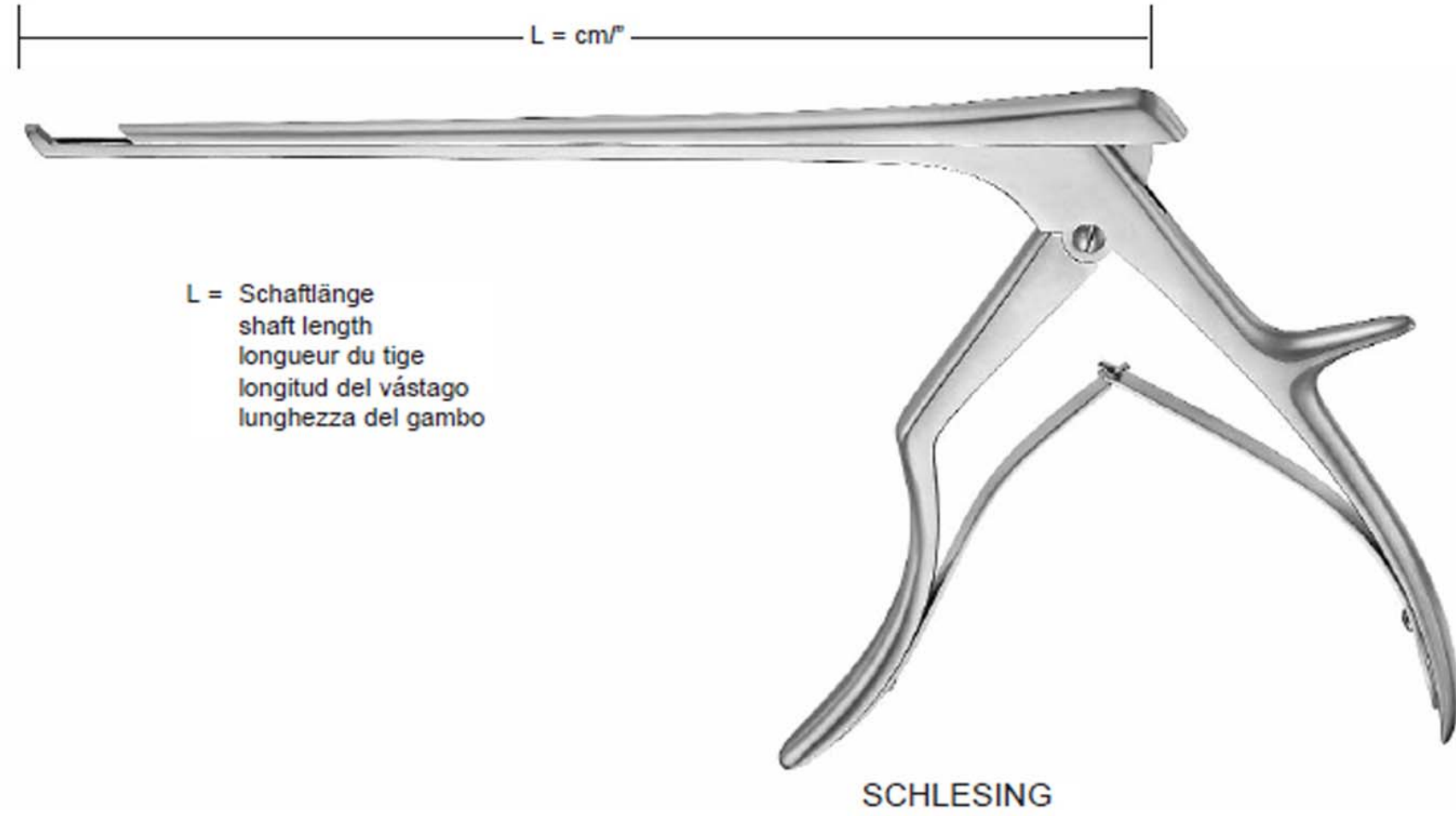

15 cm/6"      20 cm/8"

15 cm/6"      20 cm/8"

3 mm      **40.530.03**      **40.532.03**

5 mm      **40.530.05**      **40.532.05**



15 cm/6"      20 cm/8"

15 cm/6"      20 cm/8"

3 mm      **40.534.03**      **40.536.03**

5 mm      **40.534.05**      **40.536.05**



15 cm/6"      20 cm/8"

3 mm      **40.538.03**      **40.540.03**

5 mm      **40.538.05**      **40.540.05**

**Neuro Spinal**

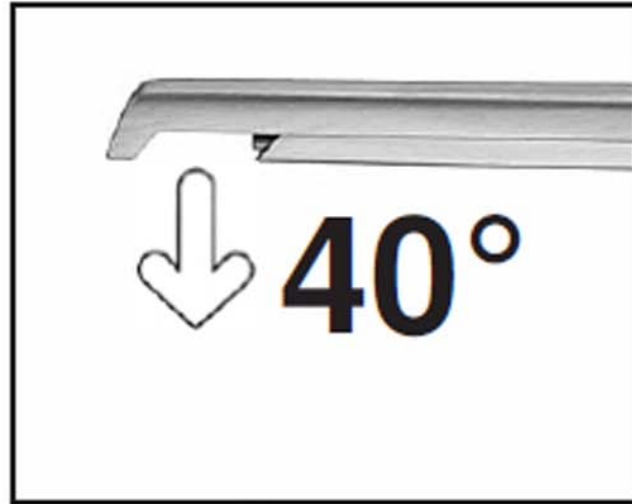

SURGICAL INSTRUMENTS

Maul (mm)	Standard	Zerlegbar	Auswerfer	Zerlegbar (Keramik)	Auswerfer
Jaw Size (mm)	Standard	Dismantable	Ejector	Dismantable (Ceramic)	Ejector
mors (mm)	Standard	Démontable	Ejecteur	Démontable (Ceramic)	Éjecteur
boca (mm)	Estándar	Desmontable	Expulsor	Desmontable (Cerámica)	Expulsor
morso (mm)	Standard	Smontabile	Espulsore	Smontabile (Ceramica)	Espulsore

180 mm / 7"	1	40.514.01	40.503.01	-	40.503.01B	-
	2	40.514.02	40.503.02	-	40.503.02B	-
	3	40.514.03	40.503.03	☑	40.503.03B	☑
	4	40.514.04	40.503.04	☑	40.503.04B	☑
	5	40.514.05	40.503.05	☑	40.503.05B	☑
200 mm / 8"	1	40.514.21	40.503.21	-	40.503.21B	-
	2	40.514.22	40.503.22	-	40.503.22B	-
	3	40.514.23	40.503.23	☑	40.503.23B	☑
	4	40.514.24	40.503.24	☑	40.503.24B	☑
	5	40.514.25	40.503.25	☑	40.503.25B	☑
	6	40.514.26	40.503.26	☑	40.503.26B	☑
230 mm / 9"	2	40.543.02	40.504.02	-	40.504.02B	-
	3	40.543.03	40.504.03	☑	40.504.03B	☑
	4	40.543.04	40.504.04	☑	40.504.04B	☑
	5	40.543.05	40.504.05	☑	40.504.05B	☑
	6	40.543.06	40.504.06	☑	40.504.06B	☑

dünnfuß thin foot plate	180 mm / 7"	1	40.514.11	40.503.11	-	40.503.11B	-
		2	40.514.12	40.503.12	-	40.503.12B	-
		3	40.514.13	40.503.13	☑	40.503.13B	☑
		4	40.514.14	40.503.14	☑	40.503.14B	☑
		5	40.514.15	40.503.15	☑	40.503.15B	☑
poinçonnage étroite punzónar estrecha	200 mm / 8"	1	40.514.31	40.503.31	-	40.503.31B	-
		2	40.514.32	40.503.32	-	40.503.32B	-
		3	40.514.33	40.503.33	☑	40.503.33B	☑
		4	40.514.34	40.503.34	☑	40.503.34B	☑
		5	40.514.35	40.503.35	☑	40.503.35B	☑
sottile	230 mm / 9"	2	40.543.12	40.504.12	-	40.504.12B	-
		3	40.543.13	40.504.13	☑	40.504.13B	☑
		4	40.543.14	40.504.14	☑	40.504.14B	☑
		5	40.543.15	40.504.15	☑	40.504.15B	☑



# MULTICRAFTS Corporation

## SURGICAL INSTRUMENTS

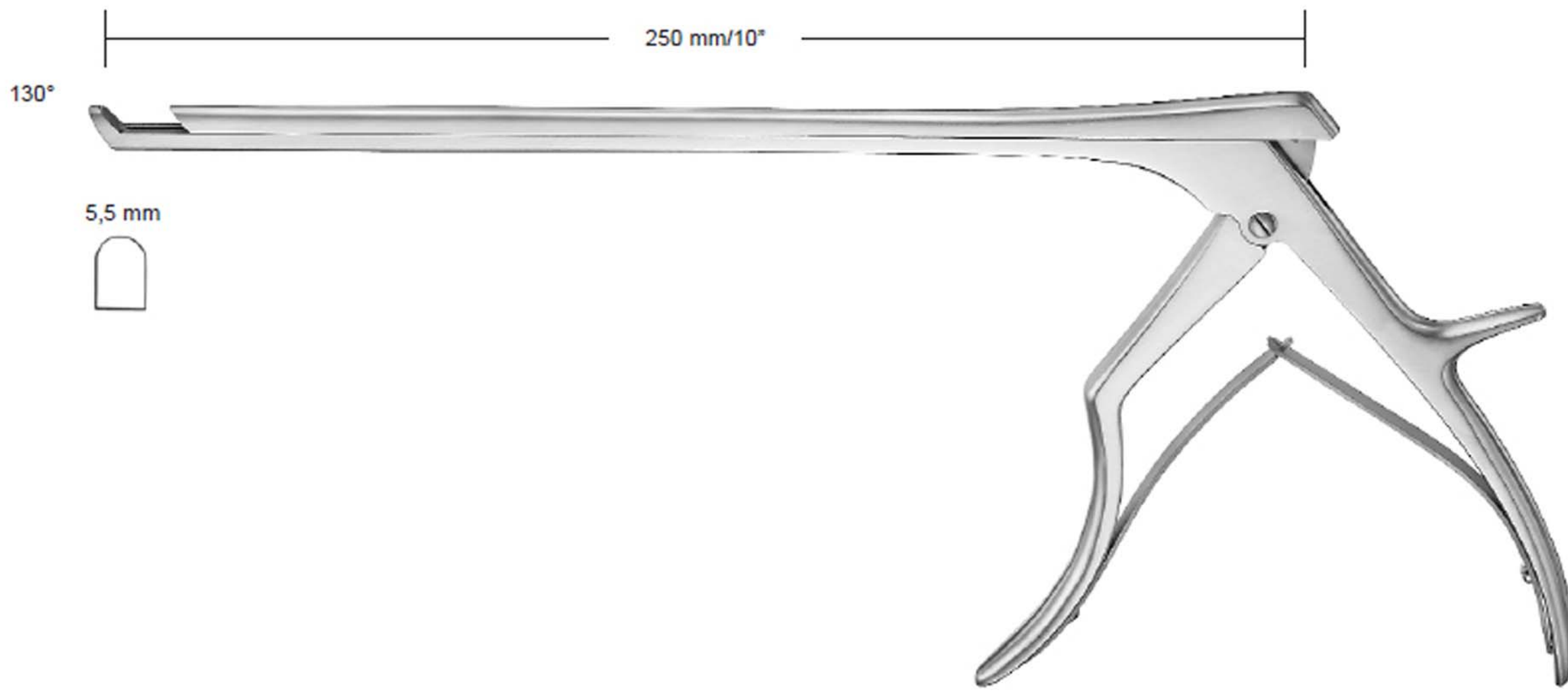

SYPERT  
40.546.55

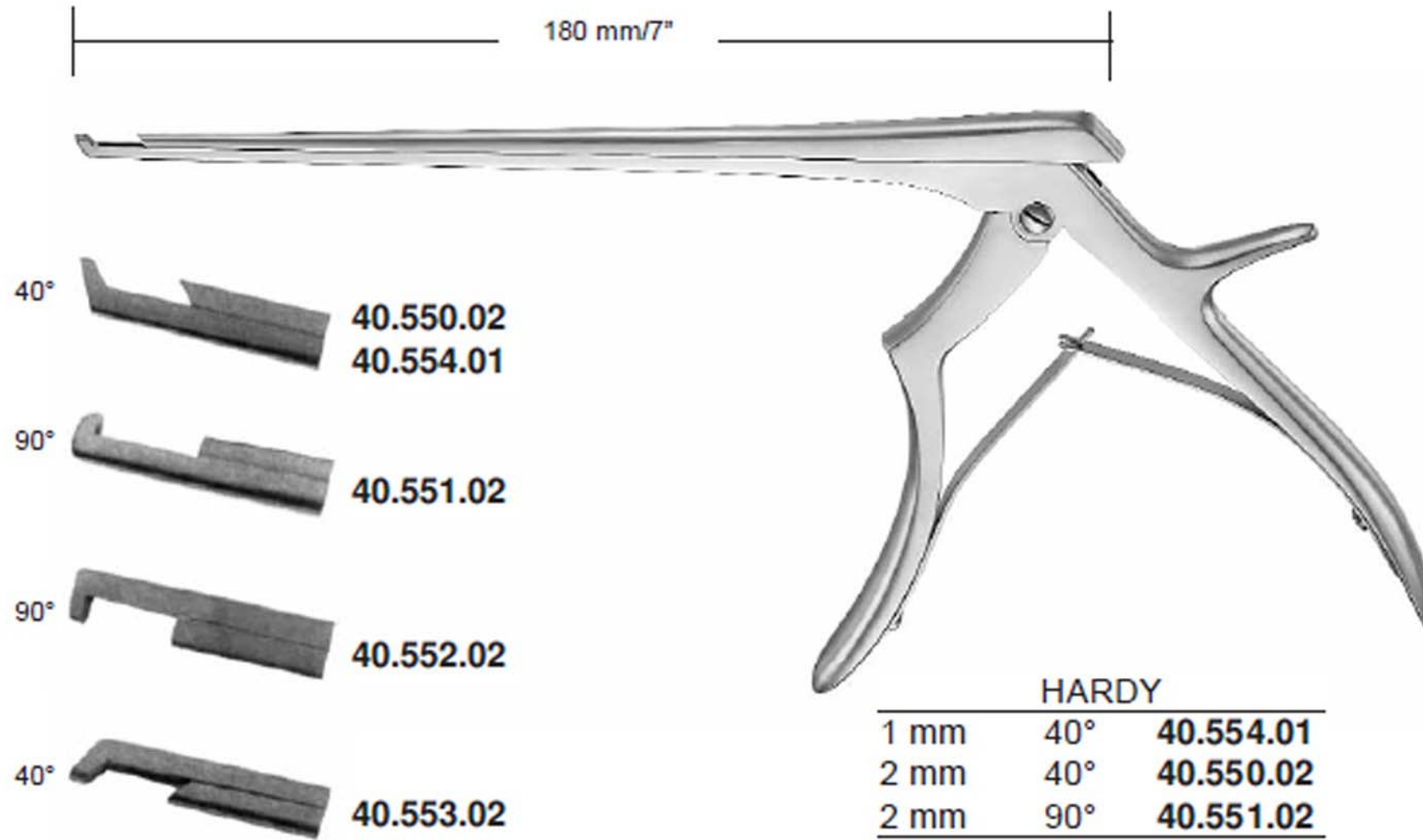

HARDY		
1 mm	40°	40.554.01
2 mm	40°	40.550.02
2 mm	90°	40.551.02
2 mm	90°	40.552.02
2 mm	40°	40.553.02

# Neuro Spinal



### SURGICAL INSTRUMENTS

oben schneidend  
up cutting  
tranchant en haut  
cortante por arriba  
tagliente in alto

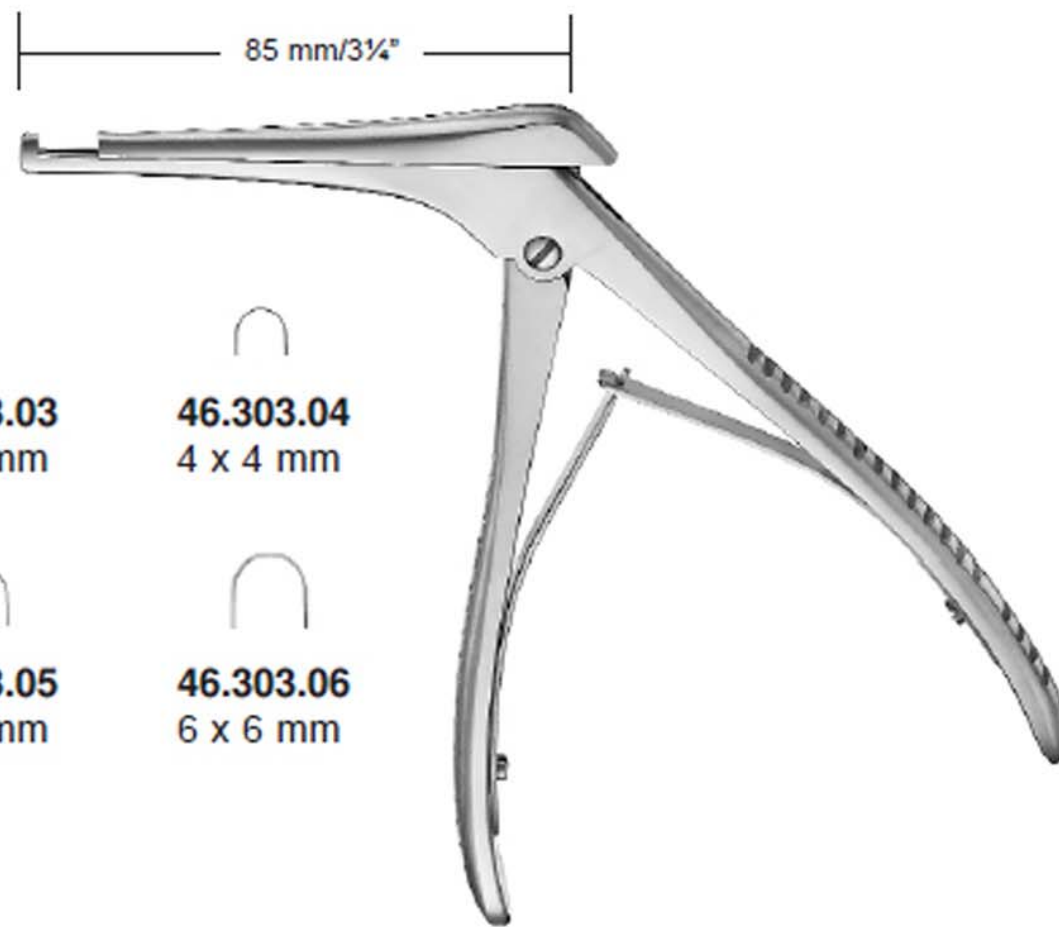

- 46.303.03 3 x 3 mm
- 46.303.04 4 x 4 mm
- 46.303.05 5 x 5 mm
- 46.303.06 6 x 6 mm

**KERRISON**  
17 cm/6 3/4"



**CITELLI**  
1,0 mm **46.311.10**  
2,5 mm **46.311.25**  
4,0 mm **46.311.40**

Keilbeinstanzen  
Sphenoid Bone Punches  
Pinces emporte-pièces pour sinus sphénoïdal  
Pinzas sacabocadas para esfenoïdes  
Pinze taglianti per seno sfenoïdale

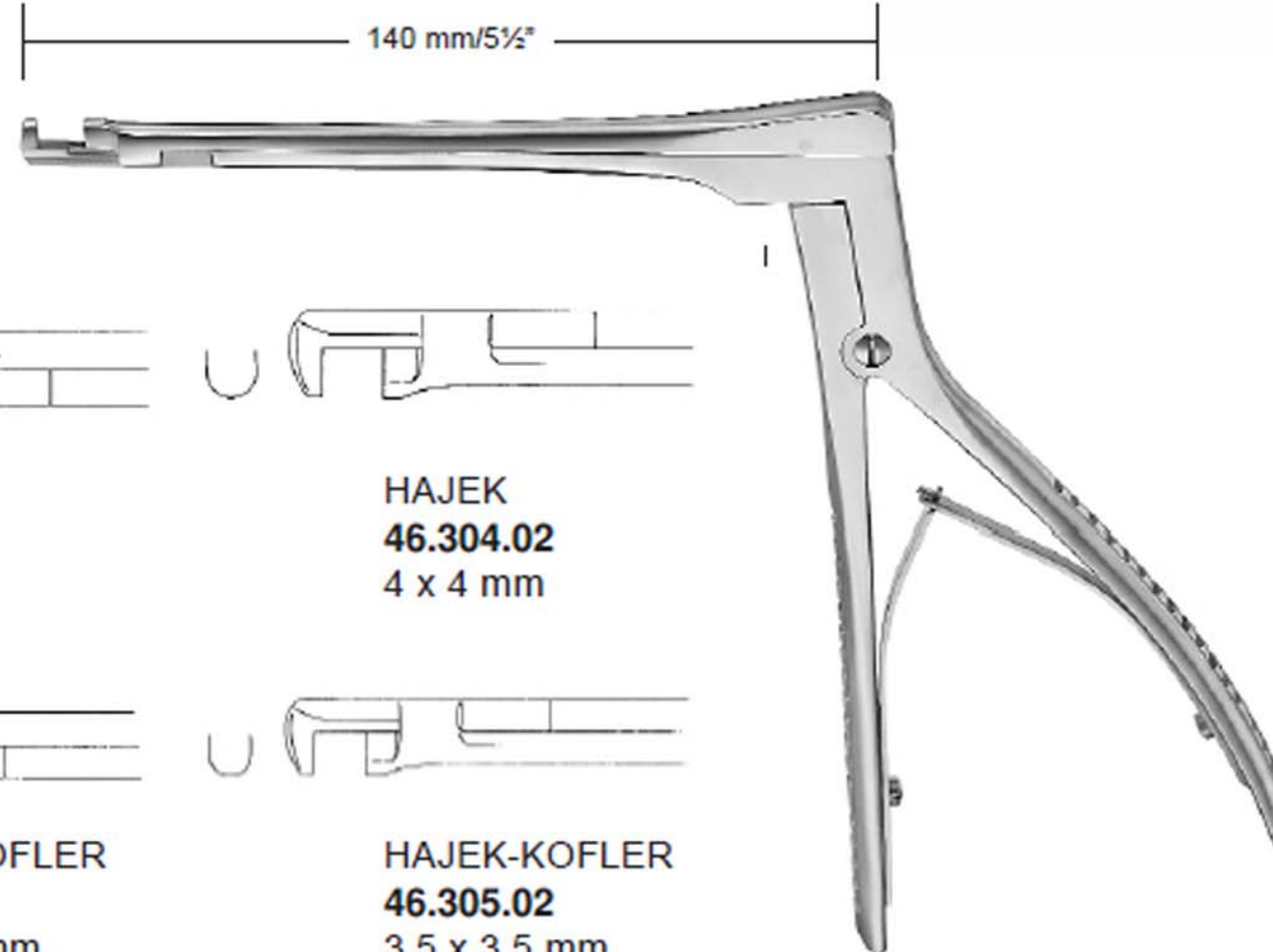

**BEYER**  
46.315.20

- HAJEK **46.304.01** 4 x 4 mm
- HAJEK **46.304.02** 4 x 4 mm
- HAJEK-KOFLER **46.305.01** 3,5 x 3,5 mm
- HAJEK-KOFLER **46.305.02** 3,5 x 3,5 mm



# MULTICRAFTS Corporation

## SURGICAL INSTRUMENTS

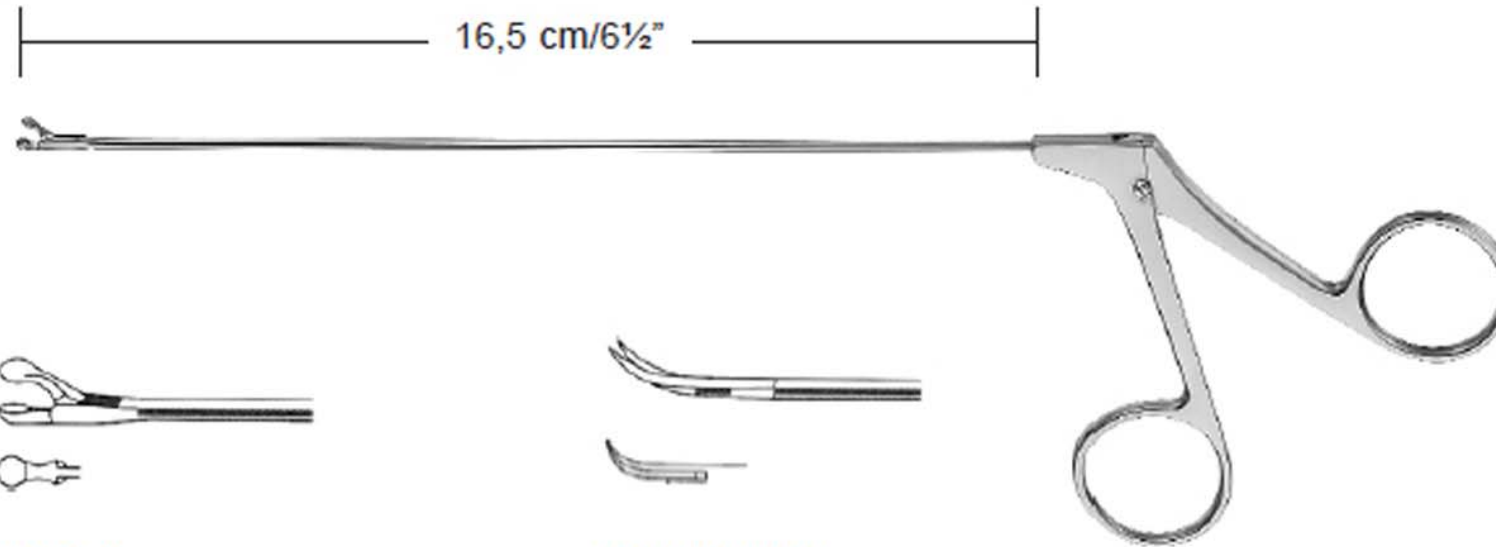

**NICOLA**  
**40.882.16**  
Ø 2,5 mm

Scharfezange mit löffelförmigem Maul  
Forceps, scoop-shaped  
pince, en forme de cuillère  
pinza, en forma de cuchara  
pinze, a forma di cucchiaio

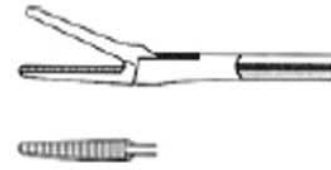

**YASARGIL-NICOLA**  
**40.886.16**

Faßzange mit feinem Maul  
Forceps, long conical jaws  
pince, conique long mâchoires  
pinza, cónico largo mandíbulas  
pinze, lungo conico mascelle

**FAHLBUSCH**  
**40.881.16**

Schere, horizontal schneidend  
Schere, horizontal cutting, curved on flat  
Ciseaux, coupe horizontale  
Tijeras, corte horizontal  
Forbici, taglio orizzontale



**NICOLA**  
**40.884.16**

Schere, gerade  
Scissors, straight  
Ciseaux, droit  
Tijeras, recta  
Forbici, diritta

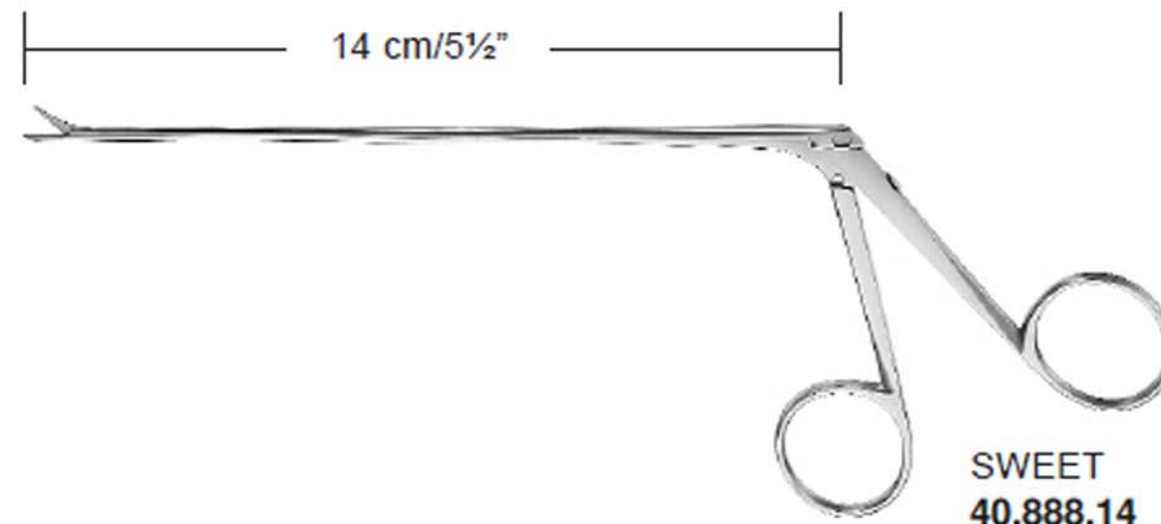

**SWEET**  
**40.888.14**  
10 mm



**40.892.14**  
5 mm  
gerade  
Straight  
droite  
recta  
diritta

**40.893.14**  
5 mm  
links gebogen  
left curved  
courbe à gauche  
curvo izquierda  
curvo sinistro

**40.895.14**  
5 mm  
rechts gebogen  
right curved  
courbe à droite  
curvo derecho  
curvo destro

**DECKER**

# Neuro Spinal





# MULTICRAFTS Corporation

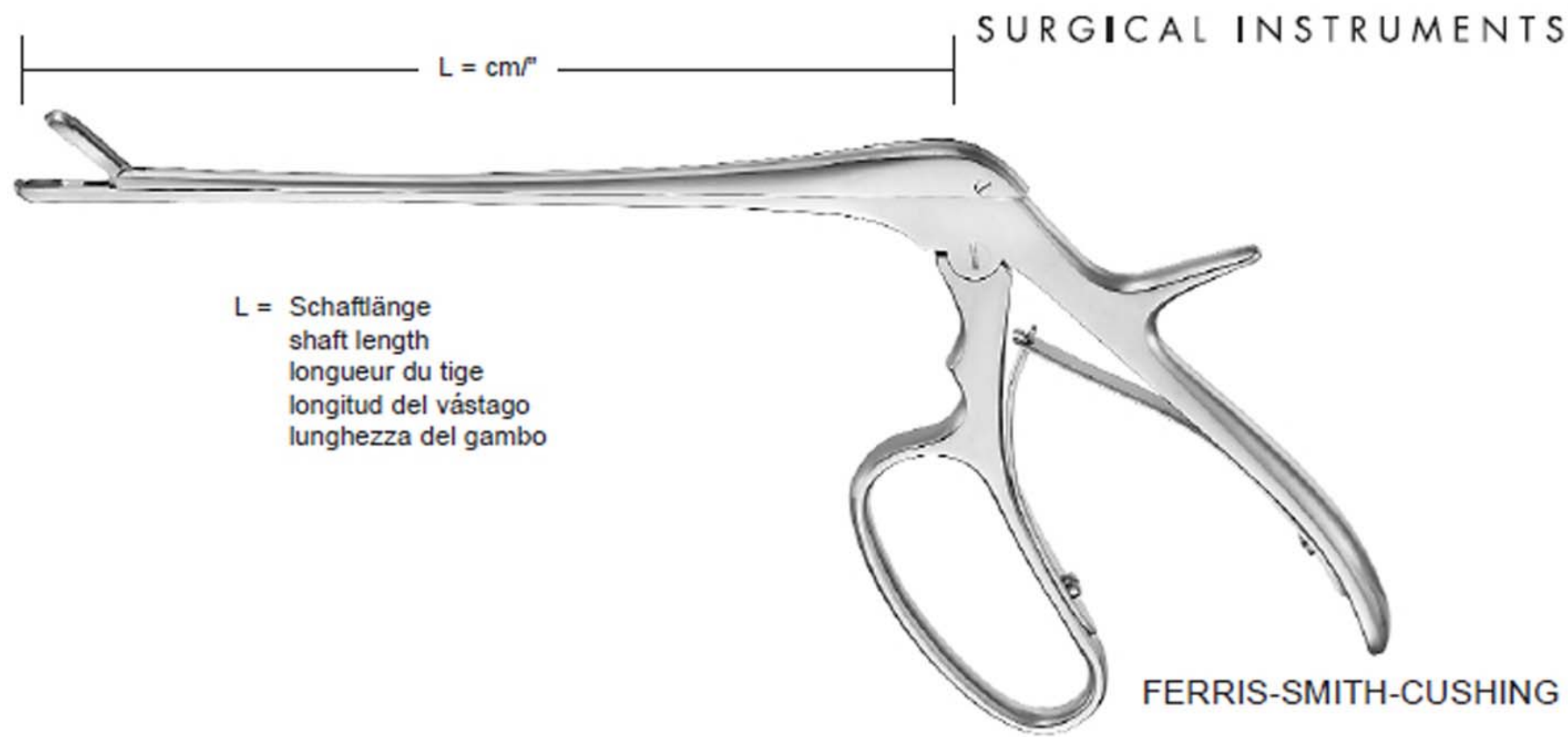

FERRIS-SMITH-CUSHING



	16 cm/6¼"	18 cm/7"	16 cm/6¼"	18 cm/7"	16 cm/6¼"	18 cm/7"
2 x 10 mm		40.451.01		40.451.02		40.451.03
3 x 10 mm	40.450.01	40.452.01	40.450.02	40.452.02	40.450.03	40.452.03
4 x 10 mm		40.453.01		40.453.02		40.453.03

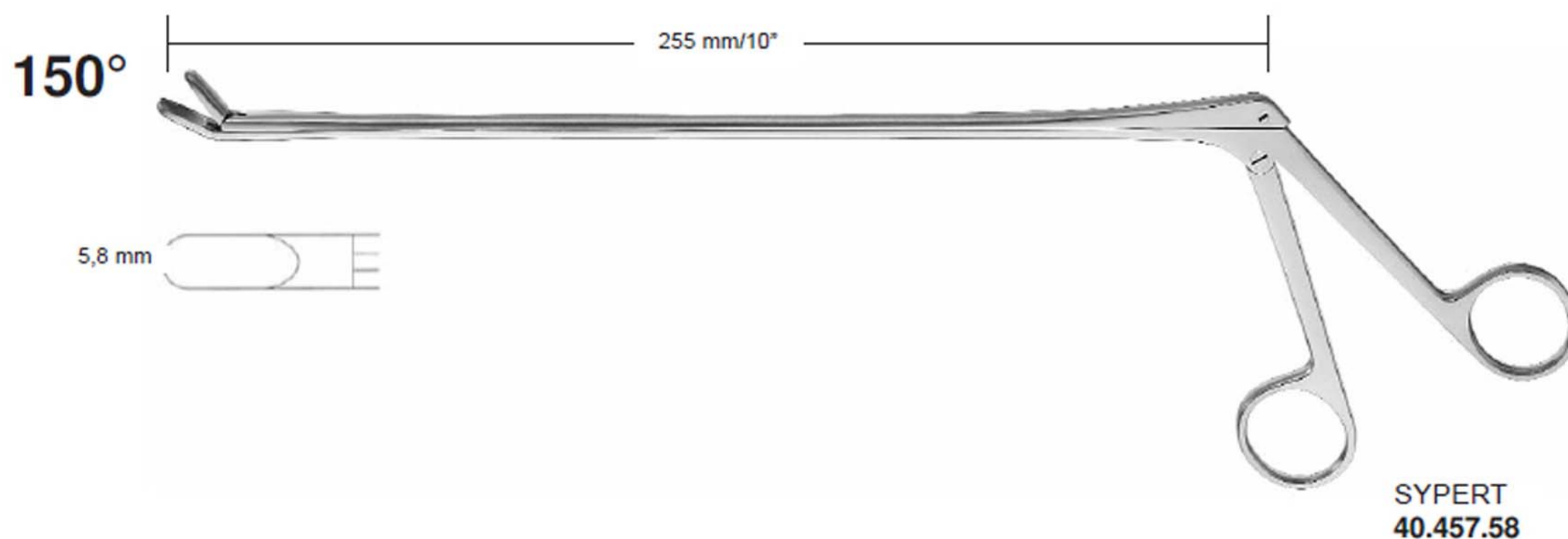
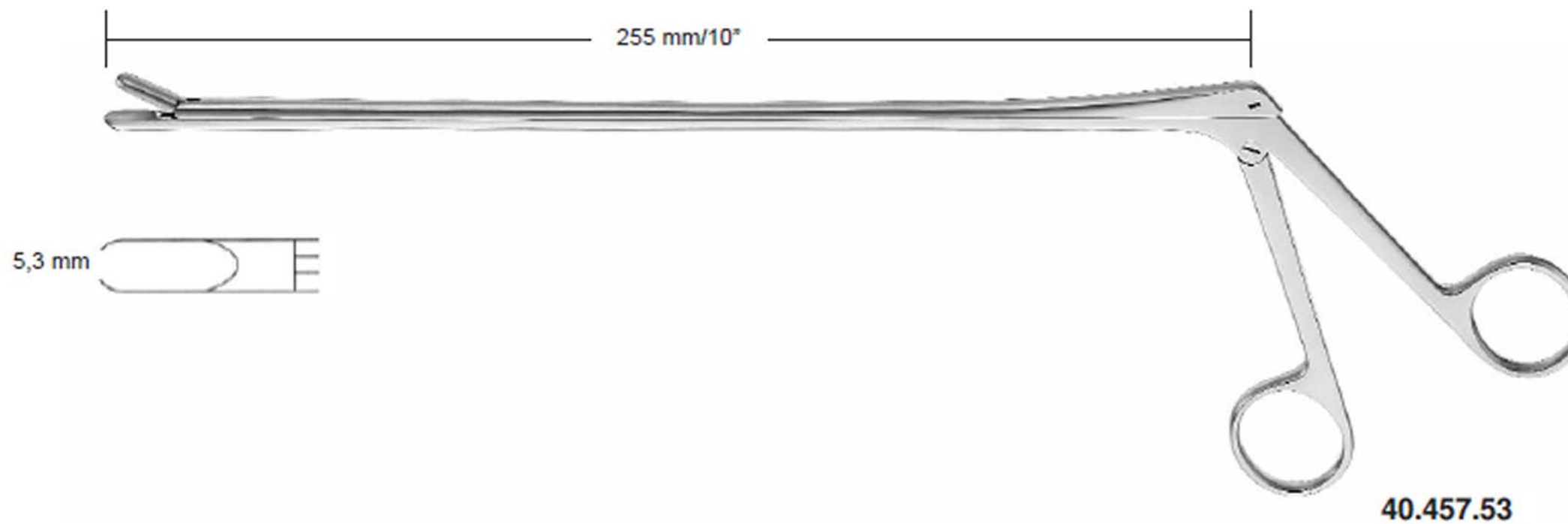

# Neuro Spinal



# MULTICRAFTS Corporation

## SURGICAL INSTRUMENTS

# Neuro Spinal

gerade  
straight  
droite  
recta  
diritta

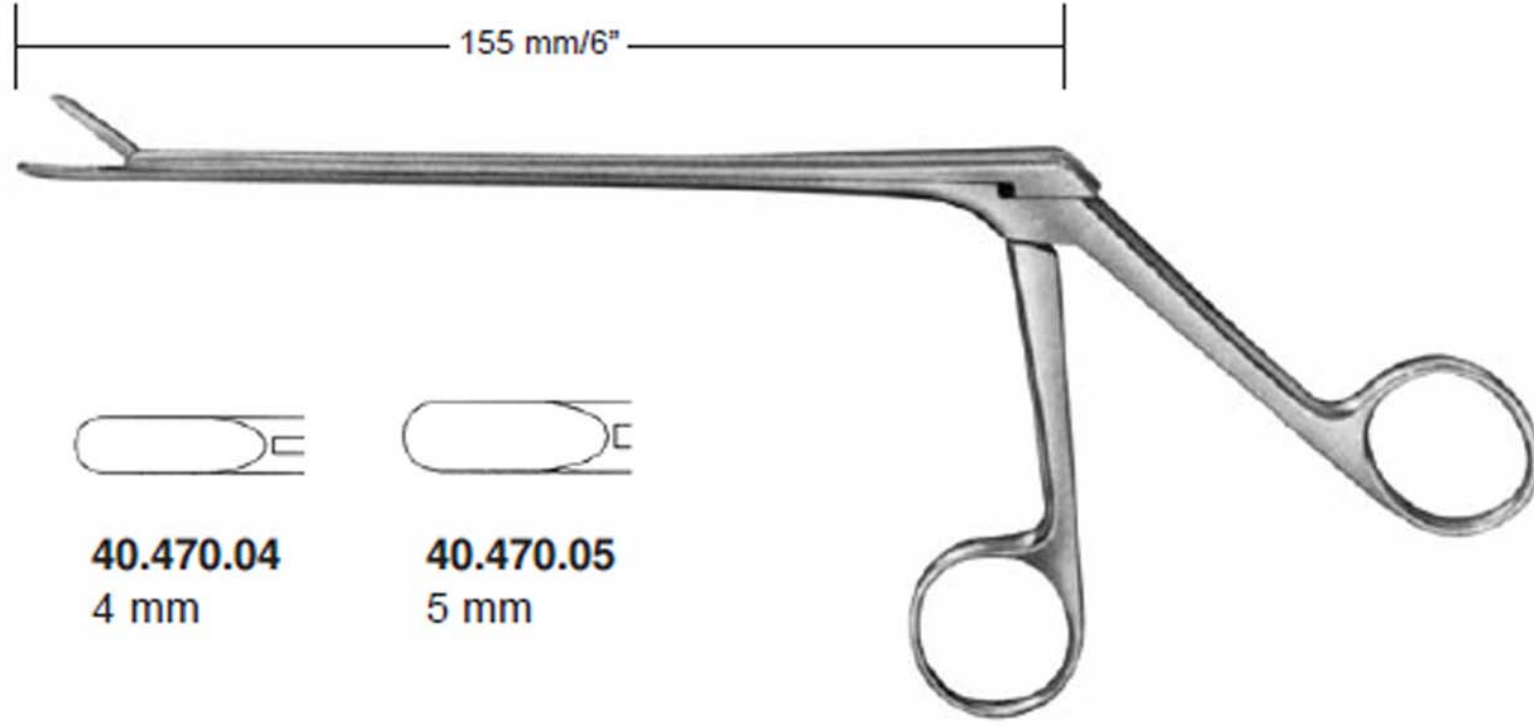



- |   |   |   |   |
|---|---|---|---|
|  |  |  |  |
| <b>40.470.02</b><br>2 mm  | <b>40.470.03</b><br>3 mm  | <b>40.470.04</b><br>4 mm  | <b>40.470.05</b><br>5 mm  |

CASPAR

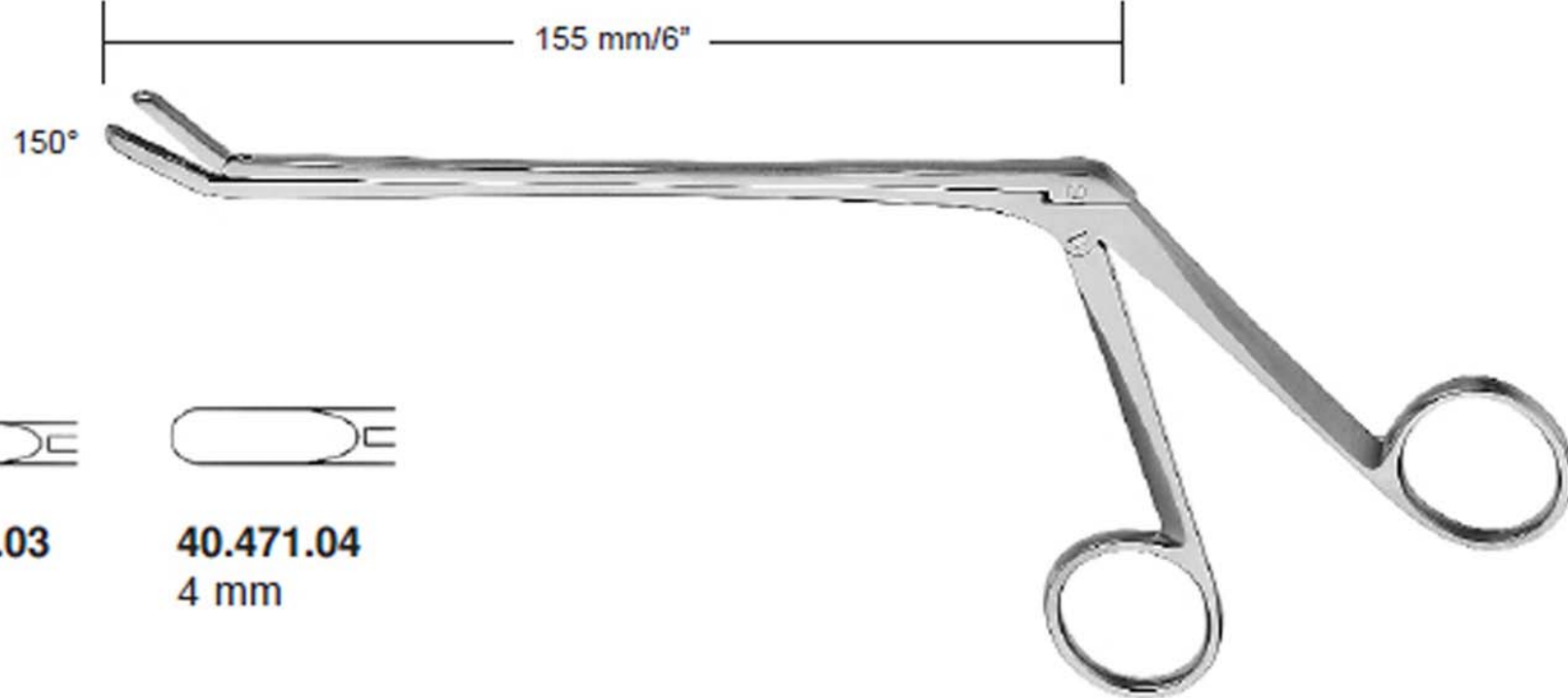
nach oben  
upwards  
vers le haut  
hacia arriba  
in alto

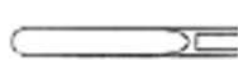

- |   |   |   |
|---|---|---|
|  |  |  |
| <b>40.471.02</b><br>2 mm  | <b>40.471.03</b><br>3 mm  | <b>40.471.04</b><br>4 mm  |

CASPAR

nach unten  
downwards  
vers le bas  
hacia abajo  
in basso

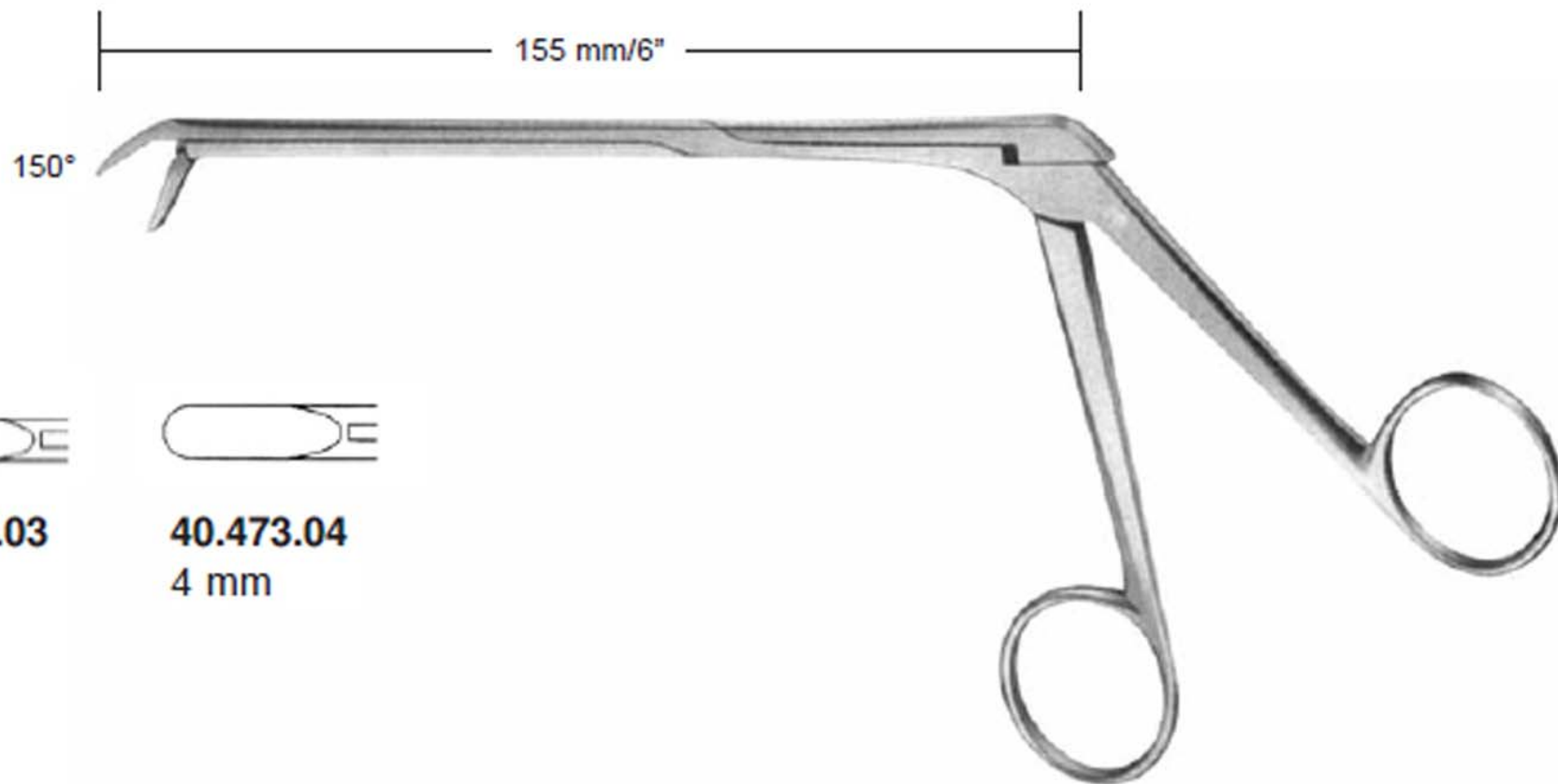

- |   |   |   |
|---|---|---|
|  |  |  |
| <b>40.473.02</b><br>2 mm  | <b>40.473.03</b><br>3 mm  | <b>40.473.04</b><br>4 mm  |

CASPAR



## SURGICAL INSTRUMENTS



CASPAR  
15 cm/6"

90 mm



CASPAR  
16,5 cm/6½"

**18.720.00**

Gegensperrer komplett,  
für ventrale cervicale Fusionsoperationen,  
mit 5 Blättern 18.716.45 - 18.716.65

Retractor complete,  
for ventral cervical fusion operations  
with 5 blades 18.716.45 - 18.716.65

Ecarteurs complet,  
chacun avec deux valves interchangeables  
avec 5 valves 18.716.45 - 18.716.65

Separadores completo,  
con 5 valvas enchufables de c.u. 18.716.45 - 18.716.65

Divaricatori completo,  
con 5 valve ad innesto 18.716.45 - 18.716.65



18.716.45 - 18.716.65

**18.720.15**

Sperrer allein  
Spreader only  
Ecarteur seul  
Separador suelto  
Divaricatore solo

**18.721.00**

Gegensperrer komplett,  
für ventrale cervicale Fusionsoperationen,  
mit 5 Blättern 18.716.45 - 18.716.65

Retractor complete,  
for ventral cervical fusion operations  
with 5 blades 18.716.45 - 18.716.65

Ecarteurs complet,  
chacun avec deux valves interchangeables  
avec 5 valves 18.716.45 - 18.716.65

Separadores completo,  
con 5 valvas enchufables de c.u. 18.716.45 - 18.716.65

Divaricatori completo,  
con 5 valve ad innesto 18.716.45 - 18.716.65



18.716.45 - 18.716.65

**18.721.15**

Sperrer allein  
Spreader only  
Ecarteur seul  
Separador suelto  
Divaricatore solo



# MULTICRAFTS Corporation

## SURGICAL INSTRUMENTS

# Neuro Spinal

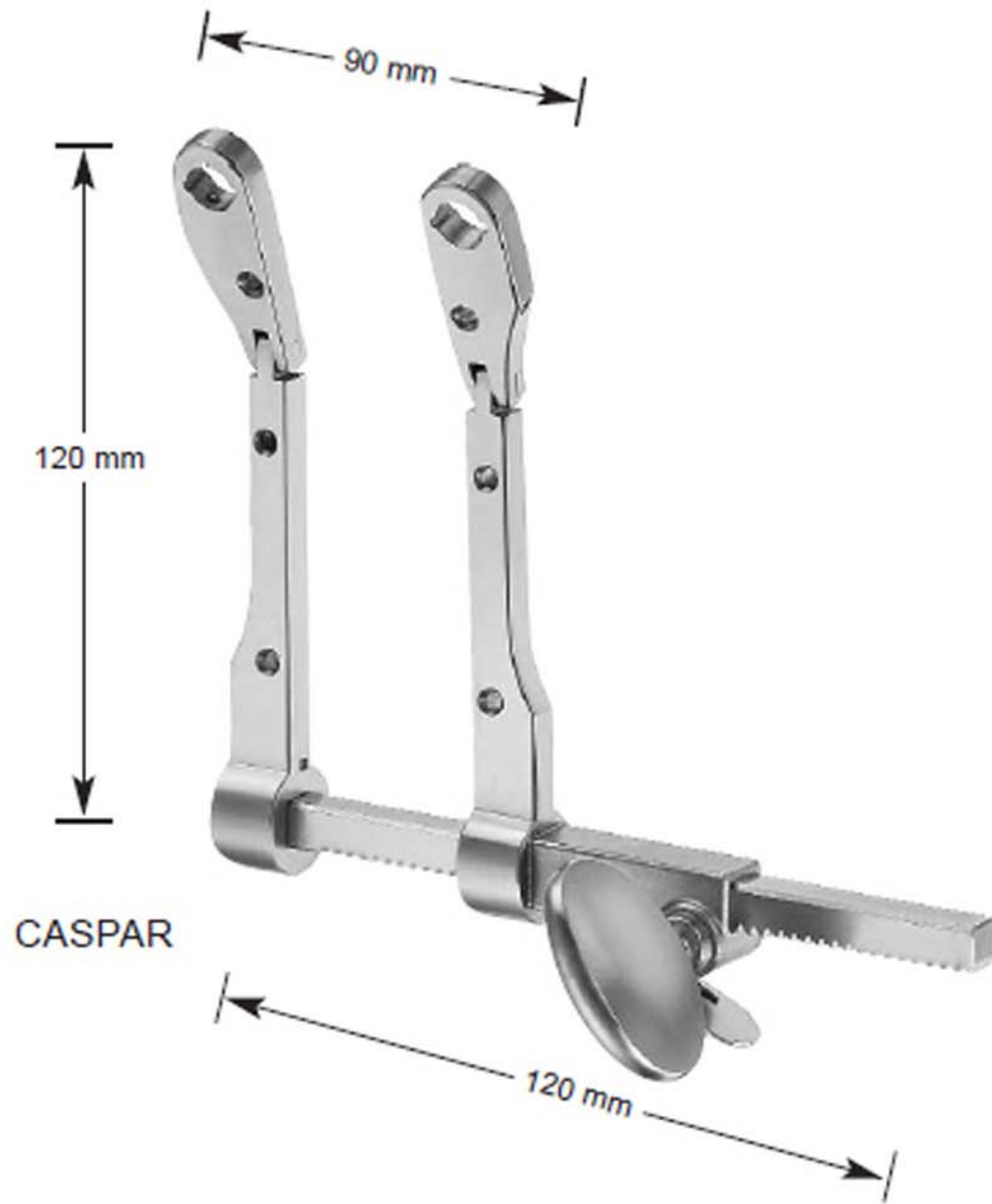

**18.723.00**

Sperrer komplett mit  
5 medialen Blättern 18.718.40 - 18.718.60  
5 lateralen Blättern 18.719.40 - 18.719.60

Retractor complete with  
5 medial blades 18.718.40 - 18.718.60  
5 lateral blades 18.719.40 - 18.719.60

Ecarteurs complet avec  
5 médial valves 18.718.40 - 18.718.60  
5 latéral valves 18.719.40 - 18.719.60

Separadores completo con  
5 medial valvas 18.718.40 - 18.718.60  
5 lateral valvas 18.719.40 - 18.719.60

Divaricatori completo con  
5 media valve 18.718.40 - 18.718.60  
5 laterale valve 18.719.40 - 18.719.60

**18.723.12**

Sperrer allein  
Spreader only  
Ecarteur seul  
Separador suelto  
Divaricatore solo



18.718.40 - 18.718.60



18.719.40 - 18.719.60

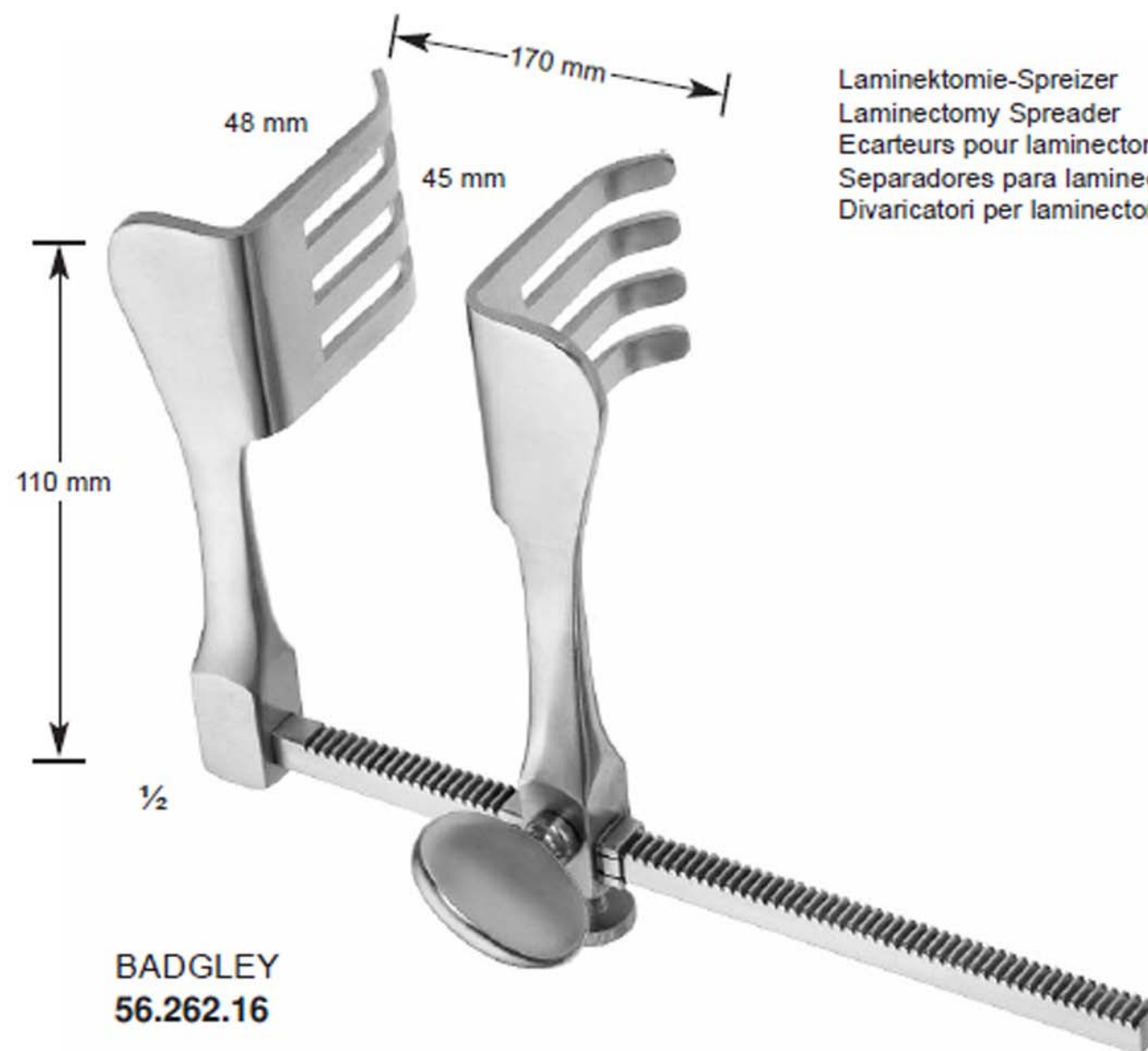

Laminektomie-Spreizer  
Laminectomy Spreader  
Ecarteurs pour laminectomie  
Separadores para laminectomia  
Divaricatori per laminectomia

**BADGLEY**  
**56.262.16**



# MULTICRAFTS Corporation

## SURGICAL INSTRUMENTS

CASPAR  
18.736.01

Distraktor allein  
Distractor only  
DISTRACTEUR seulement  
Distractor sólo  
Distractor solo



CASPAR  
18.736.00

Wirbelkörperdistraktor, für Eingriffe mittels rechtsseitigem Zugang zu C5 - T½ und linksseitigem Zugang zur oberen HWS, bestehend aus:

- 18.736.01 1 Distraktor allein
- 18.736.02 1 Bohrlehre
- 18.736.10 1 Bohrer
- 18.736.16 2 Distraktionsschrauben
- 18.736.10 1 Schraubendreher

Vertebral body distractor, for use in surgical procedures from **the right** approach for C 5 through T½ and from **the left** approach for the upper cervical spine, consisting of:

- 18.736.01 1 Distractor only
- 18.736.02 1 Drill guide
- 18.736.10 1 Twist Drill
- 18.736.16 2 Distraction Screws
- 18.736.10 1 Screw driver



CASPAR  
18.737.01

Distraktor allein  
Distractor only  
DISTRACTEUR seulement  
Distractor sólo  
Distractor solo

CASPAR  
18.737.00

Wirbelkörperdistraktor, für Eingriffe mittels linksseitigem Zugang zu C5 - T½ und linksseitigem Zugang zur oberen HWS, bestehend aus:

- 18.737.01 1 Distraktor allein
- 18.737.02 1 Bohrlehre
- 18.736.10 1 Bohrer
- 18.736.16 2 Distraktionsschrauben
- 18.736.10 1 Schraubendreher

Vertebral body distractor, for use in surgical procedures from **the left** approach for C 5 through T½ and from **the left** approach for the upper cervical spine, consisting of:

- 18.737.01 1 Distractor only
- 18.737.02 1 Drill guide
- 18.736.10 1 Twist Drill
- 18.736.16 2 Distraction Screws
- 18.736.10 1 Screw driver

DISTRACTEUR corps vertébral, pour utilisation dans des interventions chirurgicales à partir de la gauche approche de C 5 à T½ et de la gauche approche de la colonne cervicale supérieure, composée de:

- 18.737.01 1 distracteur seul
- 18.737.02 1 guide-meche
- 18.736.10 1 meche
- 18.736.16 2 vis a distraction
- 18.736.10 1 tournevis

# Neuro Spinal



# MULTICRAFTS Corporation

## Neuro Spinal

### SURGICAL INSTRUMENTS

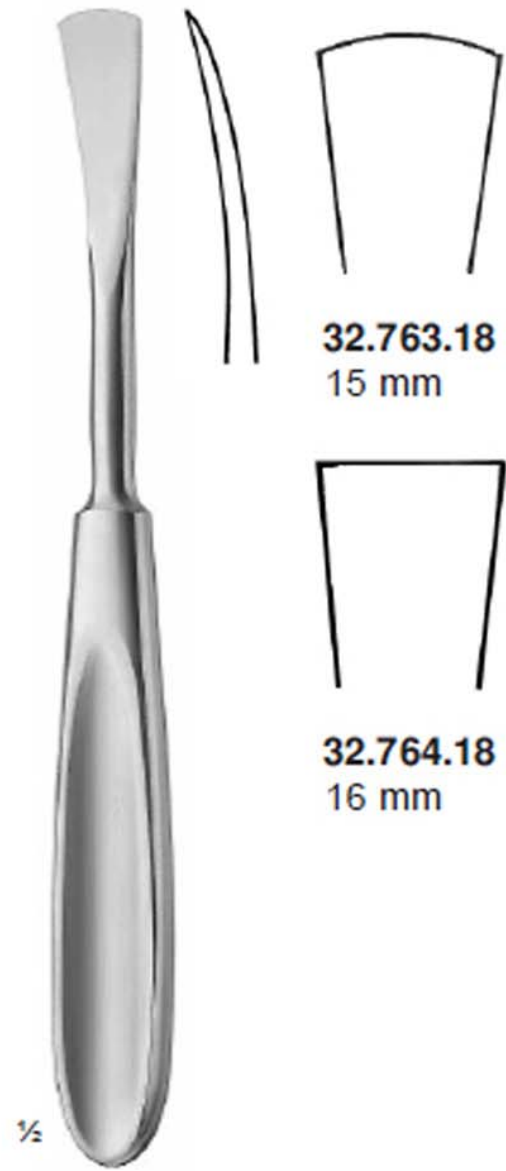

CUSHING  
18 cm/7"

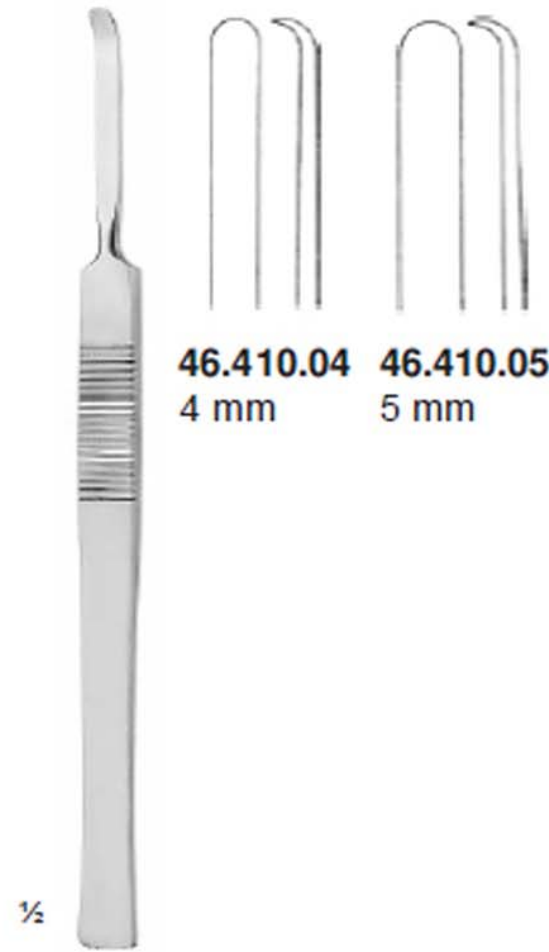

McKENTY  
15 cm/6"



SEWALL  
46.436.20  
20 cm/8"

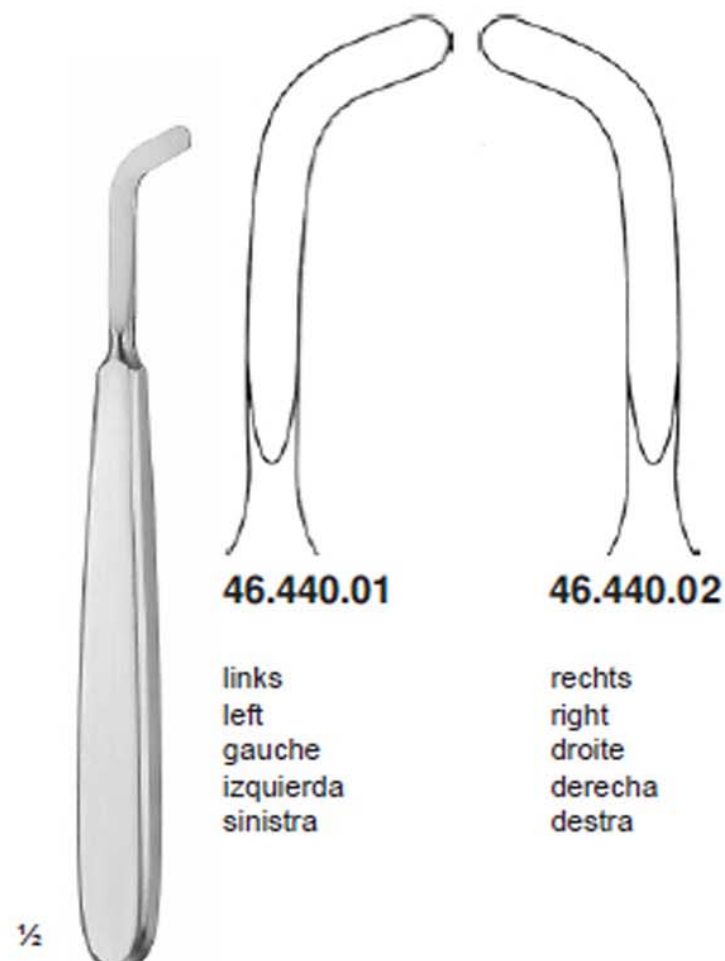

14 cm/5½"

46.440.01

links  
left  
gauche  
izquierda  
sinistra

46.440.02

rechts  
right  
droite  
derecha  
destra



WILLIGER  
82.897.13  
13 cm/5"

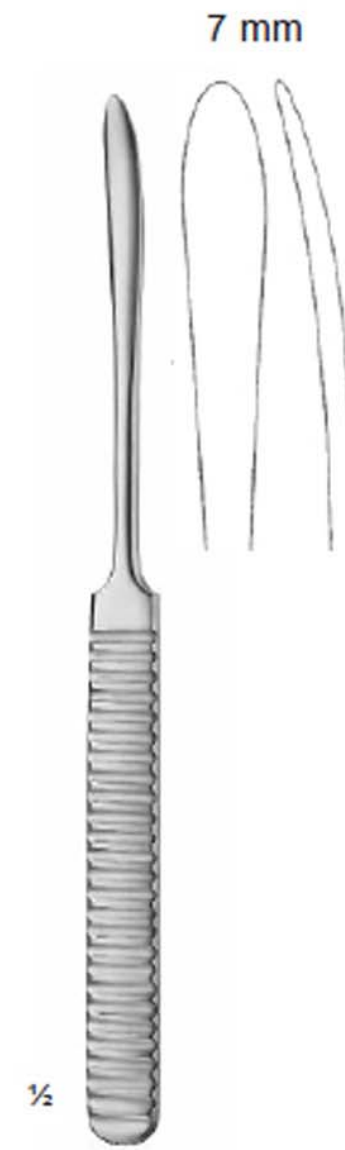

WILLIGER  
82.898.17  
17 cm/6¾"

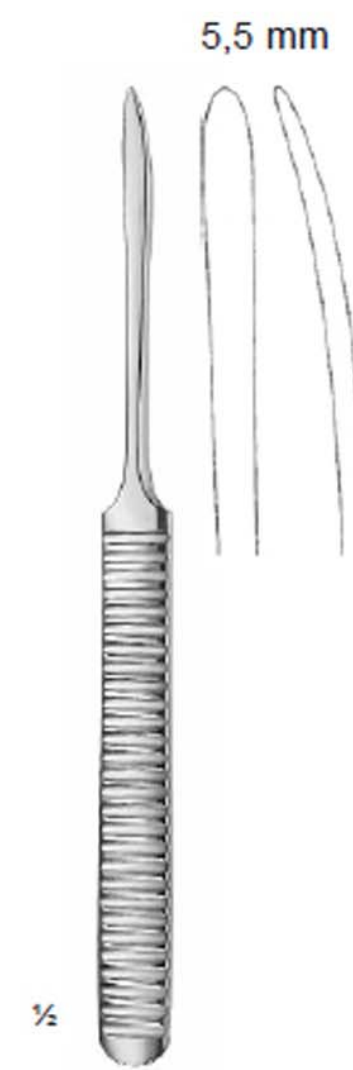

WILLIGER  
82.899.16  
16 cm/6¼"



# MULTICRAFTS Corporation

## SURGICAL INSTRUMENTS

2 mm 2 mm  
2,5 mm 2,7 mm

32.766.12 12,5 cm/5"  
32.766.19 19 cm/7½"

½  
WATSON CHEYNE

6 mm

½  
McDONALD  
32.767.19  
19 cm/7½"

½  
HOWARTH  
32.768.21  
22 cm/8¾"

scharf / stumpf  
sharp / blunt  
aiguë / mousse  
aguda / roma  
acuta / smusso

4 mm

½  
FREER  
46.409.18  
18 cm/7"

4,5 mm

scharf / stumpf  
sharp / blunt  
aiguë / mousse  
aguda / roma  
acuta / smusso

½  
FREER  
46.415.18  
18,5 cm/7¼"

½  
FREER  
46.416.18  
18,5 cm/7¼"

scharf / scharf  
sharp / sharp  
aiguë / aiguë  
aguda / aguda  
acuta / acuta

5 mm

scharf  
sharp  
aiguë  
aguda  
acuta

½  
FREER  
46.417.19  
19 cm/7½"

6 mm

stumpf  
blunt  
mousse  
roma  
smusso

½  
FREER  
46.419.19  
19 cm/7½"

# Neuro Spinal



# MULTICRAFTS Corporation

## Neuro Spinal

### SURGICAL INSTRUMENTS

5 / 5 mm  
 4 / 4 mm  
 4,5 / 4,5 mm  
 4 mm  
 stumpf  
 blunt  
 mousse  
 roma  
 smusso  
 5 mm  
 halbscharf  
 semi-sharp  
 semitranchante  
 semi agudo  
 semiacuto

½  
**COTTLE**  
**46.421.23**  
 23,5 cm/9¼"

½  
**COTTLE**  
**46.426.18**  
 18 cm/7"

½  
**COTTLE**  
**46.426.22**  
 23 cm/9"

½  
**COTTLE**  
**46.432.22**  
 22 cm/8¾"

½  
**SELDIN**  
**82.905.22**  
 19 cm/7½"

½  
**SELDIN**  
**82.905.22**  
 19 cm/7½"

½  
**MOLT**  
**82.910.09**  
 18 cm/7"  
 Nr. 9





# MULTICRAFTS Corporation



Spreizzange für Spekula  
 Spreading forceps for specula  
 Pince écartante pour spéculums  
 Pinza dilatadora para espéculos  
 Pinza divaricatrice per specoli

LANDOLT  
 40.804.21  
 21 cm/8¼"



Lamina-Meißel  
 Lamina Chisel  
 Ciseau burin pour les lames de l'arc vertébral  
 Cincel para lámina  
 Scalpello per lamina

PAPAVERO  
 40.803.22  
 22 cm/8¾"



RAY  
 40.810.04  
 19 cm/7½"

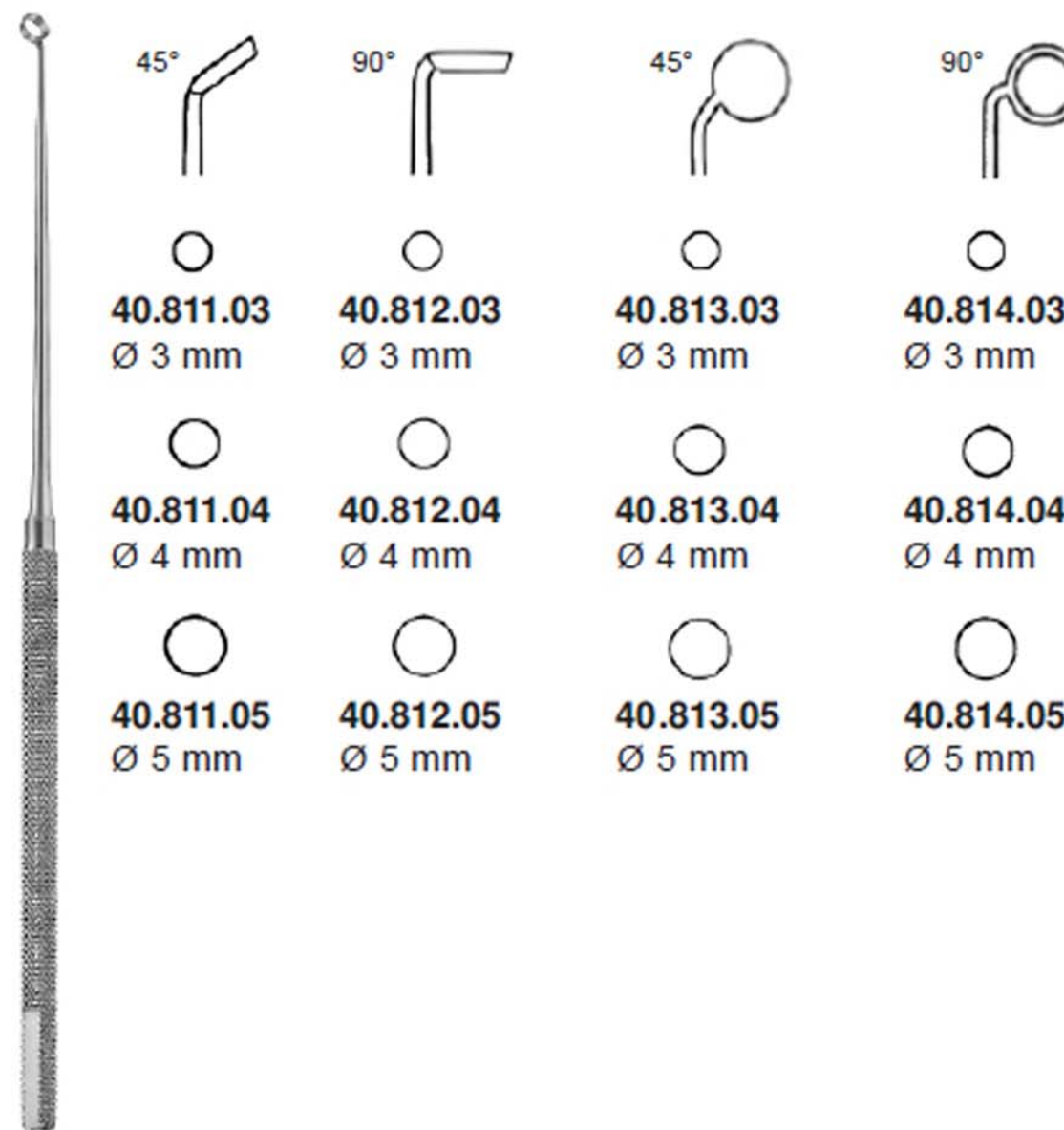

RAY  
 19 cm/7½"

# Neuro Spinal



**Neuro Spinal**



ADSON  
40.210.23  
23 cm/9"



ADSON  
40.211.23  
23 cm/9"

ADSON  
40.213.23  
23 cm/9"



LANDOLT  
40.875.22  
21,5 cm/8½"



HARDY  
40.876.21  
21 cm/8¼"

# NEURO SPINAL SURGERY INSTRUMENTS

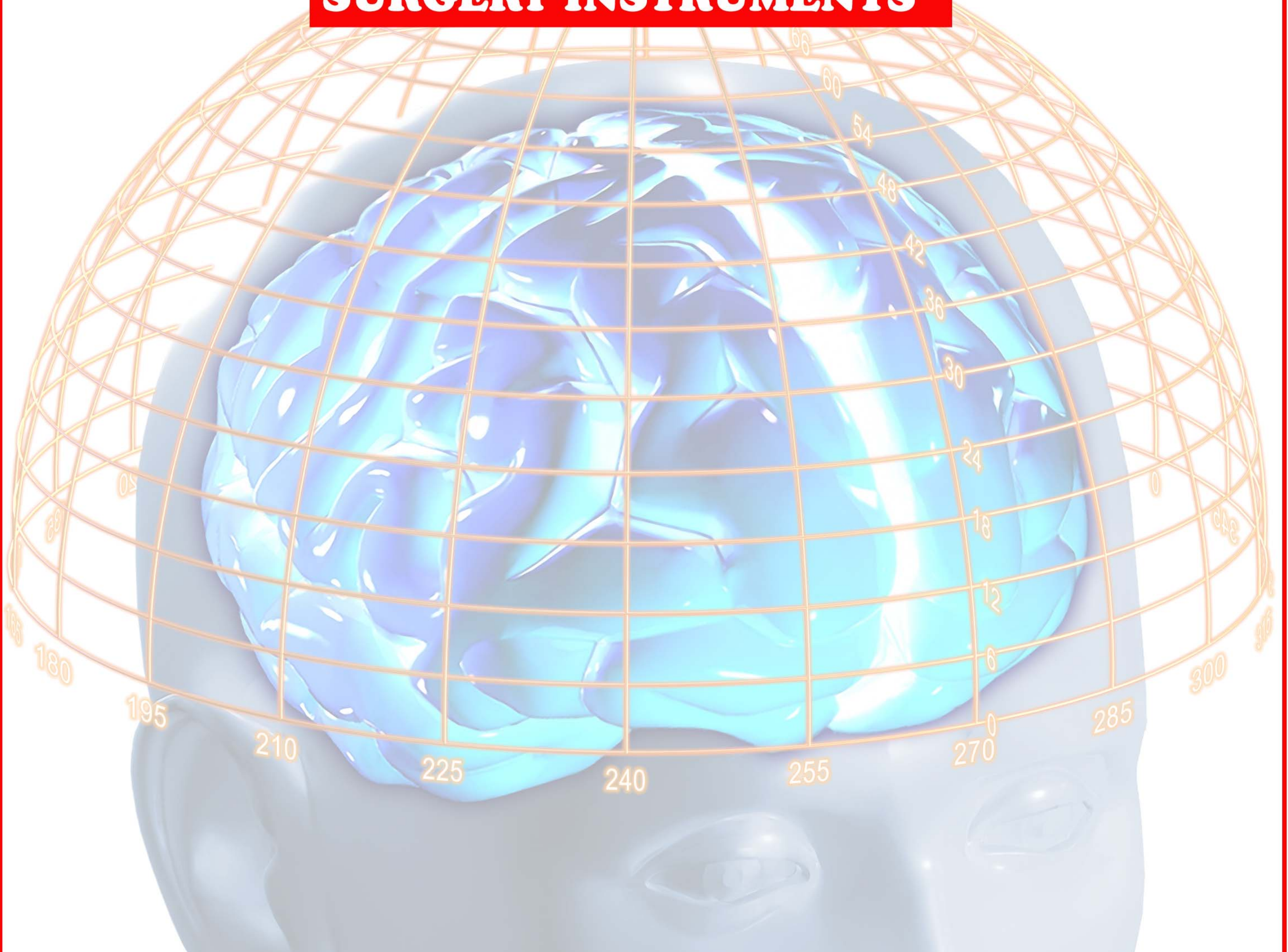

## Multicrafts Corporation

Kotli Behram, Khadim Ali Road  
P.O. Box 949, Sialkot 51310 Pakistan  
Tel: +92 52 426 4892  
Fax: +92 52 426 4692  
@: info@multicrafts.com.pk  
<http://www.multicrafts.com.pk>

**Multicrafts** Corporation