



Multicrafts Corporation

Kotli Behram, Khadim Ali Road
P.O. Box 949, Sialkot 51310 Pakistan
Tel: +92 52 426 4892
Fax: +92 52 426 4692
@: info@multicrafts.com.pk
<http://www.multicrafts.com.pk>



**Orthopedic
Instruments**

Multicrafts *Corporation*





MULTICRAFTS

CORPORATION

P.O. Box 949, Sialkot 51310 Pakistan

Kotli Behram, Khadim Ali Road Tel: +92 426 4892 Fax: +92 52 426 4692

@: info@multicrafts.com.pk <http://www.multicrafts.com.pk>



MULTICRAFTS Corporation

Orthopedic



Drahtzwirbelzange
Twisting Pliers

33.600.20 TC
20,0 cm / 8"



Flachzange
Flat Pliers

33.532.17
17,0 cm / 6½"



Gripzange
Vise Grip

33.533.18
18,0 cm / 7"



Kopfschneider
Wire Cutting Plier

33.540.16
16,0 cm / 6¼"



MULTICRAFTS Corporation



Knochendraht Ringe á 10 m
Wire coils of 10 m

33.530.02 - 33.530.15
weich, soft

33.531.03 - 33.531.10
hart, hard

ø mm	weich soft	hart hard
0,2	33.530.02	
0,3	33.530.03	33.531.03
0,4	33.530.04	33.531.04
0,5	33.530.05	
0,6	33.530.06	33.531.06
0,7	33.530.07	
0,8	33.530.08	33.531.08
0,9	33.530.09	
1,0	33.530.10	33.531.10
1,2	33.530.12	
1,5	33.530.15	



Drahtführungsinstrument
Wire Passer

33.529.45
45 mm



Drahtführungsinstrument
Wire Passer

33.529.70
70 mm



Kneifzange
Wire Cutter

33.545.22 TC
22,0 cm / 8½"
Für Drähte bis ø 2,5 mm
For wires up to ø 2.5 mm

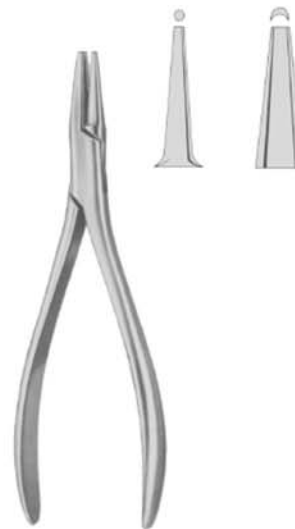

STADLER
Drahtbiegezange
Wire Bending Plier

33.726.16
16,0 cm / 6¼"

Orthopedic



MULTICRAFTS Corporation

Orthopedic



Flachzange
Extraction Plier

33.481.01 TC
18,0 cm / 7"



PALMER
Einschlaginstrument
Impactor

33.481.02
15,0 cm / 6"



PALMER
Nachschlaginstrument
Impactor

33.481.03
17,5 cm / 7"



Steckschlüssel
Wrench

33.602.13



LLOYD
Vorschläger
Impactor

33.602.18



LLOYD
Vorschläger, Nagelzieher
Impactor-Extractor

33.602.20



RITCHEY
Vorbohrer
Nail Starter

33.302.22



MULTICRAFTS Corporation



SVEN JOHANSSON
Vorschläger
Impactor
33.602.30



SVEN JOHANSSON
Nachschläger
Impactor
33.602.34

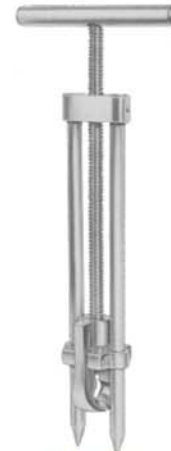

Nagelzieher
Nail Extractor
33.602.50



Messhülse
Measuring Gauge
36.918.00

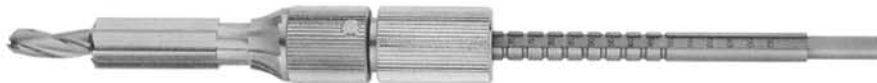

Dreifach Fräser
Triple Reamer
36.920.00



Gewindeschneider
Tap
36.922.00



Gewebeschutzhülse, kurz, zum Gewindeschneiden
Guide Sleeve, short for tapping
36.924.01



Gewebeschutzhülse, lang, zum Verschrauben
Guide Sleeve, long for screwing
36.924.02

Orthopedic



MULTICRAFTS Corporation

Orthopedic



Führungsschaft
Guide shaft

36.926.00



Kuplungsschraube
Coupling Screw

36.926.02



Kuplungsschraube
Coupling Screw

36.928.00



Neue Kuplungsschraube
New Coupling Screw

36.928.01



Schlüssel
Wrench

36.930.00



Neuer Schlüssel
New Wrench

36.930.01



MULTICRAFTS Corporation



Einschläger
Impactor

36.932.00



Neuer Einschläger
New Impactor

36.932.01



Griff
Handle

36.934.00

Orthopedic



Biegehebel
Bending Iron
33.558.00



33.562.24
für Marknägel ø 2,4 mm
for Intramedullary Pins ø 2,4 mm



33.562.32
für Marknägel ø 3,2 mm
for Intramedullary Pins ø 3,2 mm

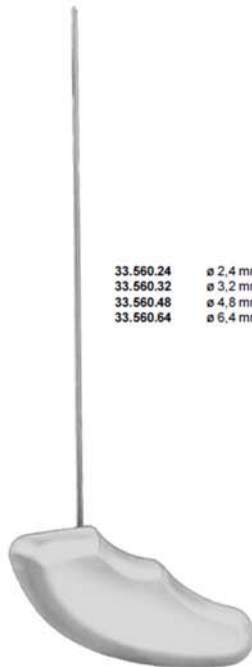

33.560.24 ø 2,4 mm
33.560.32 ø 3,2 mm
33.560.48 ø 4,8 mm
33.560.64 ø 6,4 mm

Vorböhrer
Rush Awl and Reamer
33.560.24 - 33.560.64



33.809.01 klein / small
33.809.02 mittel / medium
33.809.03 groß / large

Drahtführungsinstrument
Wire Guide
33.809.01 - 33.809.03



33.562.48
für Marknägel
ø 4,8 mm
for Intramedullary
Pins ø 4,8 mm



33.562.64
für Marknägel
ø 6,4 mm
for Intramedullary
Pins ø 6,4 mm



MULTICRAFTS Corporation



KÜNTSCHER
Vorbohrer / Diamond Point Awl
33.571.26



KÜNTSCHER
Aufreiber / Reamer
33.573.35



Führungsspieß / GuidePin
33.581.35 - 33.585.60

cm	inch	ø 2,5 mm	ø 3,0 mm	ø 3,5 mm	ø 4,0 mm	ø 5,0 mm
35	13 3/4	33.581.35	33.582.35	33.583.35	33.584.35	33.585.35
46	18	33.581.46	33.582.46	33.583.46	33.584.46	33.585.46
60	23 1/2			33.583.60	33.584.60	33.585.60



KÜNTSCHER, Extraktor / Nail Extractor
33.590.00



33.590.11



33.590.01



33.590.02



33.590.03



33.590.04



33.590.10

Orthopedic



Orthopedic

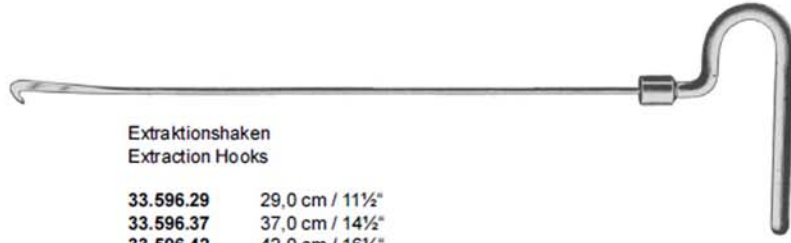

Extraktionsshaken
Extraction Hooks

- | | |
|-----------|----------------|
| 33.596.29 | 29,0 cm / 11½" |
| 33.596.37 | 37,0 cm / 14½" |
| 33.596.42 | 42,0 cm / 16½" |
| 33.596.49 | 49,0 cm / 19¼" |



Hautschutzplatte
Skin Protector

36.049.02



KÜNTSCHER
Vorschläger
Nail Driver

33.586.21



KÜNTSCHER
Vorschläger geschlitzt
Slotted Nail Driver

33.587.21



KÜNTSCHER
Einschlaginstrument
Final Impactor

33.588.21



Schlitzhammer
Slotted Hammer

33.598.30



MULTICRAFTS Corporation

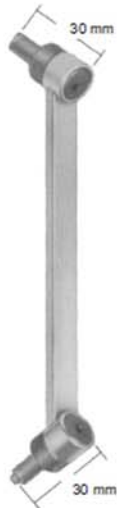

Bohrbüchse
Drill Guide

33.125.27

für Bohrer ø 2,0 mm · for Drill Bit ø 2,0 mm
für Kortkasschrauben ø 2,7 mm · for Cortical screws ø 2,7 mm



Schränkeisen
Bending Iron

33.642.00
13,0 cm / 5"



Biegezange für kleine Platten
Bending Plier for small plates

33.650.14
13,5 cm / 5½"



Raspatorium
Periosteal Elevator

32.783.03
18,0 cm · 3 mm



HOHMANN
Knochenheber
Retractor

32.811.06
6 mm



HOHMANN
Knochenheber
Retractor

32.811.08
8 mm



Knochenheber
Retractor

32.539.16
16 mm

Orthopedic



Haltezangen für kleine Platten Holding Forceps for small plates



32.398.99
12,0 cm / 4¾"



32.306.12
12,0 cm / 4¾"

Repositionszangen Reduction Forceps



32.308.14
13,5 cm / 5¼"



32.409.13
13,5 cm / 5¼"



MULTICRAFTS Corporation

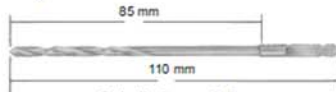

Spiralbohrer \varnothing 3,5 mm
Drill Bits \varnothing 3.5 mm

33.356.35

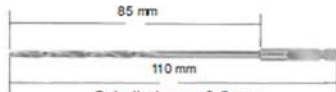

Spiralbohrer \varnothing 2,5 mm
Drill Bits \varnothing 2.5 mm

33.356.25

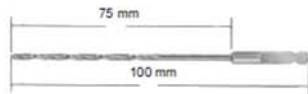

Spiralbohrer \varnothing 2,0 mm
Drill Bits \varnothing 2.0 mm

33.356.20



Handstück
Tap Handle

33.864.00
11,0 cm / 4 1/2"



für kleine Schrauben \varnothing 2,7 mm / \varnothing 3,0 mm / \varnothing 4,0 mm
for small screws \varnothing 2.7 mm / \varnothing 3.0 mm / \varnothing 4.0 mm

Kopfraumfräser
Countersink

33.822.20
7,0 cm / 2 3/4" \varnothing 2,0 mm



Seigung 1,25 mm - thread pitch 1,25 mm
für Kortikalschrauben - for Cortical screws

Gewindeschneider
Tap

33.830.35
11,0 cm / 4 1/2" \varnothing 3,5 mm



Seigung 1,75 mm - thread pitch 1,75 mm
für Spongialschrauben - for Cancellous screws

Gewindeschneider
Tap

33.840.35
11,0 cm / 4 1/2" \varnothing 3,5 mm



für Bohrer \varnothing 2,0 mm
for Drill Bits \varnothing 2.0 mm

Ziel- und Plattenbohrhülse
Drill Guide and Sleeve

33.872.20



Steckbohrbüchse
Insert Drill Sleeve

33.312.44

für Bohrer \varnothing 2,5 mm / \varnothing 2,7 mm
for Drill Bits \varnothing 2.5 mm / \varnothing 2.7 mm

für Schrauben \varnothing 2,7 mm / 3,5 mm
for screws \varnothing 2.7 mm / 3.5 mm



für Bohrer \varnothing 2,5 mm
for Drill Bits \varnothing 2.5 mm

für Kortikalschrauben \varnothing 3,5 mm
for Cortical Screws \varnothing 3.5 mm

für Gewindeschneider \varnothing 3,5 mm
for Tap \varnothing 3.5 mm

Gewebeschutzhülse und Bohrbüchse
Tap Sleeve and Drill Sleeve

33.887.35



Schraubenzieher
Hexagonal Screwdriver

33.630.25
19,5 cm / 7 3/4"



Schraubenzieher-Einsatz
Hexagonal Screwdriver Shaft

33.629.25
10,0 cm / 4"

Orthopedic



Orthopedic



Schraubenmeßgerät
Screw Depth Gauge

33.828.00
16,0 cm / 6¼"



Scharfer Haken
Sharp Hook

33.842.39
16,0 cm / 6¼"



Halteklammer
Plate Holding Clip

33.842.35



Schraubenpinzette
Screw Forceps

33.839.09
8,0 cm / 3½"



Bohrbüchse
Drill Guide

34.125.35

für Bohrer ø 2,5 mm - for Drill Bit ø 2,5 mm
für Kortkantschrauben ø 3,5 mm - for Cortical screws ø 3,5 mm



Schränkeisen für kleine Platten
Bending Iron for small plates

33.643.01
14,5 cm / 5½"



33.643.02
14,5 cm / 5½"



Biegeschablonen
Bending Templates

33.676.06
5-Loch / 5 holes



Biegeschablonen
Bending Templates

33.676.08
7-Loch / 7 holes



MULTICRAFTS Corporation



Raspatorium klein
Periosteal Elevator
32.774.06
18,0 cm / 6 mm



HOHMANN
Knochenhebel
Retractor
32.811.06
6 mm



HOHMANN
Knochenhebel
Retractor
32.811.08
8 mm



HOHMANN
Knochenhebel
Retractor
32.811.15
15 mm



Repositionszange
Bone Reduction Forceps
32.308.14
13,5 cm / 5 1/4"



Repositionszange
Bone Reduction Forceps
32.409.13
13,5 cm / 5 1/4"



Biegezange für kleine Platten
Bending Plier for small plates
32.650.14
13,5 cm / 5 1/2"



Knochenhaltezange
Bone Holding Forceps
32.391.15
15,0 cm / 6"

Orthopedic



MULTICRAFTS Corporation

Orthopedic



Schraubenzieher
Screw driver

33.628.35
25,0 cm / 10"

3,5 mm

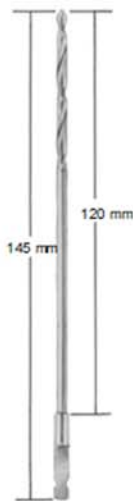

Bohrer
Drill Bits

33.356.32
ø 3,2 mm

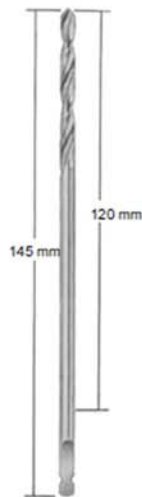

Bohrer
Drill Bits

33.356.45
ø 4,5 mm

ø 3,2 mm



für Malleolarschrauben
for Malleolar screws

Kopfraumfräser
Countersink

33.824.32
12,0 cm / 4 7/8"

ø 4,5 mm



Kopfraumfräser
Countersink

33.826.45
18,0 cm / 7"



Griffstück für
Gewindeschneider
Tap Handle

33.866.00
8,5 cm / 3 1/2"



MULTICRAFTS Corporation

ø 4,5 mm



Gewindeschneider
Tap

33.830.45
13,0 cm / 5"

ø 4,5 mm



Gewindeschneider
Tap

33.832.45
13,0 cm / 5"

ø 6,5 mm



Gewindeschneider
Tap

33.840.65
20,0 cm / 5"



Gewebeschtzöhülse
Drill Sleeve

33.885.35
11,0 cm / 4 1/2"

für Bohrer ø 3,2 mm
for Drill Bits ø 3,2 mm
für Schrauben ø 4,5 mm
for screws ø 4,5 mm



Steck-Bohrbüchse
Insert Drill Sleeve

33.874.45
5,0 cm / 2"

ø 4,5 mm



Gewebeschtzöhülse
Drill Sleeve

33.889.45



Zielgerät
Pointed Drill Guide

33.881.45
15,0 cm / 6"

3,5 mm



Schraubendrehereinsatz
Hexagonal Screwdriver

33.629.35
11,5 cm / 4 1/2"



Schraubenmeßgerät
Screw Depth Gauge

33.829.01
22,0 cm / 8 3/4"



Scharfer Haken
Sharp Hook

33.842.39
16,0 cm / 6 1/4"

Orthopedic



Orthopedic



40 mm
für Bohrer ø 3,2 mm
for Drill Bit ø 3,2 mm

Bohrbüchse
Drill Sleeve

34.105.40
11,5 cm / 4½"



für Bohrer ø 3,2 mm
for Drill Bit ø 3,2 mm

Drill Sleeve for
Tension Device
Bohrlehre für
Plattenspanner

34.102.32
5,0 cm / 2"



Plattenspanner
Tension Device

34.110.08
6,0 cm / 2½"



Plattenspanner
Tension Device Articulated

34.111.16
9,0 cm / 3½"



Kardanschlüssel
Socket Wrench

34.115.11
18,5 cm / 7½"



Gabelschlüssel
Wrench

34.116.11
15,0 cm / 6"



40 mm

Bohrbüchse
Drill Guide

34.127.45
16,5 cm / 6½"

für Bohrer ø 3,2 mm - for Drill Bit ø 3,2 mm
für Kortikalschrauben ø 4,5 mm - for Cortical screws ø 4,5 mm



Biegeschablone 5-Loch
Bending Templates 5 Holes

33.374.09



Biegeschablone 7-Loch
Bending Templates 7 Holes

33.674.12



Biegeschablone 9-Loch
Bending Templates 9 Holes

33.674.15



MULTICRAFTS Corporation



Schränkeisen für Standard Platten
Bending Iron for Standard Plates

33.645.00

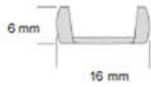

Klingenmeißel
Seating Chisel

34.332.12
32,0 cm / 12½"

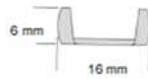

Klingenmeißel
Seating Chisel

34.332.13
28,5 cm / 11½"



Ein- und Ausschlaginstrument
Inserter / Extractor

34.332.15
27,0 cm / 10½"



Schlitzhammer
Slotted Hammer

34.332.20
27,0 cm / 10½"



Nachschlaginstrument
Impactor

34.332.21
20,5 cm / 8½"

Orthopedic



Orthopedic



Drahtwirbelzange
Twisting Plier

33.500.20 TC
20,0 cm / 8"



Flachzange
Flat Pliers

33.532.17
17,0 cm / 6½"



Grip Zange
Vise Grip

33.533.18
18,0 cm / 7"



Kopfschneider
Wire Cutting Plier

33.540.16
16,0 cm / 6¼"



Kneifzange für Drähte bis ø 2,5 mm
Wire Cutter for wire up to ø 2.5 mm

33.545.22 TC
22,0 cm / 8½"



MULTICRAFTS Corporation



Drahteführungsinstrument
Wire Passer

33.529.45
45 mm



Drahteführungsinstrument
Wire Passer

33.529.70
70 mm



Draht, weich \varnothing 1,0 mm
Draht, weich \varnothing 1,5 mm
Wire soft \varnothing 1.0 mm
Wire soft \varnothing 1.5 mm

33.530.10 - 33.530.15

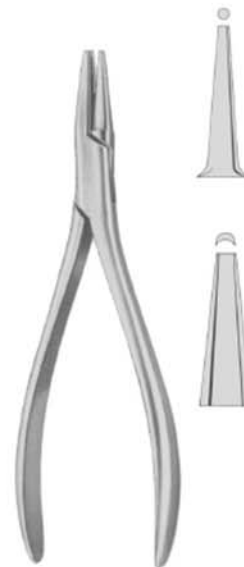

STADLER
Drahtbiegezange
Wire Bending Forceps

87.626.16
16,0 cm / 6 1/4"

Orthopedic



MULTICRAFTS Corporation

Orthopedic



Spiralbohrer
Drill Bits



Spiralbohrer
Drill Bits



Flachbohrer
Flat Drill



Kugelfräser
Spherical Bur



Konischer Fräser
Conical Bur



Spiralbohrer
Drill Bit

ø mm					
1,0		33.352.10			33.354.10
1,2		33.352.12			
1,5		33.352.15			33.354.15
1,8		33.352.18	33.358.18		
2,0	33.350.20	33.352.20	33.358.20		33.354.20
2,2		33.352.22	33.358.22		
2,5	33.350.25	33.352.25	33.358.25		33.354.25
2,8		33.352.28			33.354.28
3,0	33.350.30	33.352.30	33.358.30	33.359.30	33.359.31
3,2	33.350.32	33.352.32			33.354.32
3,5	33.350.35	33.352.35	33.358.35		33.354.35
4,0	33.350.40	33.352.40	33.358.40	33.359.40	33.354.40
5,0	33.350.50	33.352.50	33.358.50		33.359.50
6,0	33.350.60				33.354.60
7,0	33.350.70				



MULTICRAFTS Corporation



Kugelfräser
Spherical Bur

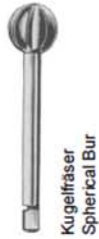

Kugelfräser
Spherical Bur

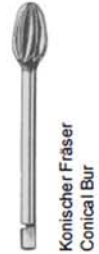

Konischer Fräser
Conical Bur



Konischer Fräser
Conical Bur



Zylindrischer Fräser
Cylindric Bur

ø mm	DOYEN	DOYEN	DOYEN		DOYEN
4,0	33.362.04	33.364.04			
6,0	33.362.06	33.364.06			
7,0					
8,0	33.362.08	33.364.08		33.368.08	
10,0	33.362.10	33.364.10		33.368.10	
12,0	33.362.12	33.364.12	33.366.12		33.370.12
13,0					
14,0	33.362.14	33.364.14			
15,0					33.370.15
16,0	33.362.16	33.364.16			
25,0					

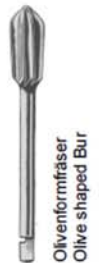

Olivenförmiger Fräser
Olive shaped Bur



Spitzenfräser
Sharp pointed Bur



Olivenförmiger Fräser
Olive shaped Bur



Flachfräser
Flat Bur



Trephine mit Dorn
Trephine

ø mm	ALBEE	ALBEE	BOCHARDT		TOTI
4,0					
6,0					
7,0		33.374.07			
8,0	33.372.08				33.378.08
10,0	33.372.10				
12,0	33.372.12				
13,0			33.376.13		
14,0					
15,0					
16,0					
25,0				33.377.25	

Orthopedic



MULTICRAFTS Corporation

Orthopedic



Raspatorium
Periosteal Elevator

32.779.06
18,0 cm / 7"



Raspatorium
Periosteal Elevator

32.783.03
18,0 cm / 7"



33.628.25
25,0 cm / 10"



33.628.35
25,0 cm / 10"



33.672.17
17,0 cm / 6 1/2"



LANE
33.620.25
25,0 cm / 10"





MULTICRAFTS Corporation



33.632.25
25,0 cm / 10"

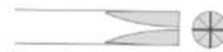

PHILIPS
33.672.25
25,0 cm / 10"

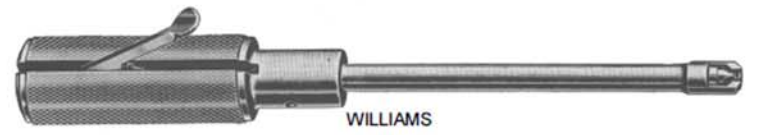

WILLIAMS
33.624.24
24,0 cm / 9½"

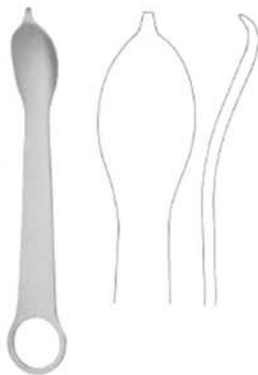

32.539.16
16 mm

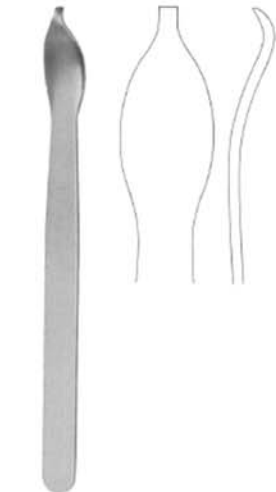

32.539.15
15 mm



32.811.06
16,0 cm



32.811.08
16,0 cm

MINI-HOHMANN
32.811.06 - 32.811.08

Orthopedic



MULTICRAFTS Corporation



Behälter mit Instrumentarium
Case with Instruments

33.482.00

Behälter ohne Instrumentarium
Case without Instruments

33.482.01

Einsätze
Screw Driver Shafts



Schraubenziehergriff
Screwdriver Handle

33.482.02
14,5 cm / 5½"



33.482.03
14,0 cm / 5½"



33.482.06
14,0 cm / 5½"



33.482.09
14,0 cm / 5½"



33.482.10
14,0 cm / 5½"



JACOBS
Universalbohrfutter
Universal Chuck

33.482.13
7,5 mm / 3"



33.482.18
14,0 cm / 5½"



33.482.19
14,0 cm / 5½"

Orthopedic



MULTICRAFTS Corporation

Artikel-Nr.
Cat. No.

36.926.12 Plattenschneidezange
12 cm, mit Hartmetall
Plate cutting pliers
12 cm, with Tungsten Carbide inserts



Artikel-Nr.
Cat. No.

36.926.13 Flachzange, 13,5 cm
Flat pliers, 13,5 cm



Artikel-Nr.
Cat. No.

36.820.15 Plattenbiegezange ADERER, 15 cm
Plate bending pliers ADERER, 15 cm



Artikel-Nr.
Cat. No.

36.972.15 Platten/Schrauben-Haltepinzette,
TITAN, 15 cm
Plates and screws holding forceps
TITANIUM, 15 cm



Orthopedic



MULTICRAFTS Corporation

Orthopedic

Artikel-Nr.
Cat. No.

33.545.18 Plattenschneidezange
18 cm, mit Hartmetall
Plate cutting pliers,
18 cm, with Tungsten Carbide inserts



Artikel-Nr.
Cat. No.

36.820.15 Plattenbiegezange ADERER, 15 cm
Plate bending pliers ADERER, 15 cm



Artikel-Nr.
Cat. No.

36.821.15 Plattenbiegezange
15 cm, mit Stift
Plate bending pliers
15 cm, with pin





MULTICRAFTS Corporation

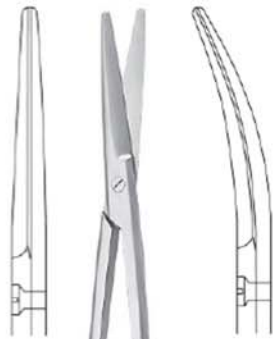

TC-Schneiden
TC Cutting Edges

MAYO

14,5 cm/5¾"	08.164.14	08.165.14
17 cm/6¾"	08.164.17	08.165.17
23 cm/9"	08.164.23	08.165.23

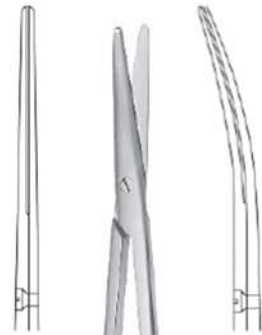

TC-Schneiden
TC Cutting Edges

MAYO-STILLE

15 cm/6"	08.174.15	08.175.15
17 cm/6¾"	08.174.17	08.175.17

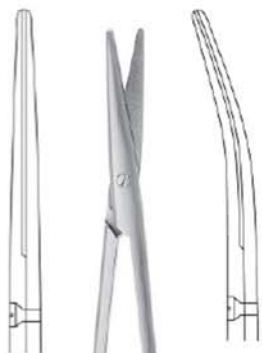

TC-Schneiden
TC Cutting Edges

LEXER

16 cm/6¼"	08.194.16	08.195.16
-----------	-----------	-----------

Orthopedic



MULTICRAFTS Corporation

Orthopedic



TC-Schneiden
TC Cutting Edges

METZENBAUM

15 cm/6"	08.284.15	08.285.15
18 cm/7"	08.284.18	08.285.18
20 cm/8"	08.284.20	08.285.20
23 cm/9"	08.284.23	08.285.23



TC-Schneiden
TC Cutting Edges

METZENBAUM FINO

15 cm/6"	08.286.15	08.287.15
18 cm/7"	08.286.18	08.287.18
20 cm/8"	08.286.20	08.287.20
23 cm/9"	08.286.23	08.287.23



08.297.14
14,5 cm/5 3/4"

08.297.18
18 cm/7"

TC-Schneiden
TC Cutting Edges

METZENBAUM FINO



TC-Schneiden
TC Cutting Edges

KILNER

12 cm/4 3/4"	08.314.12
15 cm/6"	08.314.15



MULTICRAFTS Corporation



eine Schneide gezahnt
one toothed cutting edge

TC-Schneiden
TC Cutting Edges

LOCKLIN
08.316.16
16 cm/6 1/4"



TC-Schneiden
TC Cutting Edges

IRIS
08.344.11
11,5 cm/4 1/2"



IRIS
08.345.11
11,5 cm/4 1/2"



Eine Schneide gezahnt
One toothed cutting edge

TC-Schneiden
TC Cutting Edges

GOLDMAN FOX
08.823.13
13 cm/5"



1:2
0,5
normalprofil
regular profile

Mit TC-Einsätzen
TC Lined

ADSON
12 cm/4 3/4" **10.184.12**
15 cm/6" **10.184.15**



1:2
0,4
Miniprofil
mini profile

Mit TC-Einsätzen
TC Lined

ADSON micro
12 cm/4 3/4" **10.173.12**
15 cm/6" **10.173.15**



1:2
0,4
Miniprofil
mini profile

Mit TC-Einsätzen
TC Lined

GILLIES
10.272.16
15,5 cm/6"

Orthopedic



MULTICRAFTS Corporation

Orthopedic

ATRAUMA



DE BAKEY



Mit TC-Einsätzen
TC Lined

1,5 mm

2,0 mm

2,7 mm

3,5 mm

6 x 12

6 x 12

6 x 12

6 x 12



15 cm/6"	11.404.15	11.412.15	11.414.15	11.416.15
19,5 cm/7¾"	11.404.19	11.412.19	11.414.19	11.416.19
24 cm/9½"	11.404.24	11.412.24	11.414.24	11.416.24

1,5 mm

2,0 mm

2,7 mm

3,5 mm

2 x 4

2 x 4

2 x 4

2 x 4



15 cm/6"	11.402.15	11.422.15	11.424.15	11.426.15
19,5 cm/7¾"	11.402.20	11.422.19	11.424.19	11.426.19
24 cm/9½"	11.402.24	11.422.24	11.424.24	11.426.24

DE BAKEY



MULTICRAFTS Corporation

Mit TC-Einsätzen
TC Lined



24.134.13

glattes Maul
smooth jaw

24.144.13

0,4
Miniprofil
mini profile

HALSEY
13 cm/5 1/4"



mit aufgebogenem Daumenring
with offset ring

24.147.13

0,4
Miniprofil
mini profile

NEIVERT
13 cm/5 1/4"

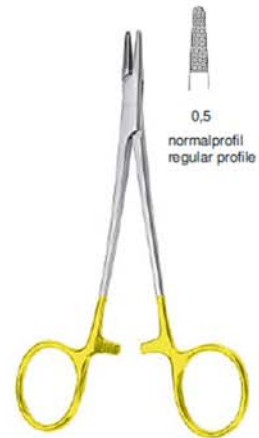

0,5
normalprofil
regular profile

BAUMGARTNER
12,5 cm/5" 24.154.12
14 cm/5 1/2" 24.154.14



0,5
normalprofil
regular profile

NEW ORLEANS
24.144.18
18 cm/7"



0,4
Miniprofil
mini profile

CRILE WOOD

24.164.15
15 cm/6"

24.164.18
18 cm/7"

24.164.20
20 cm/7 3/4"

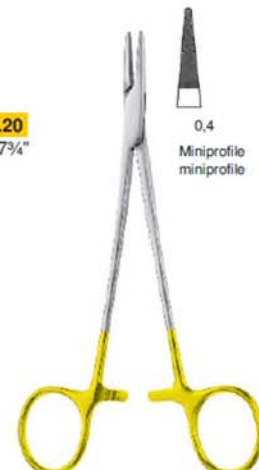

0,4
Miniprofil
mini profile

BABY CRILE WOOD
24.168.15
15 cm/6"

Orthopedic



MULTICRAFTS Corporation

Orthopedic



- | | | | |
|---|---|---|---|
|  |  |  |  |
| 24.184.14
14 cm/5½" | 24.184.16
16 cm/6¼" | 24.184.18
18 cm/7" | 24.184.20
20 cm/8" |
|  |  |  | |
| 24.184.24
24 cm/9½" | 24.184.26
26 cm/10¼" | 24.184.30
30 cm/12" | 0,5
normalprofil
regular profile |
|  |  | glattes Maul
smooth jaw | |
| 24.186.16
16 cm/6¼" | 24.186.18
18 cm/7" | | |



- | | | | |
|---|---|---|---|
|  |  |  |  |
| 24.216.16
16 cm/6¼" | 24.216.18
18 cm/7" | 24.216.21
21 cm/8¼" | 24.216.23
23 cm/9" |

0,2
mikroprofil
micro profile

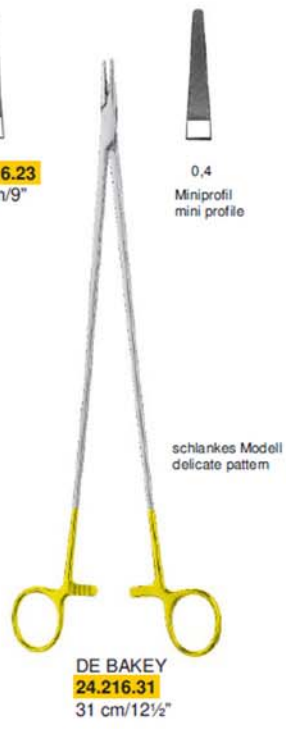

0,4
Miniprofil
mini profile



MULTICRAFTS Corporation



CASTROVIEJO-JACOBSON

glattes Maul smooth jaw	glattes Maul smooth jaw	0,3 Mikroprofil micro profile	0,3 Mikroprofil micro profile

14,5 cm/5 3/4"	24.674.14	24.675.14	24.678.14	24.679.14
18 cm/7"	24.674.18	24.675.18	24.678.18	24.679.18
21 cm/8 1/4"	24.674.21	24.675.21	24.678.21	24.679.21
23 cm/9"	24.674.23	24.675.23	24.678.23	24.679.23

mit sperre
with catch

glattes Maul smooth jaw	glattes Maul smooth jaw	0,3 Mikroprofil micro profile	0,3 Mikroprofil micro profile

14,5 cm/5 3/4"	24.694.14	24.695.14	24.698.14	24.699.14
18 cm/7"	24.694.18	24.695.18	24.698.18	24.699.18
21 cm/8 1/4"	24.694.21	24.695.21	24.698.21	24.699.21
23 cm/9"	24.694.23	24.695.23	24.698.23	24.699.23

ohne sperre
without catch

Orthopedic



Orthopedic



BRUENINGS
48.107.19
19 cm/7½"
19 / 15 mm



DOYEN

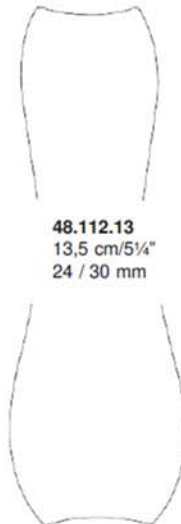

48.112.13
13,5 cm/5¼"
24 / 30 mm

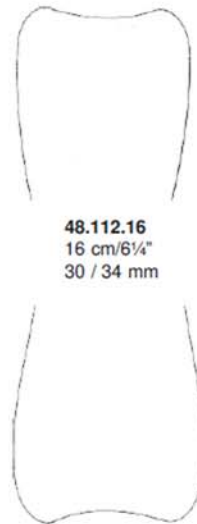

48.112.16
16 cm/6¼"
30 / 34 mm



HARTMANN
48.111.15
15 cm/6"



72 x 23 mm



TOBOLD
48.119.14
14,5 cm/5¾"



85 x 24 mm



TOBOLD
48.119.15
15 cm/6"



88 x 25 mm



MULTICRAFTS Corporation



WIEDER

48.115.01
14 cm/5½"
36 mm

48.115.02
15 cm/6"
43 mm

Lippen- und Wangenhalter
Wire lip retractor



STERNBERG
48.229.14
14 cm/5½"

SIMPLEX
48.230.11
11 cm/4¼"

Zungenzangen
Tongue Holding Forceps

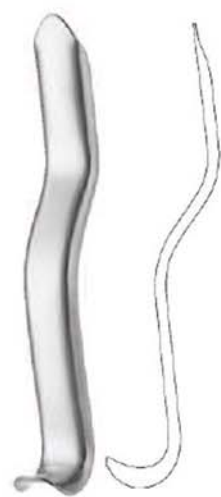

CAWOOD-MINNESOTA
48.233.15
15 cm/6"
20 mm



COLLIN
48.250.16
16 cm/6½"



YOUNG
48.255.16
16 cm/6½"

48.255.99
Gummipolster (Paar)
Rubber inserts (Pair)

Orthopedic



MULTICRAFTS Corporation

Orthopedic



DENHARDT
48.267.12
12 cm/5"



ROSER-KOENIG
16 cm/6¼" 48.270.16
19 cm/7½" 48.270.19



HEISTER
48.272.13
13 cm/5¼"



MIDDELDORPF

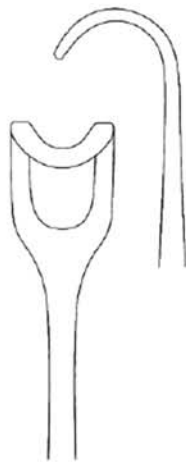

18.344.14
21,5 cm/8½"
14 x 17 mm

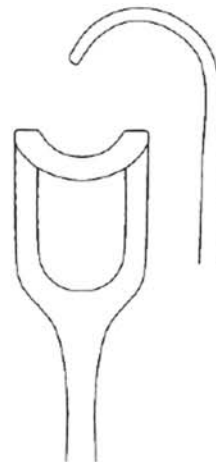

18.344.20
22 cm/8¾"
20 x 22 mm

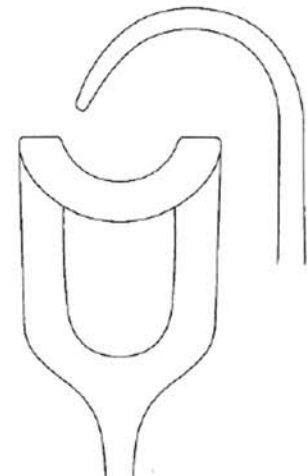

18.344.26
23,5 cm/9¼"
26 x 30 mm



MULTICRAFTS Corporation



BÜCHS
18.346.20
 20,5 cm/8"
 38 x 18 mm



GREEN
18.348.22
 22,5 cm/8¾"
 22 x 22 mm



KIRSCH
 20 cm/8"

Mucoperiosthaken
 Diagonal Cheek Retractors for lateral region

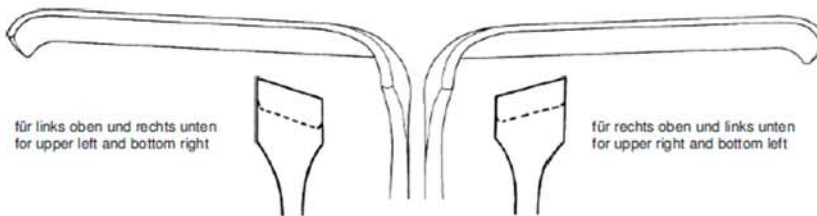

für links oben und rechts unten
 for upper left and bottom right

48.588.20
 60 x 10 mm

für rechts oben und links unten
 for upper right and bottom left

48.589.20
 60 x 10 mm

Orthopedic



MULTICRAFTS Corporation

Orthopedic



WARD
48.590.15
15,5 cm/6"



BOWDLER-HENRY
48.590.70
16 cm/6¼"



KAY (AUSTIN)
48.590.73

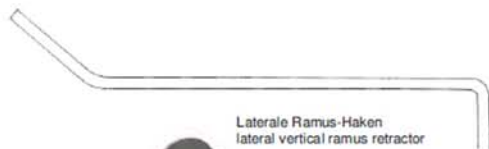

Lateral Ramus-Haken
lateral vertical ramus retractor



MUNRO
16 cm/6¼"

48.591.20 20 x 80 mm
48.591.25 25 x 80 mm
48.591.30 30 x 80 mm
48.591.35 35 x 80 mm



MULTICRAFTS Corporation

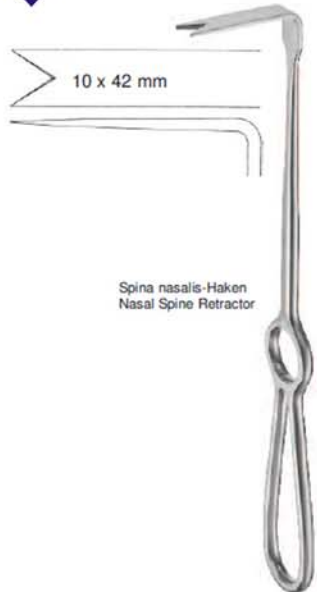

Spina nasalis-Haken
Nasal Spine Retractor

OBWEGESER
48.595.22
22 cm/8 3/4"

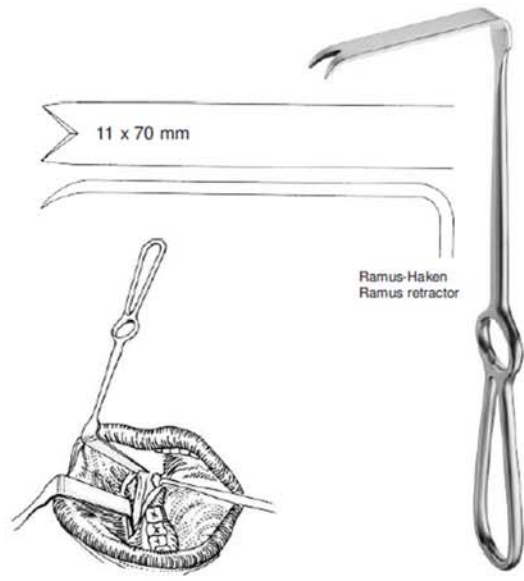

Ramus-Haken
Ramus retractor

OBWEGESER
48.597.22
22 cm/8 3/4"

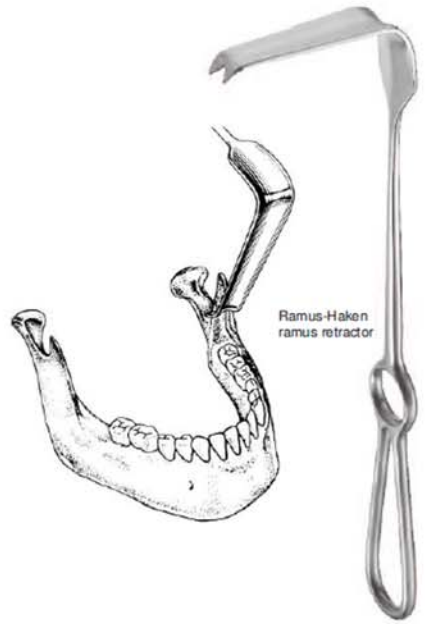

Ramus-Haken
ramus retractor

OBWEGESER
24,5 cm/9 3/4"

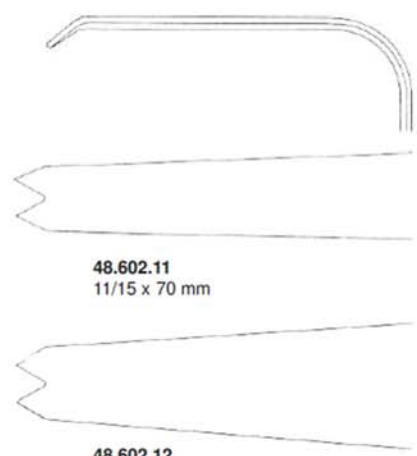

48.602.11
11/15 x 70 mm

48.602.12
12/22 x 70 mm

Orthopedic



Orthopedic



Weichteilhaken
Soft Tissue Retractor

OBWEGESER
21,5 cm/8½"

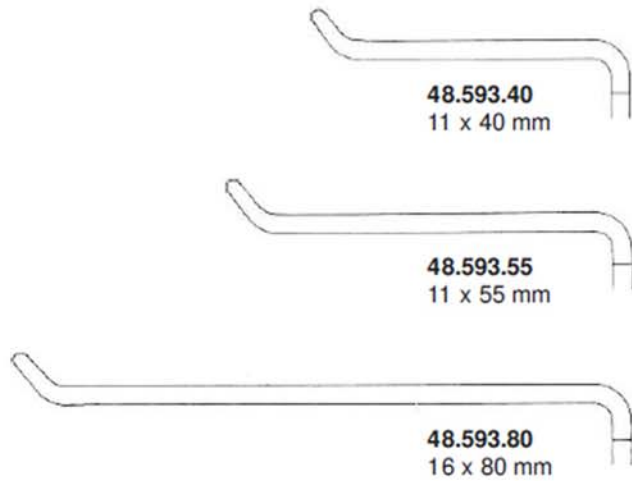

48.593.40
11 x 40 mm

48.593.55
11 x 55 mm

48.593.80
16 x 80 mm



MULTICRAFTS Corporation

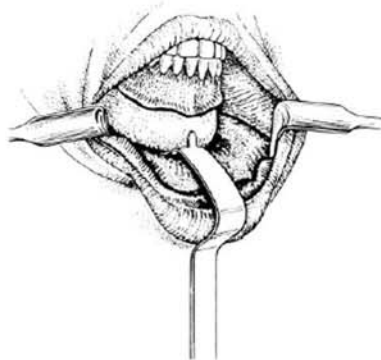

Kinnhalter
Chin Retractor

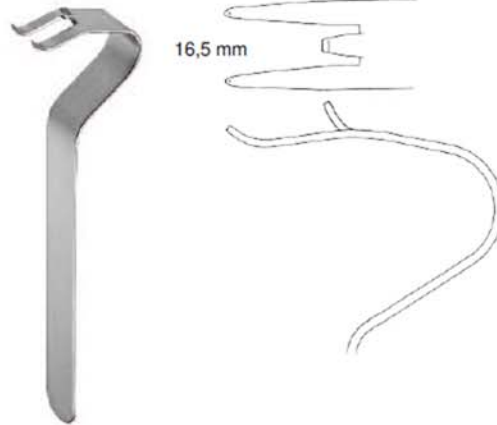

OBWEGESER
48.601.16
16 cm/6¼"

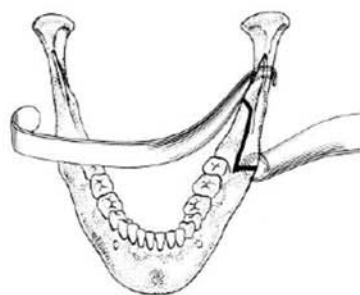

Progenierinnen
Channel Retractors



OBWEGESER
16,5 cm/6½"

Orthopedic



MULTICRAFTS Corporation

Orthopedic

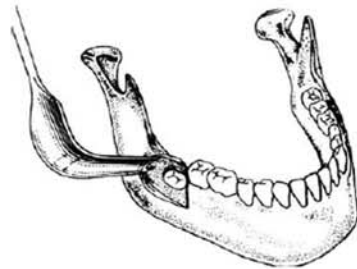

Weisheitszahn-Haken
Third Molar Retractor

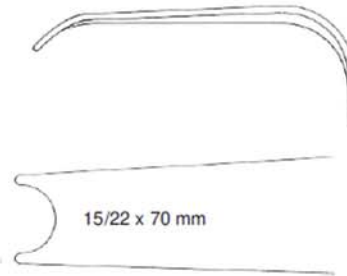

OBWEGESER
48.603.00
24 cm/9½"

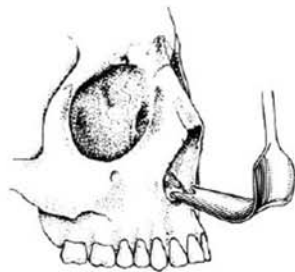

Spina nasalis-Haken
Nasal Spine Retractor

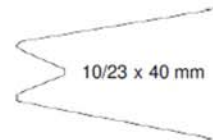

OBWEGESER
48.604.24
24,5 cm/9½"



MULTICRAFTS Corporation

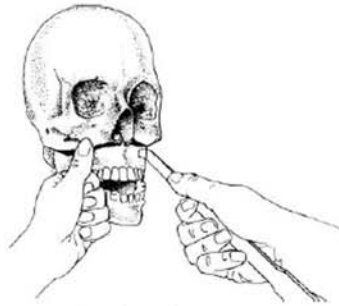

Maxilla-Mobilisator
Maxilla Mobilizer



12 mm

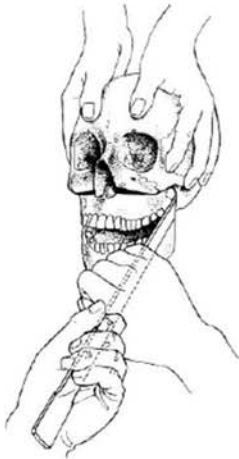

OBWEGESER
48.605.23
23 cm/9"

48.507.01
9 mm
rechts
right

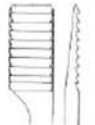

Oberkiefer-Mobilisierhaken
Retromaxillary levers

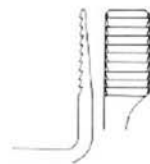

48.507.02
9 mm
links
left

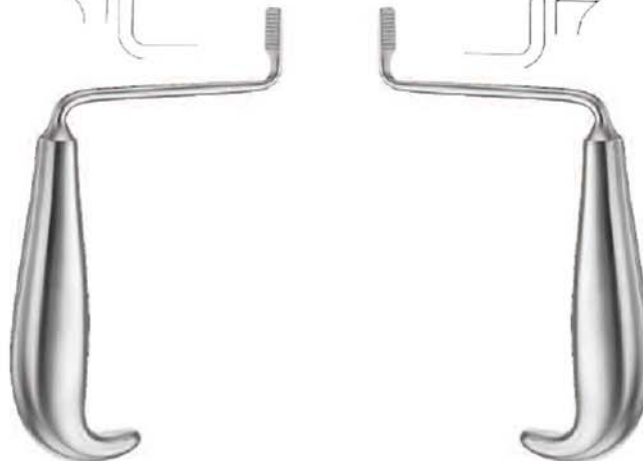

TESSIER
15 cm/6"

Orthopedic

abwärtsgebogen
bent downwards

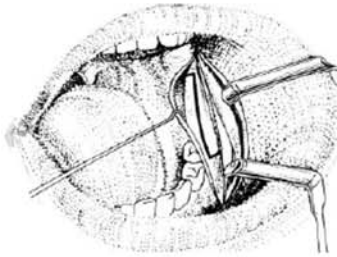

OBWEGESER
24 cm/9½"

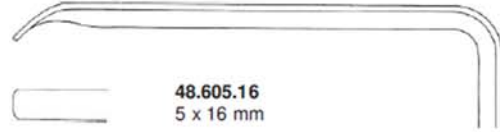

48.605.16
5 x 16 mm



48.605.25
7 x 25 mm



48.605.35
10 x 35 mm



48.605.42
10 x 42 mm



48.605.55
12 x 55 mm



48.605.70
14 x 70 mm



48.605.80
16 x 80 mm

aufwärtsgebogen
bent upwards

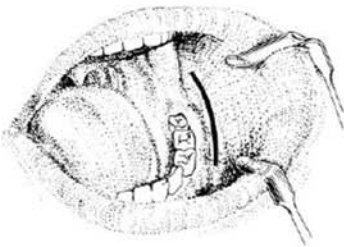

OBWEGESER
24 cm/9½"

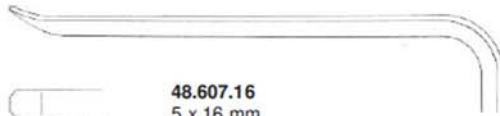

48.607.16
5 x 16 mm



48.607.25
7 x 25 mm



48.607.35
10 x 35 mm



48.607.42
10 x 42 mm



48.607.55
12 x 55 mm



48.607.70
14 x 70 mm



48.607.80
16 x 80 mm



MULTICRAFTS Corporation



Biegsame Spatel
konisch
Malleable retractors
conical

48.781.10
10 - 12 mm
Fig. A

48.781.15
15 - 17 mm
Fig. B

48.781.20
20 - 22 mm
Fig. C

48.781.00
Fig. A/B/C
Satz von 3
Set of 3

TESSIER
22 cm/8 3/4"

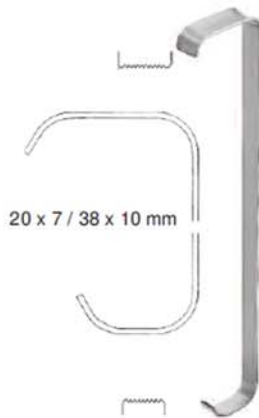

20 x 7 / 38 x 10 mm

TESSIER
48.783.01
15 cm/6"

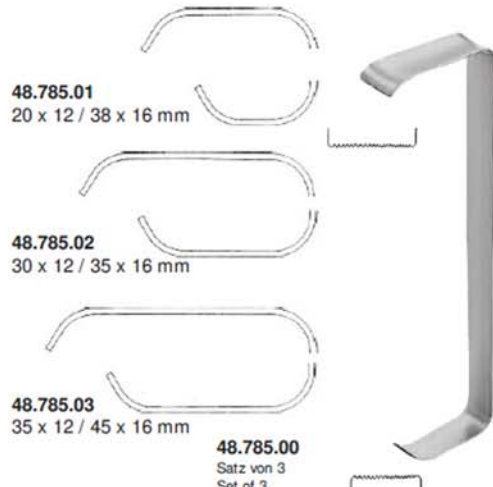

48.785.01
20 x 12 / 38 x 16 mm

48.785.02
30 x 12 / 35 x 16 mm

48.785.03
35 x 12 / 45 x 16 mm

48.785.00
Satz von 3
Set of 3

TESSIER
15,5 cm/6"



50 x 12 / 70 x 16 mm

TESSIER
48.787.50
15,5 cm/6"



48.795.10
10 mm

48.795.17
17,5 mm

48.795.20
20 mm

Sattelhäkchen
schwarzverchromt

Saddle Hooklets
black chrome-plated

TESSIER
14,5 cm/5 3/4"

Orthopedic



Orthopedic



TESSIER
16 cm/6¼"

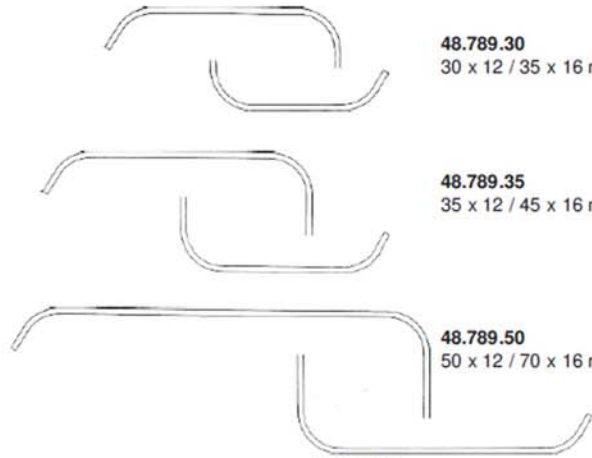

48.789.30
30 x 12 / 35 x 16 mm

48.789.35
35 x 12 / 45 x 16 mm

48.789.50
50 x 12 / 70 x 16 mm

48.789.00
Satz von 3
Set of 3



48.791.01
Fig. 1
8 mm



48.791.02
Fig. 2
10 mm



48.791.03
Fig. 3
7 mm



48.791.05
Fig. 5
8 mm



48.791.06
Fig. 6
12 mm

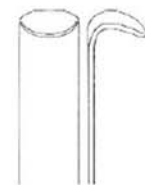

48.791.04
Fig. 4
10 mm



TESSIER
12,5 cm/5"



TESSIER
12,5 cm/5"



MULTICRAFTS Corporation



OBWEGESER
18 cm/7"

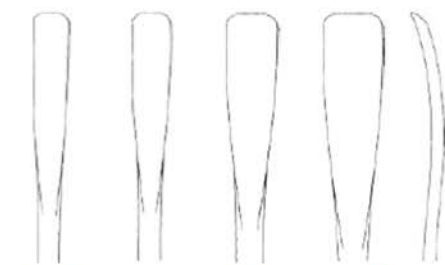

48.608.06 48.608.07 48.608.09 48.608.11
6 mm 7 mm 9 mm 11 mm

winkelig angeschliffen
angled cutting

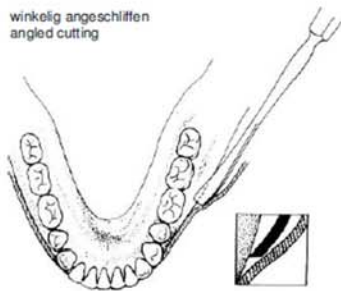

OBWEGESER
18 cm/7"

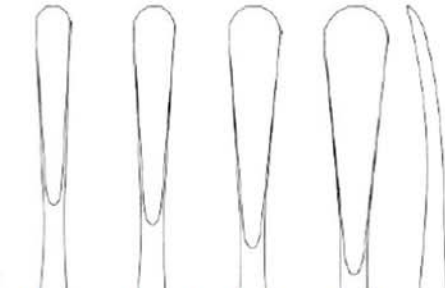

48.609.06 48.609.07 48.609.09 48.609.11
6 mm 7 mm 9 mm 11 mm

flach angeschliffen
flat cutting

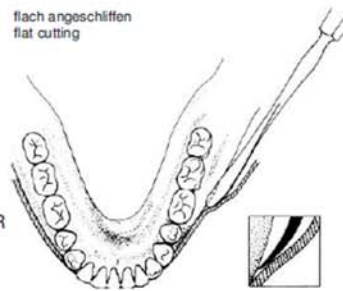

OBWEGESER
20 cm/8"

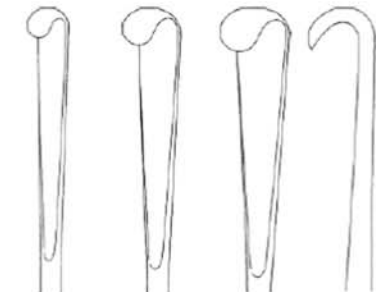

48.611.05 48.611.07 48.611.09
5 mm 7 mm 9 mm

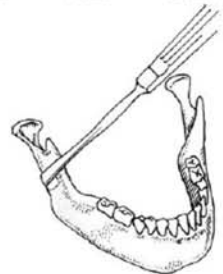

Schwabenschwanz-Raspatorien
Swallowtail Raspatories



OBWEGESER
48.612.01
17,5 cm/7"

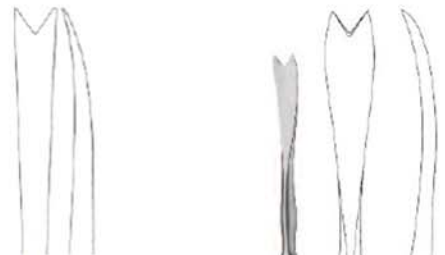

7,5 mm



OBWEGESER
48.612.02
17,5 cm/7"

Orthopedic



MULTICRAFTS Corporation

Orthopedic

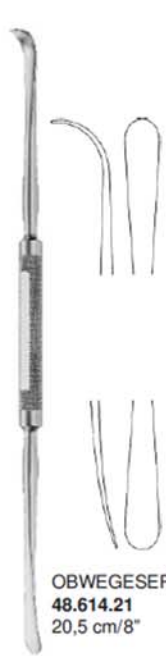

OBWEGESER
48.614.21
20,5 cm/8"



OBWEGESER
48.614.21
21 cm/8¼"



OBWEGESER-FREER
48.619.20
20,5 cm/8"

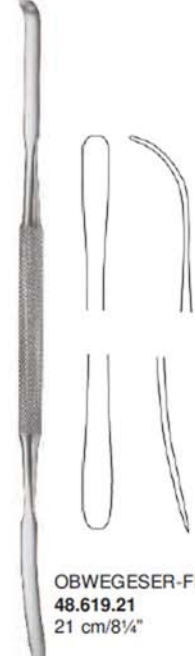

OBWEGESER-FREER
48.619.21
21 cm/8¼"

5,5 mm
scharf
sharf



10 mm
scharf
sharf

OBWEGESER
48.621.10
20,5 cm/8"

5 mm
scharf
sharf



48.623.01
leicht gebogen
slightly curved

48.623.02
stark gebogen
strongly curved

5 mm
stumpf
blunt

SALZBURG
24,5 cm/10"

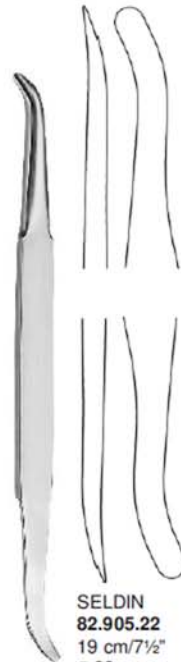

SELDIN
82.905.22
19 cm/7½"
22

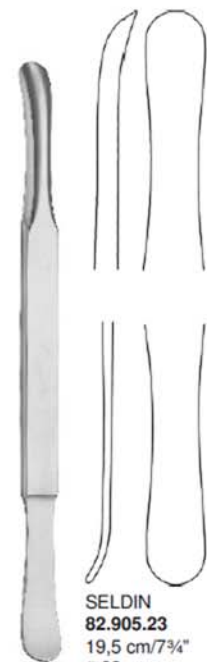

SELDIN
82.905.23
19,5 cm/7¾"
23



MULTICRAFTS Corporation

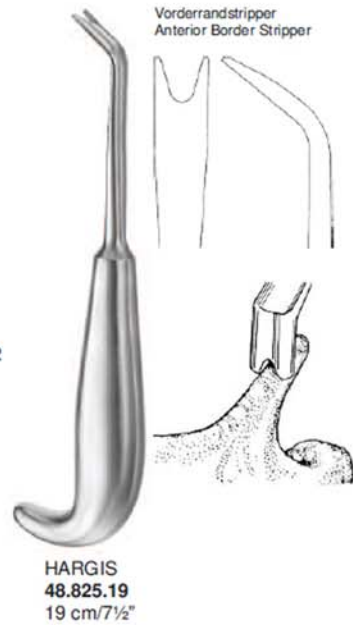
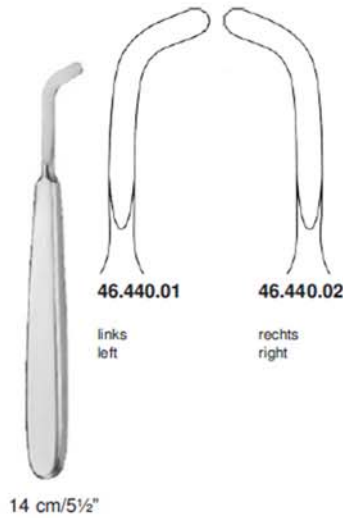
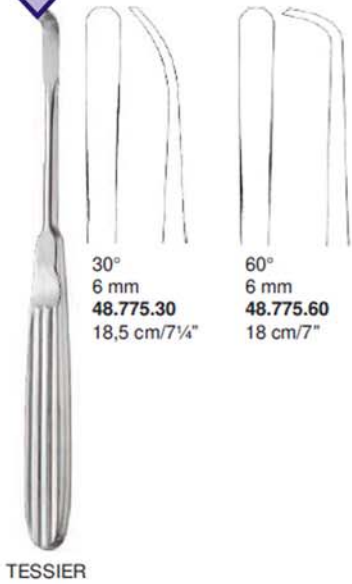

Stripper
Pterygo-massetric sling stripper

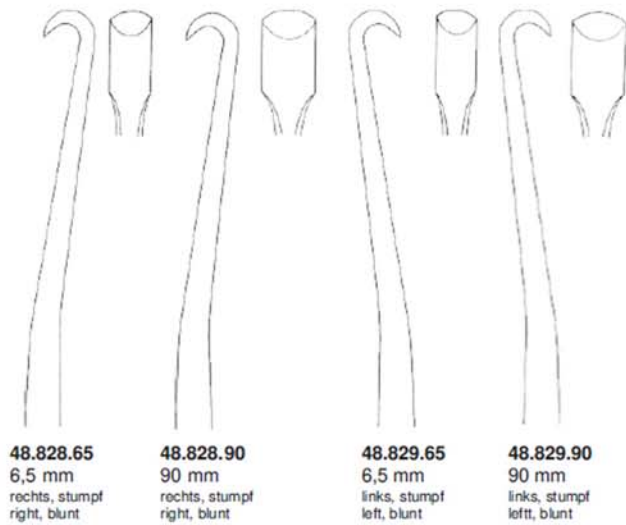
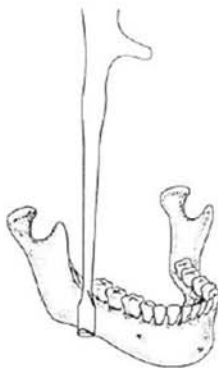

Orthopedic



MULTICRAFTS Corporation

Orthopedic

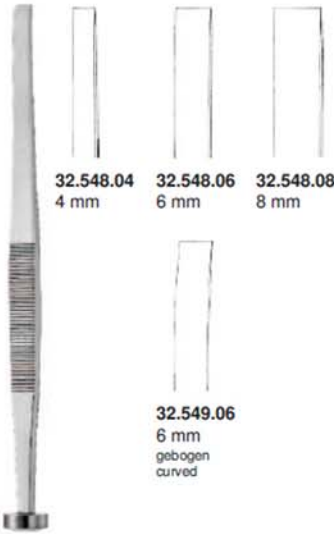

32.548.04 4 mm
32.548.06 6 mm
32.548.08 8 mm

MARCHAC
18,5 cm/7¼"



32.549.06
6 mm
gebogen
curved

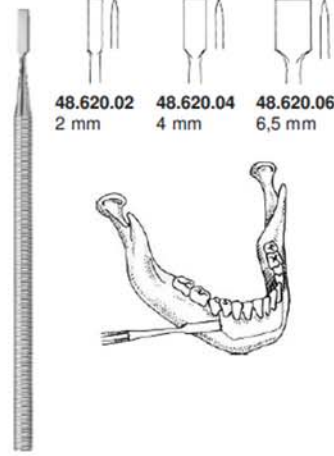

48.620.02 2 mm
48.620.04 4 mm
48.620.06 6,5 mm

OBWEGESER
15 cm/6"

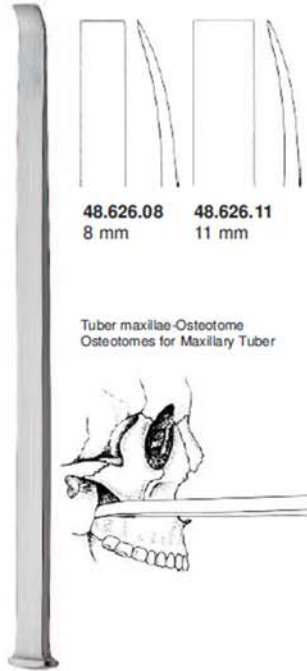
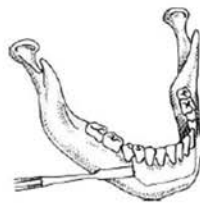

48.626.08 8 mm
48.626.11 11 mm

Tuber maxillae-Osteotome
Osteotomes for Maxillary Tuber

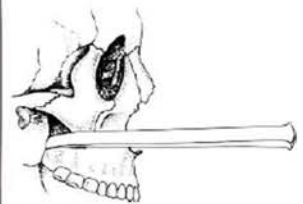

OBWEGESER
23,5 cm/9¼"



48.630.19 4 mm
48.632.19 6 mm

OBWEGESER
18,5 cm/7¼"

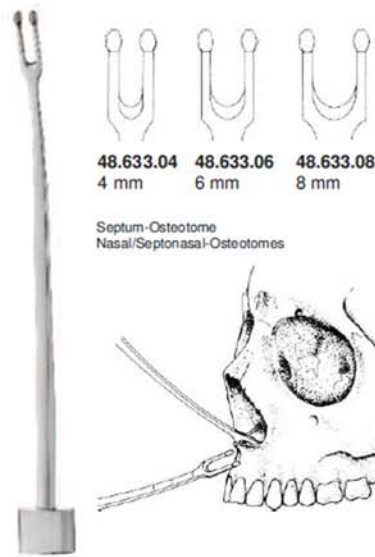

48.633.04 4 mm
48.633.06 6 mm
48.633.08 8 mm

Septum-Osteotome
Nasal/Septonasal-Osteotomes

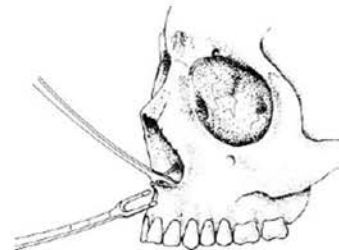

OBWEGESER
18,5 cm/7¼"



MULTICRAFTS Corporation

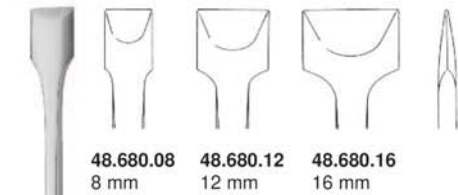

48.680.08 8 mm
48.680.12 12 mm
48.680.16 16 mm



OBWEGESER
22 cm/8 3/4"

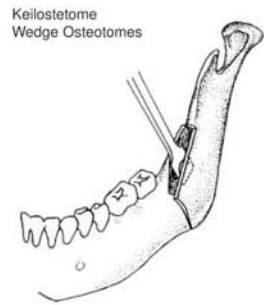

Keilostetome
Wedge Osteotomes

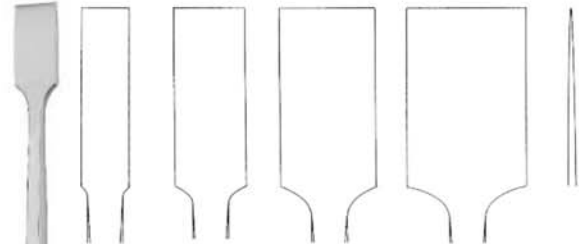

48.682.08 8 mm
48.682.12 12 mm
48.682.16 16 mm
48.682.20 20 mm



OBWEGESER
22 cm/8 3/4"

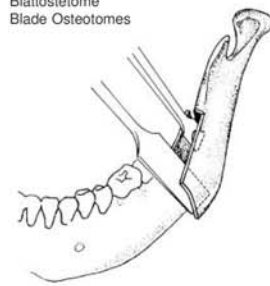

Blattostetome
Blade Osteotomes



48.690.10 10 mm
48.690.20 20 mm



HARGIS
21.5 cm/8 1/2"

Ramus-Spalt -Ostetome
Ramus Splitting Osteotomes



48.692.07 7 mm
48.692.10 10 mm



OBWEGESER
22 cm/8 3/4"

Keilostetome
Wedge Osteotomes

Orthopedic



MULTICRAFTS Corporation

Orthopedic

Alveolarfortsatz-Osteotome
Alveolar Process Osteotomes

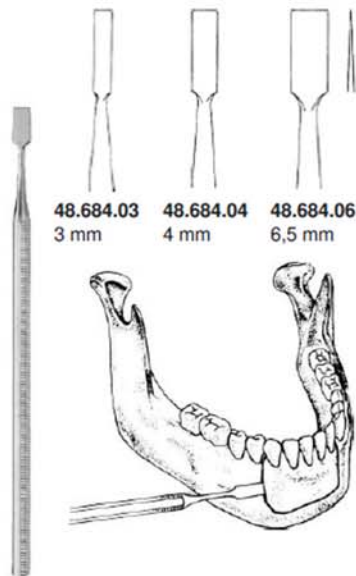

48.684.03 48.684.04 48.684.06
3 mm 4 mm 6,5 mm

OBWEGESER
15,5 cm/6"

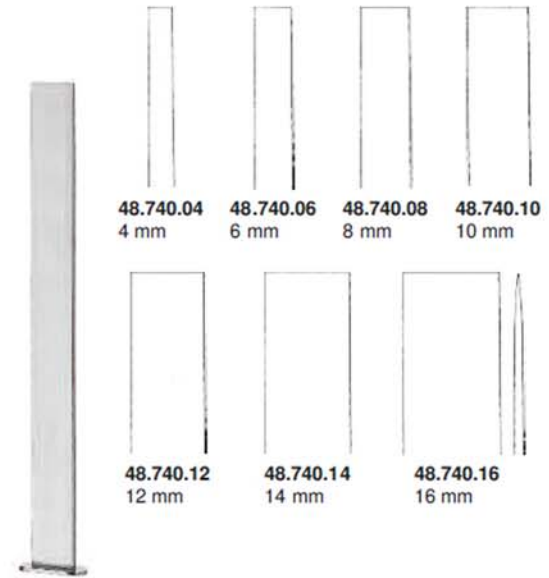

48.740.04 48.740.06 48.740.08 48.740.10
4 mm 6 mm 8 mm 10 mm

48.740.12 48.740.14 48.740.16
12 mm 14 mm 16 mm

DAUTREY-MUNRO
16 cm/6¼"

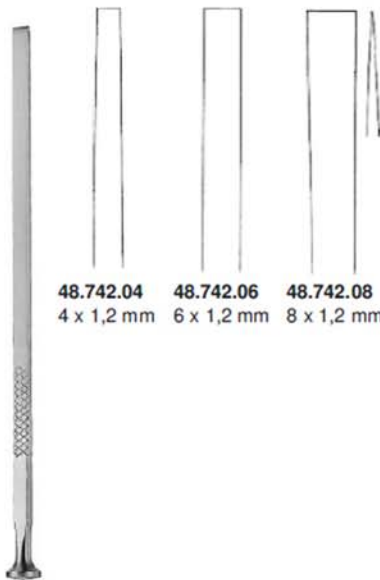

48.742.04 48.742.06 48.742.08
4 x 1,2 mm 6 x 1,2 mm 8 x 1,2 mm

EPKER
18 cm/7"

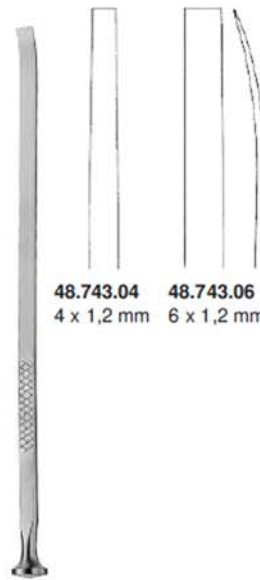

48.743.04 48.743.06
4 x 1,2 mm 6 x 1,2 mm

EPKER
18 cm/7"

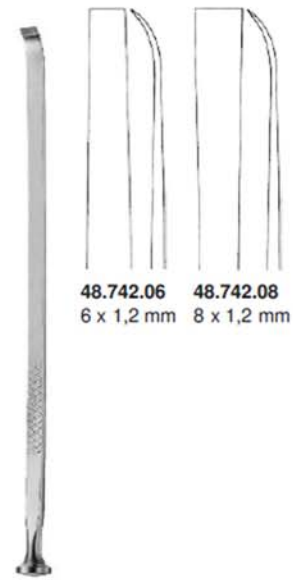

48.742.06 48.742.08
6 x 1,2 mm 8 x 1,2 mm

EPKER
18 cm/7"



MULTICRAFTS Corporation



zur Transplantatentnahme aus Ilium und Tibia
for taking grafts from ilium and tibia

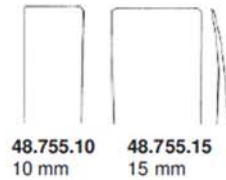
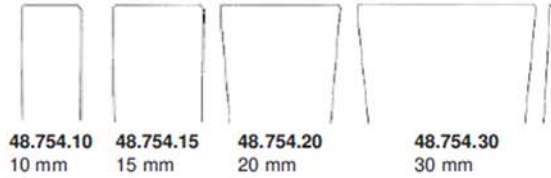

TESSIER
20 cm/7¾"



zur Transplantatentnahme aus der Calva
for taking grafts from the calva

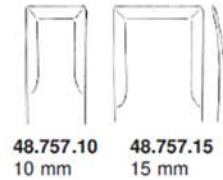
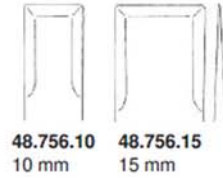

TESSIER
16 cm/6¼"



Kopf head
ø 27 mm
Gewicht Weight
140 g

HAJEK
32.687.22
22 cm/8¾"



Kopf head
ø 30 mm
Gewicht Weight
300 g

COTTLE
32.689.24
19 cm/7½"



Kopf head
ø 25 mm
Gewicht Weight
135 g

32.691.14
18,5 cm/7¼"

Orthopedic



MULTICRAFTS Corporation

Orthopedic



Kopf head
ø 20 mm
Gewicht Weight
140 g

WILLIGER
32.695.14
16,5 cm/6½"



bleigefüllt
lead filled

Kopf head
ø 22 mm
Gewicht Weight
155 g

32.696.19
19 cm/7½"

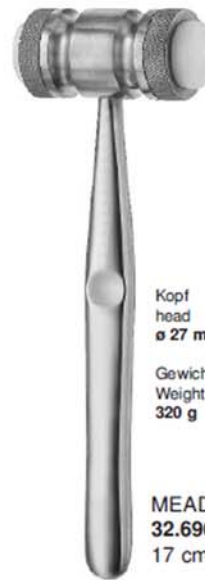

Kopf head
ø 27 mm
Gewicht Weight
320 g

MEAD
32.696.32
17 cm/6¾"



32.697.02

Ersatzbacken (Paar)
Spare Facings (pair)
Kunststoff (Nylon)
plastic (nylon)



MULTICRAFTS Corporation



32.386.20
20 cm/8"

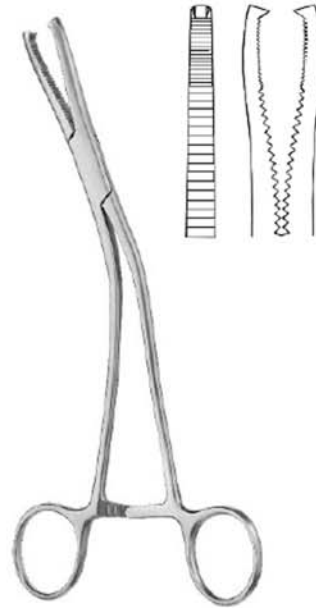

DINGMANN
32.407.19
19 cm/7½"

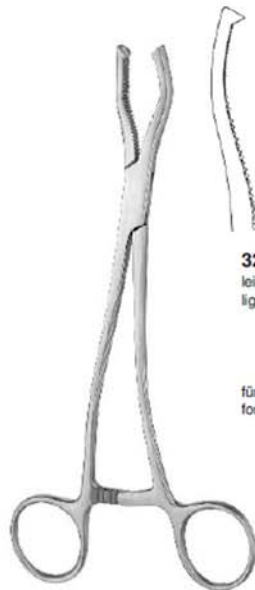

JETER-VAN SICKELS
18 cm/7"

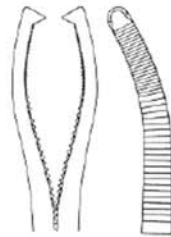

32.408.01
leichtes Modell
light pattern

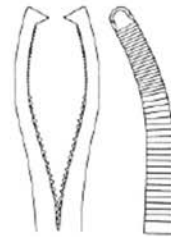

32.408.02
Kräftiges Modell
heavy pattern

für sagittalen Split
for sagittal split procedure

Orthopedic



Orthopedic

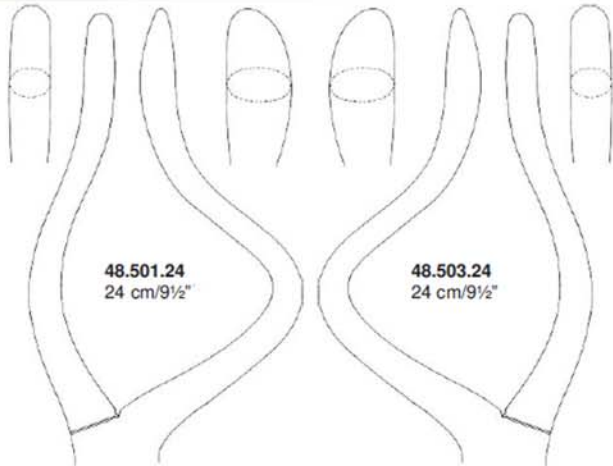

48.501.24
24 cm/9½"

48.503.24
24 cm/9½"



ROWE
links
left

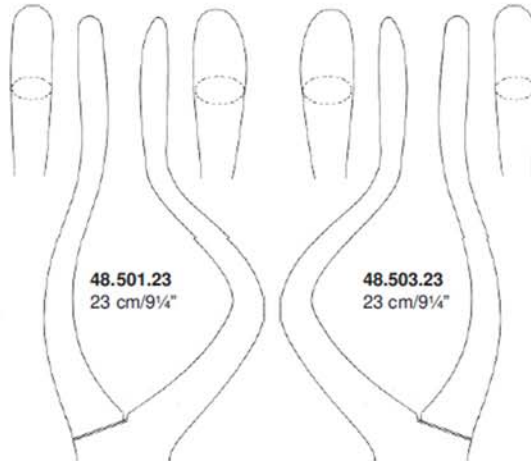

48.501.23
23 cm/9¼"

48.503.23
23 cm/9¼"



ROWE
rechts
right

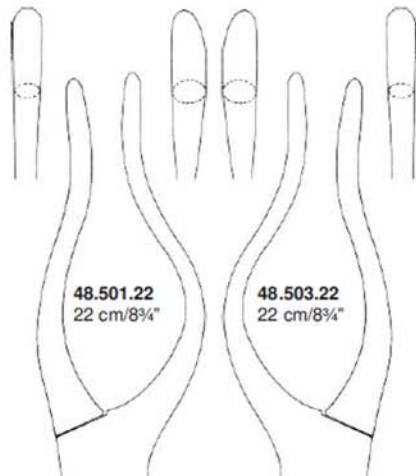

48.501.22
22 cm/8¾"

48.503.22
22 cm/8¾"

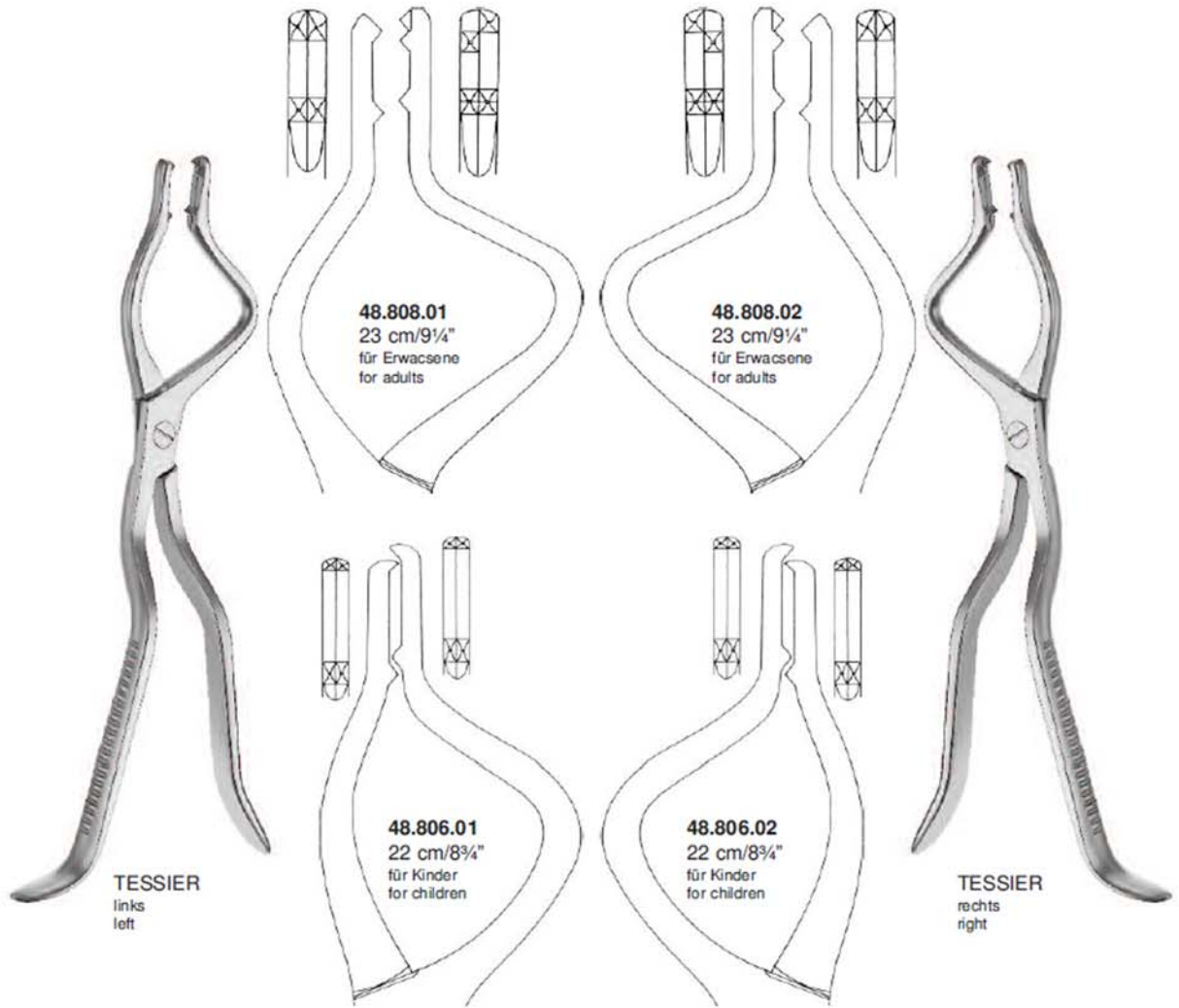

Orthopedic

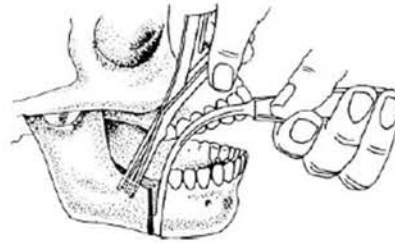

Orthopedic

Knochenformzange
Bone Contouring Forceps

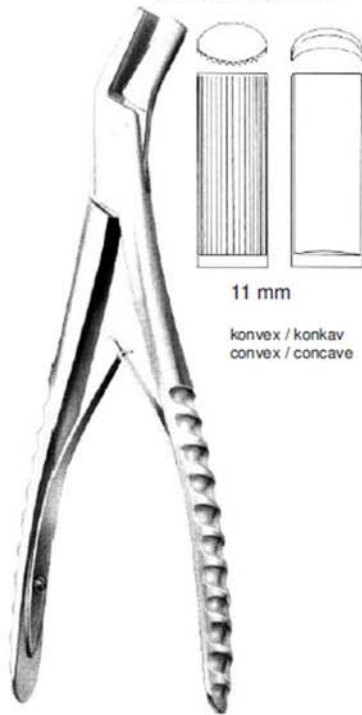

11 mm

konvex / konkav
convex / concave

TESSIER
48.799.22
22 cm/8 3/4"

Spreizzange
Spreading Forceps



7 mm

TESSIER
48.802.18
17,5 cm/7"



12 mm

48.838.20
ohne Sperrer
without ratchet

48.840.20
mit Sperrer
with ratchet



SMITH
48.838.20
23,5 cm/9 1/4"



MULTICRAFTS Corporation

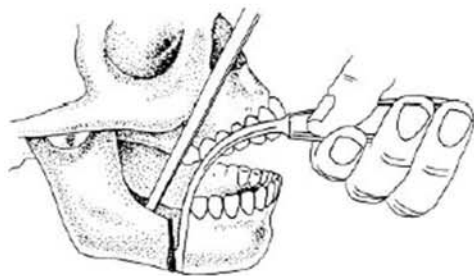

9 mm
rechts
right

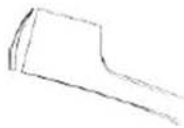

9 mm
links
left



SMITH
48.835.01
18,5 cm/7¼"



SMITH
48.835.02
18,5 cm/7¼"

Orthopedic



MULTICRAFTS Corporation



Draht
Ligature wire

weich, Rolle mit 10 m
soft, coil of 10 m

- | | |
|------------------------------|------------------------------|
| 33.530.02
ø 0,2 mm | 33.530.08
ø 0,8 mm |
| 33.530.03
ø 0,3 mm | 33.530.09
ø 0,9 mm |
| 33.530.04
ø 0,4 mm | 33.530.10
ø 1,0 mm |
| 33.530.05
ø 0,5 mm | 33.530.12
ø 1,2 mm |
| 33.530.06
ø 0,6 mm | 33.530.15
ø 1,5 mm |
| 33.530.07
ø 0,7 mm | |



Drahtbögen
Arch bars

ERICH
48.529.00

Rolle/1 m
Roll/1 m



ERICH
48.529.13
14 cm/5½"

Drahtösenklemme
Wire loop forceps



OBWEGESER
48.650.15
15,5 cm/6¼"

Mit TC-Einsätzen
TC Lined



BARMESH
48.529.13
13,5 cm/5½"

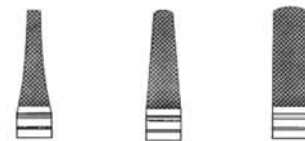

33.533.01

33.533.02

33.533.03



parallel fassend
parallel grip

18 cm/7"

Orthopedic



MULTICRAFTS Corporation



33.601.15
15 cm/6"



BERRY
33.601.19
19 cm/7½"



08.835.12
12 cm/4¾"



33.545.16
17 cm/6¾"



33.545.22
22,5 cm/8¾"

Orthopedic



MULTICRAFTS Corporation



Behälter mit Instrumentarium
Case with Instruments

33.482.00

Behälter ohne Instrumentarium
Case without Instruments

33.482.01

Einsätze
Screw Driver Shafts



Schraubenziehergriff
Screwdriver Handle

33.482.02
14,5 cm / 5½"



33.482.03
14,0 cm / 5½"



33.482.06
14,0 cm / 5½"



33.482.09
14,0 cm / 5½"



33.482.10
14,0 cm / 5½"



JACOBS
Universalbohrfutter
Universal Chuck

33.482.13
7,5 mm / 3"



33.482.18
14,0 cm / 5½"



33.482.19
14,0 cm / 5½"

Orthopedic



MULTICRAFTS Corporation

Tamponstopfer
Gauze Packer

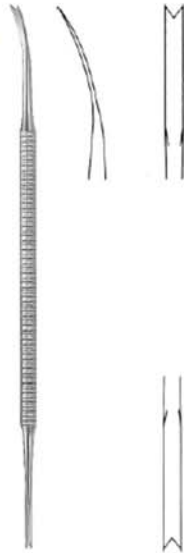

LUNIATSCHEK
50.151.19
19 cm/7½"

Unterkieferahln
Maxillary Awls



OBWEGESSER
48.647.13
13 cm/5"



OBWEGESSER
48.647.15
15 cm/6"



OBWEGESSER
48.647.17
17,5 cm/7"



Jochbogenahle
Zygomatic Arch Awl



OBWEGESSER
48.679.24
24 cm/9½"



gerade
straight



KELSEY FRY
48.636.15
15 cm/6"

gebogen
curved



KELSEY FRY
48.637.18
18 cm/7"

Orthopedic



MULTICRAFTS Corporation



Orthopedic Implants



MULTICRAFTS Corporation



1,5 mm

Länge mm Length mm	Artikel Nr. Cat. No.
6	36.200.06
7	36.200.07
8	36.200.08
9	36.200.09
10	36.200.10
11	36.200.11
12	36.200.12
14	36.200.14
16	36.200.16
18	36.200.18
20	36.200.20

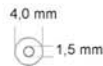

2,0 mm

Länge mm Length mm	Artikel Nr. Cat. No.
6	36.201.06
8	36.201.08
10	36.201.10
12	36.201.12
14	36.201.14
16	36.201.16
18	36.201.18
20	36.201.20
22	36.201.22
24	36.201.24
26	36.201.26
28	36.201.28
30	36.201.30
32	36.201.32
34	36.201.34
36	36.201.36
38	36.201.38



2,7 mm

Länge mm Length mm	Artikel Nr. Cat. No.
6	36.202.06
8	36.202.08
10	36.202.10
12	36.202.12
14	36.202.14
16	36.202.16
18	36.202.18
20	36.202.20
22	36.202.22
24	36.202.24
26	36.202.26
28	36.202.28
30	36.202.30
32	36.202.32
34	36.202.34
36	36.202.36
38	36.202.38
40	36.202.40

Orthopedic



Orthopedic



3,5 mm

Länge mm Length mm	Artikel Nr. Cat. No.
8	36.204.08
10	36.204.10
12	36.204.12
14	36.204.14
16	36.204.16
18	36.204.18
20	36.204.20
22	36.204.22
24	36.204.24
26	36.204.26
28	36.204.28
30	36.204.30
32	36.204.32
34	36.204.34
36	36.204.36
40	36.204.40
45	36.204.45
50	36.204.50
55	36.204.55
60	36.204.60
65	36.204.65
70	36.204.70
75	36.204.75
80	36.204.80
85	36.204.85
90	36.204.90
95	36.204.95



MULTICRAFTS Corporation



3,5 mm

Länge mm Length mm	Artikel Nr. Cat. No.
8	36.206.08
10	36.206.10
12	36.206.12
14	36.206.14
16	36.206.16
18	36.206.18
20	36.206.20
22	36.206.22
24	36.206.24
26	36.206.26
28	36.206.28
30	36.206.30
32	36.206.32
34	36.206.34
36	36.206.36
40	36.206.40
45	36.206.45
50	36.206.50
55	36.206.55
60	36.206.60
65	36.206.65



4,0 mm

Länge mm Length mm	Gewindelänge mm Length of thread mm	Artikel Nr. Cat. No.
10	5	36.207.10
12	5	36.207.12
14	5	36.207.14
16	6	36.207.16
18	7	36.207.18
20	8	36.207.20
22	9	36.207.22
24	10	36.207.24
26	12	36.207.26
28	14	36.207.28
30	14	36.207.30
35	14	36.207.35
40	14	36.207.40
45	15	36.207.45
50	15	36.207.50

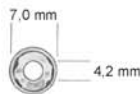

Unterlagscheibe
Washer

36.219.98



Unterlagscheibe
Washer

36.219.98

Orthopedic



Orthopedic



4,5 mm

Länge mm Length mm	Artikel Nr. Cat. No.
14	36.214.14
16	36.214.16
18	36.214.18
20	36.214.20
22	36.214.22
24	36.214.24
26	36.214.26
28	36.214.28
30	36.214.30
32	36.214.32
34	36.214.34
36	36.214.36
38	36.214.38
40	36.214.40
42	36.214.42
44	36.214.44
46	36.214.46
48	36.214.48
50	36.214.50
52	36.214.52
54	36.214.54
56	36.214.56
60	36.214.60
62	36.214.62
64	36.214.64
70	36.214.70
80	36.214.80



Mutter
Nut

36.219.96



Schraubenschlüssel
Wrench

36.608.80

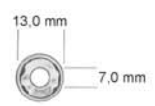
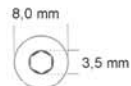

Unterlagscheibe
Washer

36.219.99

Länge mm Length mm	Artikel Nr. Cat. No.
20	36.215.20
25	36.215.25
30	36.215.30
35	36.215.35
40	36.215.40
45	36.215.45
50	36.215.50
55	36.215.55
60	36.215.60
65	36.215.65
70	36.215.70
80	36.215.80

Orthopedic



MULTICRAFTS Corporation

Orthopedic

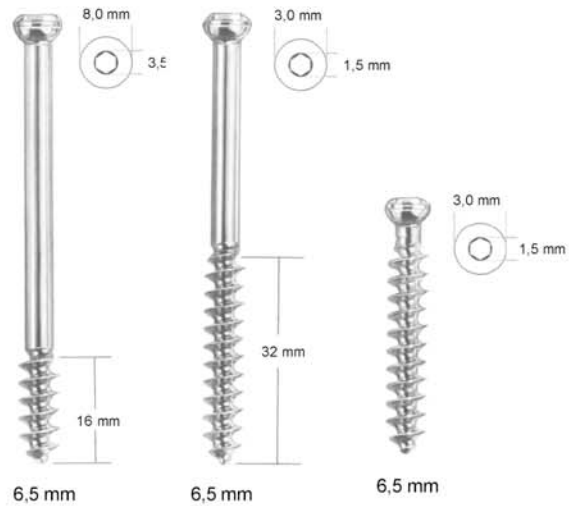

Unterlagscheibe
Washer

36.219.99

Länge mm Length mm	Artikel Nr. Cat. No.	Artikel Nr. Cat. No.	Artikel Nr. Cat. No.
25			36.218.25
30	36.216.30		36.218.30
35	36.216.35		36.218.35
40	36.216.40		36.218.40
45	36.216.45	36.217.45	36.218.45
50	36.216.50	36.217.50	36.218.50
55	36.216.55	36.217.55	36.218.55
60	36.216.60	36.217.60	36.218.60
65	36.216.65	36.217.65	36.218.65
70	36.216.70	36.217.70	36.218.70
75	36.216.75	36.217.75	36.218.75
80	36.216.80	36.217.80	36.218.80
85	36.216.85	36.217.85	36.218.85
90	36.216.90	36.217.90	36.218.90
95	36.216.95	36.217.95	36.218.95
100	36.216.00	36.217.00	36.218.00
105	36.216.05	36.217.05	36.218.05
110	36.216.10	36.217.10	36.218.10
115	36.216.15	36.217.15	
120	36.216.20	36.217.20	



MULTICRAFTS Corporation

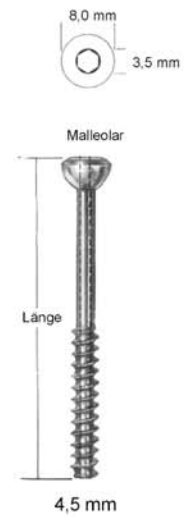
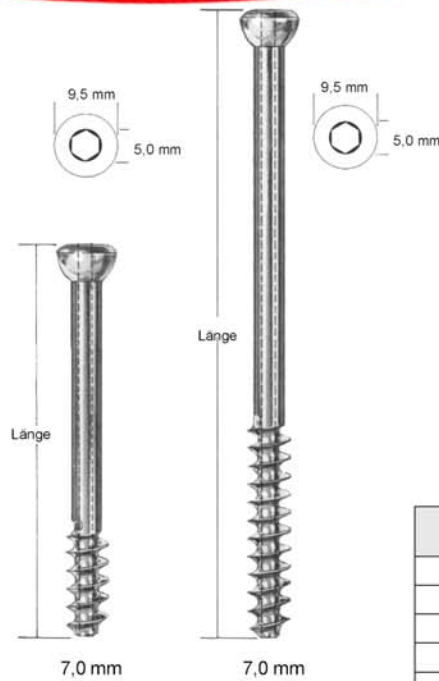

Länge mm Length mm	Gewindelänge mm Thread Length mm	Artikel Nr. Cat. No.
25	12	36.115.25
30	15	36.115.30
35	18	36.115.35
40	20	36.115.40
45	22	36.115.45
50	24	36.115.50
55	26	36.115.55

Länge mm Length mm	Artikel Nr. Cat. No.	Artikel Nr. Cat. No.
25	36.116.25	
30	36.116.30	
35	36.116.35	
40	36.116.40	36.118.40
45	36.116.45	36.118.45
50	36.116.50	36.118.50
55	36.116.55	36.118.55
60	36.116.60	36.118.60
65	36.116.65	36.118.65
70	36.116.70	36.118.70
75	36.116.75	36.118.75
80	36.116.80	36.118.80
85	36.116.85	36.118.85
90	36.116.90	36.118.90
95	36.116.95	36.118.95
100	36.117.00	36.119.00
105	36.117.05	36.119.05
110	36.117.10	36.119.10
115	36.117.15	36.119.15
120	36.117.20	36.119.20

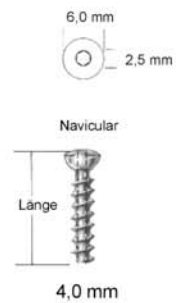

Länge mm Length mm	Gewindelänge mm Thread Length mm	Artikel Nr. Cat. No.
10	4	36.107.10
12	4	36.107.12
14	4	36.107.14
16	5	36.107.16
18	6	36.107.18
20	7	36.107.20
22	8	36.107.22
24	9	36.107.24
26	10	36.107.26
28	10	36.107.28
30	10	36.107.30



Unterlagscheibe für Hohlrauben
Washer for cannulated screws

- 36.120.13 ø 13 mm
- 36.120.16 ø 16 mm
- 36.120.19 ø 19 mm

Orthopedic



MULTICRAFTS Corporation

Orthopedic



Führungsspieß \varnothing 1,6 mm
für Hohlsschrauben \varnothing 7,0 mm
Guide wire \varnothing 1.6 mm
for hollow screws \varnothing 7.0 mm

33.722.10 100 mm
33.722.15 150 mm
33.722.20 200 mm



Führungsspieß \varnothing 1,0 mm für
Malleolar- und Navicularschrauben
Guide wire \varnothing 1.0 mm for
Malleolar and Navicular screws

33.724.10 100 mm
33.724.15 150 mm



Corticalfräser
Cortex Reamer

33.802.45 \varnothing 4,5 mm
33.802.70 \varnothing 7,0 mm



Flachbohrer \varnothing 5,0 mm
Flat Drill \varnothing 5.0 mm

33.810.05



Gewindeschneider \varnothing 4,5 mm - \varnothing 7,0 mm
Tap \varnothing 4.5 mm - \varnothing 7.0 mm

33.812.45 \varnothing 4,5 mm
33.812.70 \varnothing 7,0 mm



Beide Plattenden mit Nut zum Einhängen des Plattenspanners
Both end are notched to hold tension device

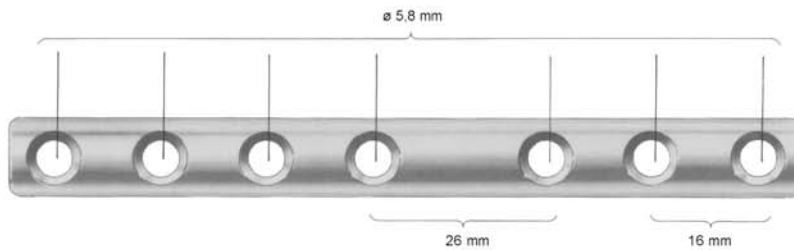
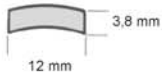

Länge mm Length mm	Lochanzahl No. of holes	Artikel Nr. Cat. No.
39	2	36.223.02
55	3	36.223.03
71	4	36.223.04
87	5	36.223.05
103	6	36.223.06
119	7	36.223.07
135	8	36.223.08
151	9	36.223.09
167	10	36.223.10
183	11	36.223.11
199	12	36.223.12
215	13	36.223.13
231	14	36.223.14
247	15	36.223.15
263	16	36.223.16
279	17	36.223.17
295	18	36.223.18

Passende Schrauben / Recommended Screws:	
Kortikal ø 4,5 mm	36.214.14 - 36.214.80
Malleolar ø 4,5 mm	36.215.20 - 36.215.80
Spongiosa ø 6,5 mm	36.216.00 - 36.216.95
Cancellous ø 6,5 mm	36.217.00 - 36.217.95
	36.218.00 - 36.218.95



Beide Plattendenen mit Nut zum Einhängen des Plattenspanners
Both end are notched to hold tension device

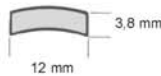

Länge mm Length mm	Lochanzahl No. of holes	Artikel Nr. Cat. No.
39	2	36.224.02
55	3	36.224.03
71	4	36.224.04
87	5	36.224.05
103	6	36.224.06
119	7	36.224.07
135	8	36.224.08
151	9	36.224.09
167	10	36.224.10
183	11	36.224.11
199	12	36.224.12
215	13	36.224.13
231	14	36.224.14
247	15	36.224.15
263	16	36.224.16

Passende Schrauben / Recommended Screws:	
Kortikal ø 4,5 mm	36.214.14 - 36.214.80
Malleolar ø 4,5 mm	36.215.20 - 36.215.80
Spongiosa ø 6,5 mm	36.216.00 - 36.216.95
Cancellous ø 6,5 mm	36.217.00 - 36.217.95
	36.218.00 - 36.218.95



Beide Plattenden mit Nut zum Einhängen des Plattenspanners
Both end are notched to hold tension device

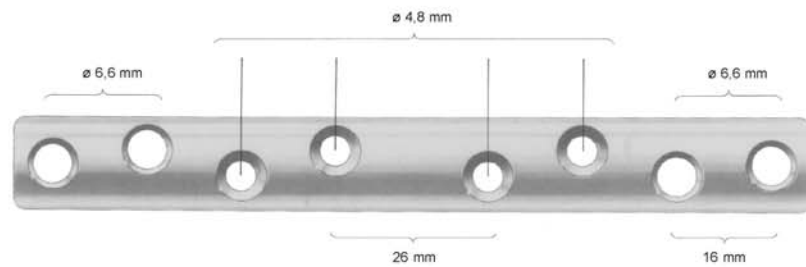
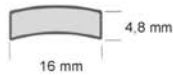

Länge mm Length mm	Lochanzahl No. of holes	Artikel Nr. Cat. No.
103	6	36.225.06
119	7	36.225.07
135	8	36.225.08
151	9	36.225.09
167	10	36.225.10
183	11	36.225.11
199	12	36.225.12
215	13	36.225.13
231	14	36.225.14
247	15	36.225.15
263	16	36.225.16
295	18	36.225.18

Passende Schrauben / Recommended Screws:	
Kortikal ø 4,5 mm	36.214.14 - 36.214.80
Malleolar ø 4,5 mm	36.215.20 - 36.215.80
Spongiosa ø 6,5 mm	36.216.00 - 36.216.95
Cancellous ø 6,5 mm	36.217.00 - 36.217.95
	36.218.00 - 36.218.95



Beide Plattenden mit Nut zum Einhängen des Plattenspanners
Both end are notched to hold tension device

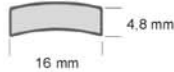

25 mm

16 mm

Länge mm Length mm	Lochanzahl No. of holes	Artikel Nr. Cat. No.
103	6	36.226.06
119	7	36.226.07
135	8	36.226.08
151	9	36.226.09
167	10	36.226.10
183	11	36.226.11
199	12	36.226.12
215	13	36.226.13
231	14	36.226.14
247	15	36.226.15
263	16	36.226.16
295	18	36.226.18

Passende Schrauben / Recommended Screws:

Kortikal ø 4,5 mm	36.214.14 - 36.214.80
Malleolar ø 4,5 mm	36.215.20 - 36.215.80
Spongiosa ø 6,5 mm	36.216.00 - 36.216.95
Cancelous ø 6,5 mm	36.217.00 - 36.217.95
	36.218.00 - 36.218.95

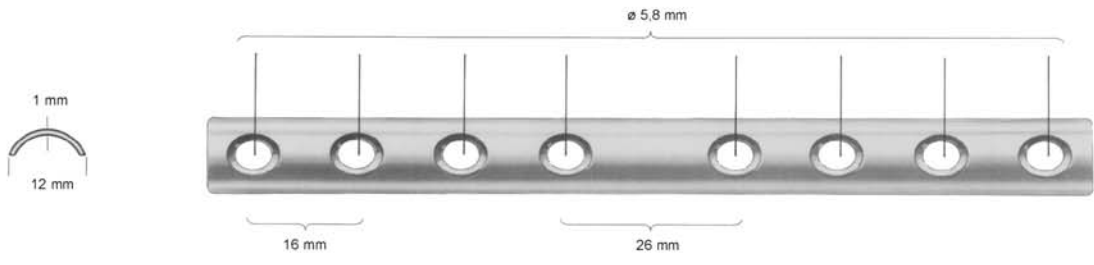

Länge mm Length mm	Lochanzahl No. of holes	Artikel Nr. Cat. No.
39	2	36.222.02
55	3	36.222.03
71	4	36.222.04
87	5	36.222.05
103	6	36.222.06
119	7	36.222.07
135	8	36.222.08
151	9	36.222.09
167	10	36.222.10
183	11	36.222.11
199	12	36.222.12

Passende Schrauben / Recommended Screws:	
Kortikal $\varnothing 4,5 \text{ mm}$	36.214.14 - 36.214.80
Malleolar $\varnothing 4,5 \text{ mm}$	36.215.20 - 36.215.80

Orthopedic

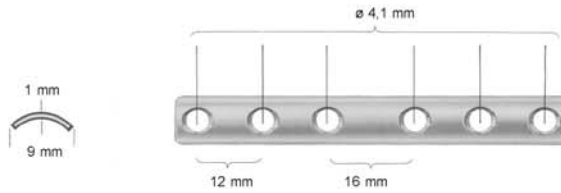

Länge mm Length mm	Lochanzahl No. of holes	Artikel Nr. Cat. No.
25	2	36.241.02
37	3	36.241.03
49	4	36.241.04
61	5	36.241.05
73	6	36.241.06
85	7	36.241.07
97	8	36.241.08

Passende Schrauben / Recommended Screws:	
Kortikal \varnothing 3,5 mm	36.204.14 - 36.204.85
Spongiosa \varnothing 3,5 mm Cancellous \varnothing 3,5 mm	36.206.08 - 36.206.60
Spongiosa \varnothing 4,0 mm Cancellous \varnothing 4,0 mm	36.207.10 - 36.207.50

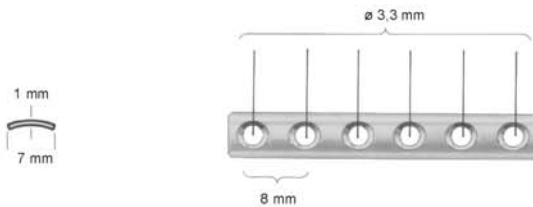

Länge mm Length mm	Lochanzahl No. of holes	Artikel Nr. Cat. No.
23	3	36.242.13
31	4	36.242.14
39	5	36.242.15
47	6	36.242.16
55	7	36.242.17
63	8	36.242.18
71	9	36.242.19

Passende Schrauben / Recommended Screws:	
Kortikal \varnothing 2,7 mm	36.202.06 - 36.202.40



MULTICRAFTS Corporation

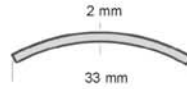

Länge mm Length mm	Lochanzahl No. of holes	Artikel Nr. Cat. No.
100	5	36.510.05
120	6	36.512.06

Passende Schrauben / Recommended Screws:	
Kortikal ø 4,5 mm	36.214.14 - 36.214.80

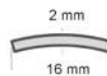
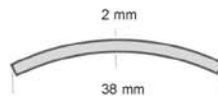

Länge mm Length mm	Lochanzahl No. of holes	Artikel Nr. Cat. No.
68	3	36.516.03
84	4	36.516.04
105	5	36.516.05
116	6	36.516.06
148	8	36.516.08

Passende Schrauben / Recommended Screws:	
Kortikal ø 4,5 mm	36.214.14 - 36.214.80

Orthopedic

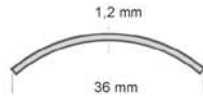

Länge mm Length mm	Lochanzahl No. of holes	Artikel Nr. Cat. No.
88	3	36.520.03
105	4	36.520.04

Passende Schrauben / Recommended Screws:	
Kopf / Head	
Spongiosa \varnothing 3,5 mm Cancellous \varnothing 3,5 mm	36.206.08 - 36.206.65
Schaft / Shaft	
Kortikal \varnothing 4,5 mm	36.214.14 - 36.214.80

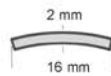
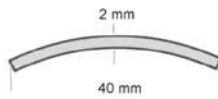

Länge mm Length mm	Lochanzahl No. of holes	Artikel Nr. Cat. No.
80	4	36.526.04
103	5	36.526.05
116	6	36.526.06

Passende Schrauben / Recommended Screws:	
Kortikal \varnothing 4,5 mm	36.214.14 - 36.214.80



MULTICRAFTS Corporation

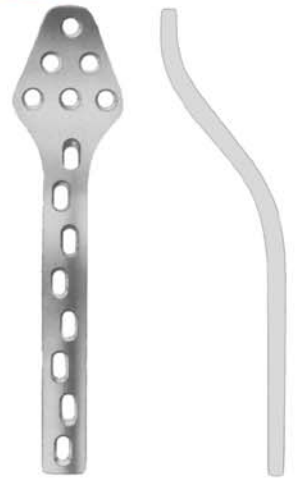
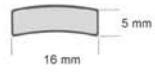

Länge mm Length mm	Lochanzahl No. of holes	Artikel Nr. Cat. No.
170	8	36.445.08
186	9	36.445.09
202	10	36.445.10
218	11	36.445.11

Passende Schrauben / Recommended Screws:	
Kortikal ø 3,5 mm	36.214.14 - 36.214.80
Malleolar ø 4,5 mm	36.215.20 - 36.215.80
Spongiosa ø 6,5 mm	36.216.00 - 36.216.95
Cancelous ø 6,5 mm	36.217.00 - 36.217.95
	36.218.00 - 36.218.95

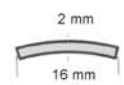
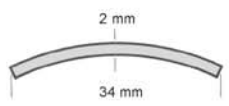

Länge mm Length mm	Lochanzahl No. of holes	Artikel Nr. Cat. No.
87	4 links, left	36.529.01
87	4 rechts, right	36.529.02

Passende Schrauben / Recommended Screws:	
Kortikal ø 4,5 mm	36.214.14 - 36.214.80

Orthopedic



MULTICRAFTS Corporation

Orthopedic



Länge mm Length mm	Lochanzahl No. of holes	Artikel Nr. Cat. No.
45	3 x 3	36.340.39
58	4 x 4	36.340.56
66	3 x 5	36.340.47
78	4 x 6	36.340.78

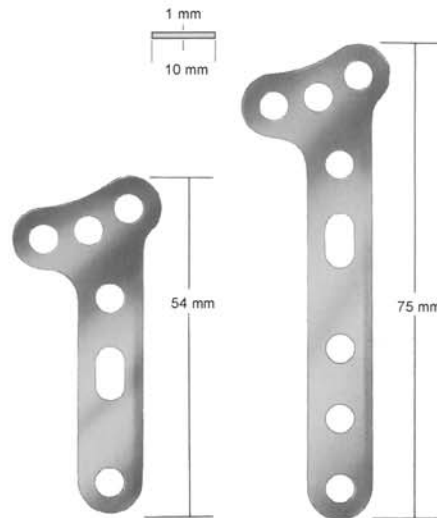

Länge mm Length mm	Lochanzahl No. of holes	Artikel Nr. Cat. No.
54	3 x 3	36.341.39
75	3 x 5	36.341.47

Passende Schrauben / Recommended Screws:	
Kortikal ø 3,5 mm	36.204.10 - 36.204.95



MULTICRAFTS Corporation

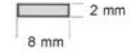
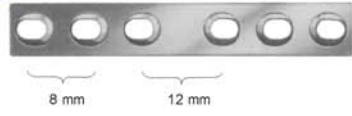

36.244.02 - 36.244.06

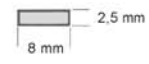

36.244.07 - 36.244.12

Länge mm Length mm	Lochanzahl No. of holes	Artikel Nr. Cat. No.
20	2	36.244.02
36	4	36.244.04
44	5	36.244.05
52	6	36.244.06
60	7	36.244.07
68	8	36.244.08
76	9	36.244.09
84	10	36.244.10
100	12	36.244.12

Passende Schrauben / Recommended Screws:	
Kortikal ø 2,7 mm	36.202.06 - 36.202.40

Orthopedic

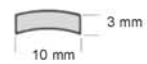

Länge mm Length mm	Lochanzahl No. of holes	Artikel Nr. Cat. No.
25	2	36.248.02
37	3	36.248.03
49	4	36.248.04
61	5	36.248.05
73	6	36.248.06
85	7	36.248.07
97	8	36.248.08
121	10	36.248.10
145	12	36.248.12

Passende Schrauben / Recommended Screws:	
Kortikal ø 3,5 mm	36.204.10 - 36.204.95
Spongiosa ø 3,5 mm	36.206.08 - 36.206.65



MULTICRAFTS Corporation

Orthopedic

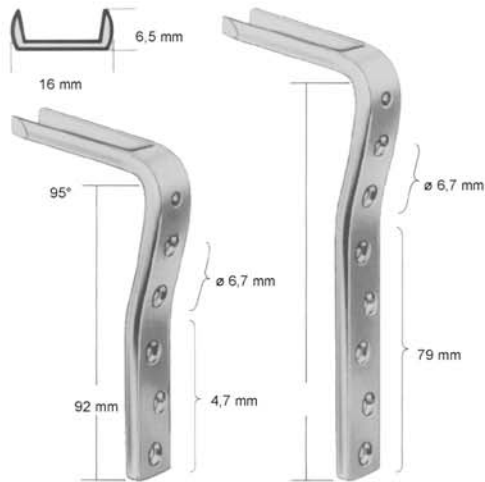

Plattenlänge 92 mm · Length of plate 92 mm		
Klingenlänge mm Length of blades mm	Lochanzahl No. of holes	Artikel Nr. Cat. No.
50	5	36.231.50
60	5	36.231.52
70	5	36.231.54
80	5	36.231.56

Plattenlänge 124 mm · Length of plate 124 mm		
Klingenlänge mm Length of blades mm	Lochanzahl No. of holes	Artikel Nr. Cat. No.
50	7	36.231.70
60	7	36.231.72
70	7	36.231.74
80	7	36.231.76

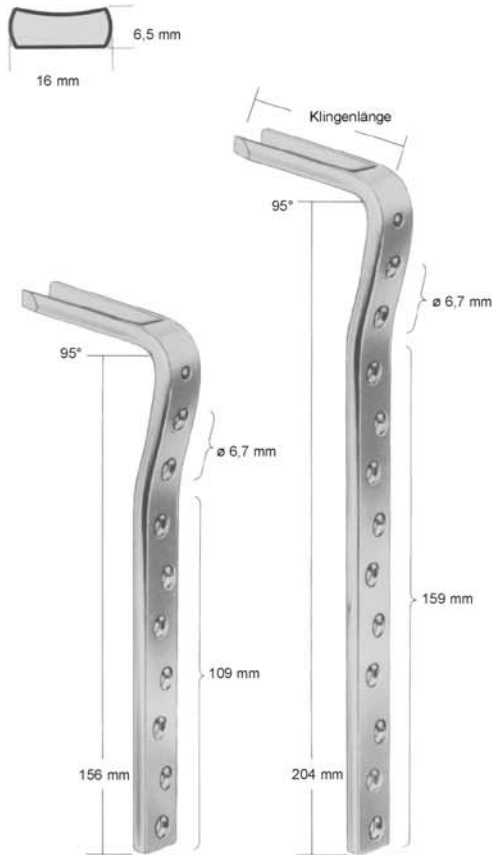

Plattenlänge 156 mm · Length of plate 156 mm		
Klingenlänge mm Length of blades mm	Lochanzahl No. of holes	Artikel Nr. Cat. No.
50	9	36.231.90
60	9	36.231.92
70	9	36.231.94
80	9	36.231.96

Plattenlänge 204 mm · Length of plate 204 mm		
Klingenlänge mm Length of blades mm	Lochanzahl No. of holes	Artikel Nr. Cat. No.
50	12	36.231.20
60	12	36.231.22
70	12	36.231.24
80	12	36.231.26

Passende Schrauben / Recommended Screws:	
Kortikal \varnothing 4,5 mm	36.214.14 - 36.214.80
Malleolar \varnothing 4,5 mm	36.215.20 - 36.215.80
Spongiosa / Cancellous \varnothing 6,5 mm	für die oberen 2 Löcher geeignet the 2 holes next blade accepted



MULTICRAFTS Corporation

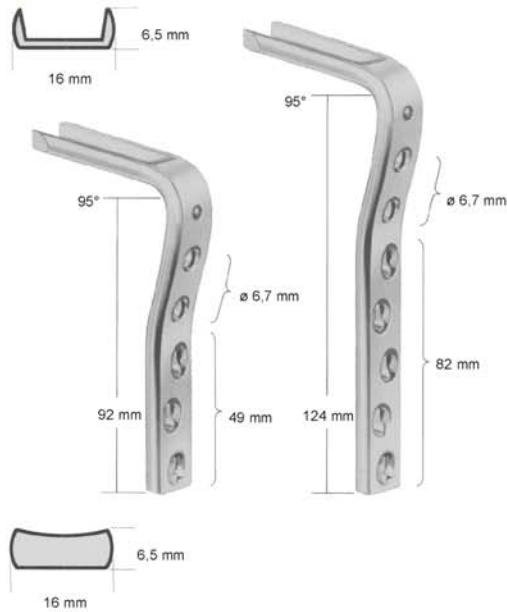

Plattenlänge 92 mm · Length of plate 92 mm		
Klingenlänge mm Length of blades mm	Lochanzahl No. of holes	Artikel Nr. Cat. No.
50	5	36.237.50
60	5	36.237.52
70	5	36.237.54
80	5	36.237.56

Plattenlänge 124 mm · Length of plate 124 mm		
Klingenlänge mm Length of blades mm	Lochanzahl No. of holes	Artikel Nr. Cat. No.
50	7	36.237.70
60	7	36.237.72
70	7	36.237.74
80	7	36.237.76

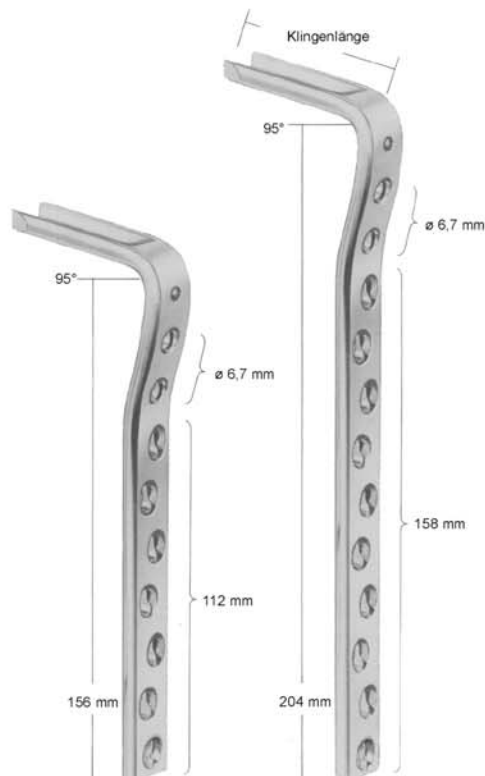

Plattenlänge 156 mm · Length of plate 156 mm		
Klingenlänge mm Length of blades mm	Lochanzahl No. of holes	Artikel Nr. Cat. No.
50	9	36.237.90
60	9	36.237.92
70	9	36.237.94
80	9	36.237.96

Plattenlänge 204 mm · Length of plate 204 mm		
Klingenlänge mm Length of blades mm	Lochanzahl No. of holes	Artikel Nr. Cat. No.
50	12	36.237.20
60	12	36.237.22
70	12	36.237.24
80	12	36.237.26

Passende Schrauben / Recommended Screws:	
Kortikal \varnothing 4,5 mm	36.214.14 - 36.214.80
Malleolar \varnothing 4,5 mm	36.215.20 - 36.215.80
Spongiosa / Cancellous \varnothing 6,5 mm	für die oberen 2 Löcher geeignet the 2 holes next blade accepted

Orthopedic



Orthopedic



Klingenlänge mm Length of blades mm	Artikel Nr. Cat. No.
70	36.239.70
75	36.239.75
80	36.239.80
85	36.239.85
90	36.239.90
95	36.239.95
100	36.240.00
105	36.240.05
110	36.240.10

Passende Schrauben / Recommended Screws:	
Kortikal ø 4,5 mm	36.214.14 - 36.214.80



MULTICRAFTS Corporation

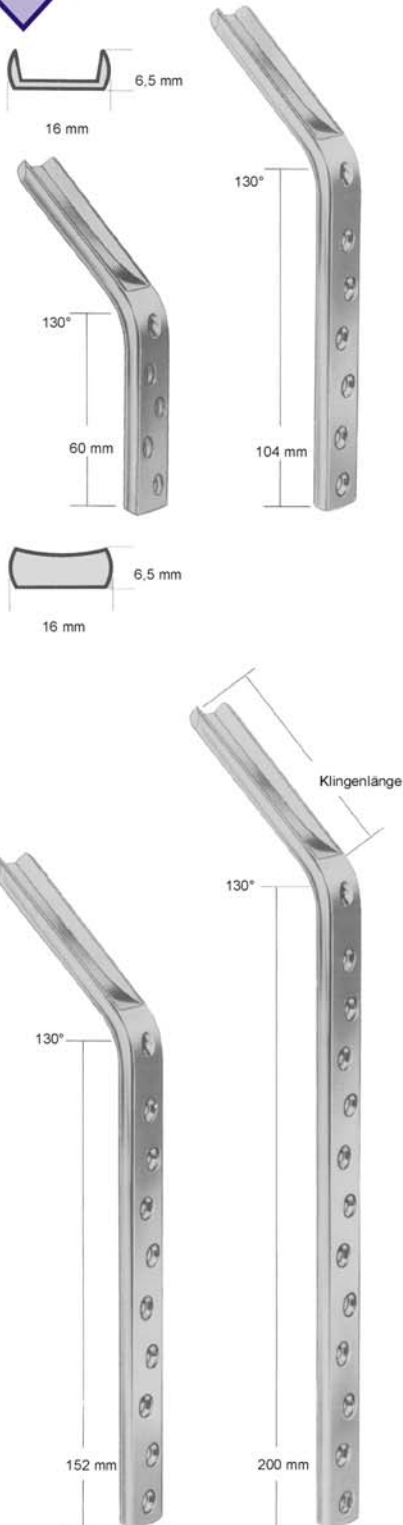

Plattenlänge 60 mm · Length of plate 60 mm		
Klingenlänge mm Length of blades mm	Lochanzahl No. of holes	Artikel Nr. Cat. No.
50	4	36.233.36
60	4	36.233.38
70	4	36.233.44
75	4	36.233.45
80	4	36.233.46
85	4	36.233.47
90	4	36.233.48
95	4	36.233.49
100	4	36.233.40
105	4	36.233.41
110	4	36.233.42

Plattenlänge 104 mm · Length of plate 104 mm		
Klingenlänge mm Length of blades mm	Lochanzahl No. of holes	Artikel Nr. Cat. No.
50	6	36.233.60
60	6	36.233.62
70	6	36.233.64
80	6	36.233.66
90	6	36.233.68

Plattenlänge 152 mm · Length of plate 152 mm		
Klingenlänge mm Length of blades mm	Lochanzahl No. of holes	Artikel Nr. Cat. No.
70	9	36.233.94
80	9	36.233.96
90	9	36.233.98

Plattenlänge 200 mm · Length of plate 200 mm		
Klingenlänge mm Length of blades mm	Lochanzahl No. of holes	Artikel Nr. Cat. No.
70	12	36.233.24
80	12	36.233.26
90	12	36.233.28

Passende Schrauben / Recommended Screws:	
Kortikal ø 4,5 mm	36.214.14 - 36.214.80

Orthopedic



MULTICRAFTS Corporation

Orthopedic

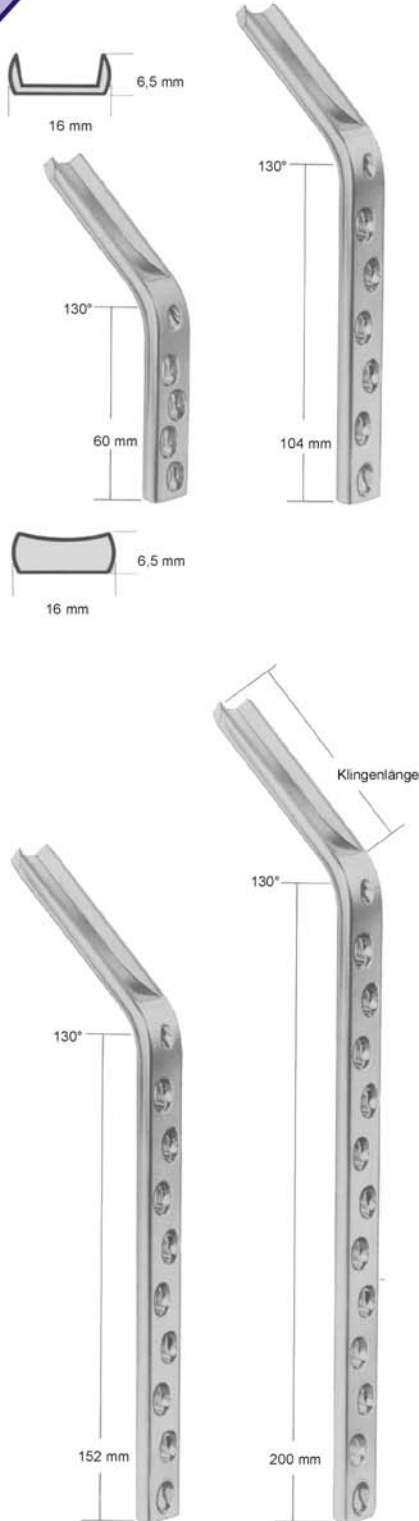

Plattenlänge 60 mm · Length of plate 60 mm		
Klingenlänge mm Length of blades mm	Lochanzahl No. of holes	Artikel Nr. Cat. No.
50	4	36.238.36
60	4	36.238.38
70	4	36.238.44
75	4	36.238.45
80	4	36.238.46
85	4	36.238.47
90	4	36.238.48
95	4	36.238.49
100	4	36.238.40
105	4	36.238.41
110	4	36.238.42

Plattenlänge 104 mm · Length of plate 104 mm		
Klingenlänge mm Length of blades mm	Lochanzahl No. of holes	Artikel Nr. Cat. No.
50	6	36.238.60
60	6	36.238.62
70	6	36.238.64
80	6	36.238.66
90	6	36.238.68

Plattenlänge 152 mm · Length of plate 152 mm		
Klingenlänge mm Length of blades mm	Lochanzahl No. of holes	Artikel Nr. Cat. No.
70	9	36.238.94
80	9	36.238.96
90	9	36.238.98

Plattenlänge 200 mm · Length of plate 200 mm		
Klingenlänge mm Length of blades mm	Lochanzahl No. of holes	Artikel Nr. Cat. No.
70	12	36.238.24
80	12	36.238.26
90	12	36.238.28

Passende Schrauben / Recommended Screws:	
Kortikal ø 4,5 mm	36.214.14 - 36.214.80



MULTICRAFTS Corporation

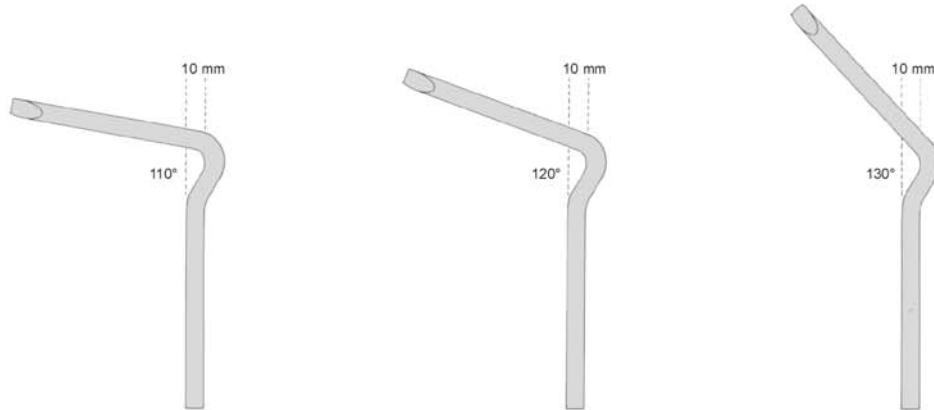

Klingenlänge mm Length of blades mm	110°	120°	130°
65	36.363.65	36.365.65	36.367.65
70			36.367.10
75	36.363.75	36.365.75	36.367.75
80			36.367.80
85	36.363.85	36.365.85	36.367.85
90			36.367.90
95			36.367.96
100			36.368.00
105			36.368.05
110			36.368.70

Passende Schrauben / Recommended Screws:	
Kortikal ø 4,5 mm	36.214.14 - 36.214.80

Orthopedic



Orthopedic

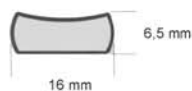
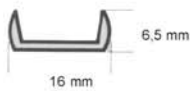
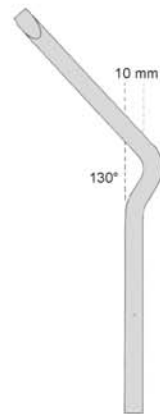
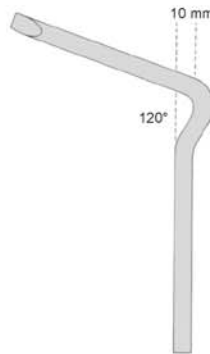
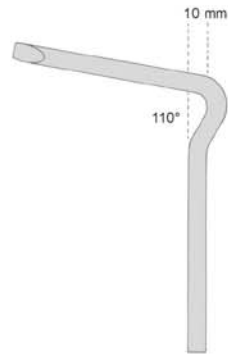

Klingenlänge mm Length of blades mm	110°	120°	130°
65	36.373.65	36.375.65	36.377.65
70			36.377.70
75	36.373.75	36.375.75	36.377.75
80			36.377.80
85	36.373.85	36.375.85	36.377.85
90			36.377.90
95			36.377.96
100			36.378.00
105			36.378.05
110			36.378.70

Passende Schrauben / Recommended Screws:	
Kortikal ø 4,5 mm	36.214.14 - 36.214.80



MULTICRAFTS Corporation

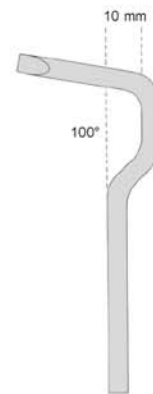
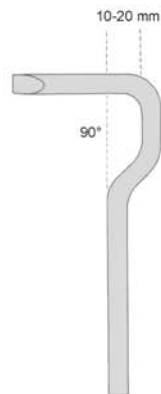

Klingenlänge mm Length of blades mm	Bogentiefe Displacement	90°	100°
40	10	36.408.40	
50	15	36.408.50	
60	15	36.408.60	
60	20	36.409.60	
60	10		36.410.60

Passende Schrauben / Recommended Screws:	
Kortikal ø 4,5 mm	36.214.14 - 36.214.80

Orthopedic



MULTICRAFTS Corporation

Orthopedic

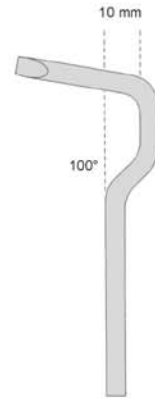
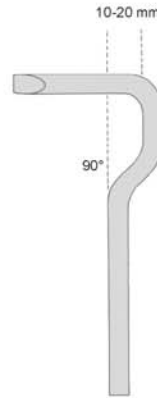

Klingenlänge mm Length of blades mm	Bogentiefe Displacement	90°	100°
40	10	36.418.40	
50	15	36.418.50	
60	15	36.418.60	
60	20	36.419.60	
60	10		36.420.60

Passende Schrauben / Recommended Screws:	
Kortikal ø 4,5 mm	36.214.14 - 36.214.80

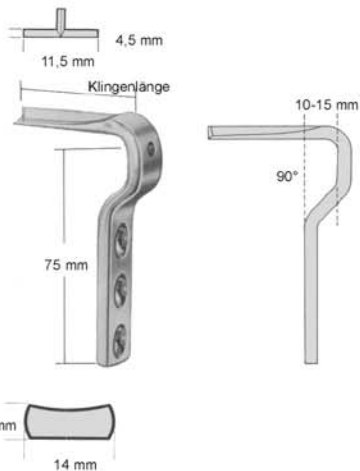

Klingenlänge mm Length of blades mm	Bogentiefe Displacement	90°
40	10	36.440.40
50	10	36.440.50
40	15	36.441.40
50	15	36.441.50

Passende Schrauben / Recommended Screws:	
Kortikal ø 4,5 mm	36.214.14 - 36.214.80



MULTICRAFTS Corporation

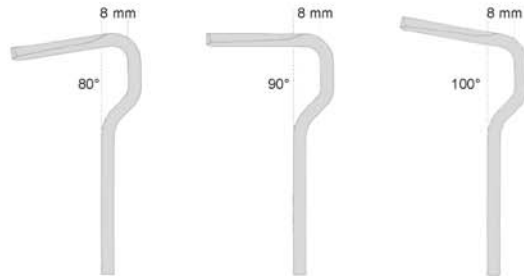

Klingenlänge mm Length of blades mm	80°	90°	100°
35	36.433.35	36.434.35	36.435.35
45	36.433.45	36.434.45	36.435.45

Passende Schrauben / Recommended Screws:	
Kortikal ø 4,5 mm	36.214.14 - 36.214.80
Malleolar ø 4,5 mm	36.215.20 - 36.215.80

Orthopedic



Klingenlänge mm Length of blades mm	Bogentiefe Displacement	90°
25	7	36.436.25
32	7	36.436.32
25	12	36.438.25
32	12	36.438.32

Passende Schrauben / Recommended Screws:	
Kortikal ø 3,5 mm	36.204.08 - 36.204.95
Spongiosa ø 4,0 mm Cancellous ø 4,0 mm	36.207.10 - 36.207.50



Orthopedic



Klingenplatten
Blade Plates

- 36.800.50 50 mm
- 36.800.60 60 mm
- 36.800.70 70 mm



Klingenmeißel
Seating Chisel



Einschlaginstrument
Final Impactor

- 33.588.21
21,0 cm / 8½"



Multicrafts

Corporation

P.O. Box 949, Sialkot 51310 - PAKISTAN

Kotli Behram, Khadim Ali Road

Tel: +92 52 426 4892 Fax: +92 52 426 4692

@: admin@multicrafts.com.pk <http://www.multicrafts.com.pk>